

Welcome



Dear Friends,

Since our establishment in 1943, we at Restaurant & Store have constantly strived to fulfill your foodservice needs. As an added convenience to our customers, we are pleased to present our new catalog. Included in this publication are many of the items that will assist you in ordering the majority of your day-to-day needs. However limited space prevents us from showing many other items that are also available. We invite you to visit our 11,000 square foot showroom, where many of the items shown in our catalog are on display.

If you are interested in any item not shown, please let us know, as our knowledgeable representatives are ready to assist you. Along with a knowledgeable sales team, we also have a complete design department, custom sheet metal fabrication department, and a parts and service department to keep you up and running.

To better serve our customers outside the immediate Salt Lake area, we provide a toll-free number for placing orders. We look forward to serving you. 1- 800-877-0087.

Restaurant & Store
700 South 230 West
Salt Lake City, UT 84101
1-800-877-0087
(801) 364-1981
Fax (801) 355-2029

Sincerely,

L. Reid Steenblik
President



Showroom



Come in and browse our spacious, 11,000 square foot showroom for the latest in equipment and supplies. Our experienced staff will provide solutions to help you meet your needs, and offer you plenty of ideas.

Custom Fabrication



We have been designing and installing custom stainless steel fabrication for fifty years. Let us bid on your counter tops, sinks, and vent hood systems.

Quick Delivery

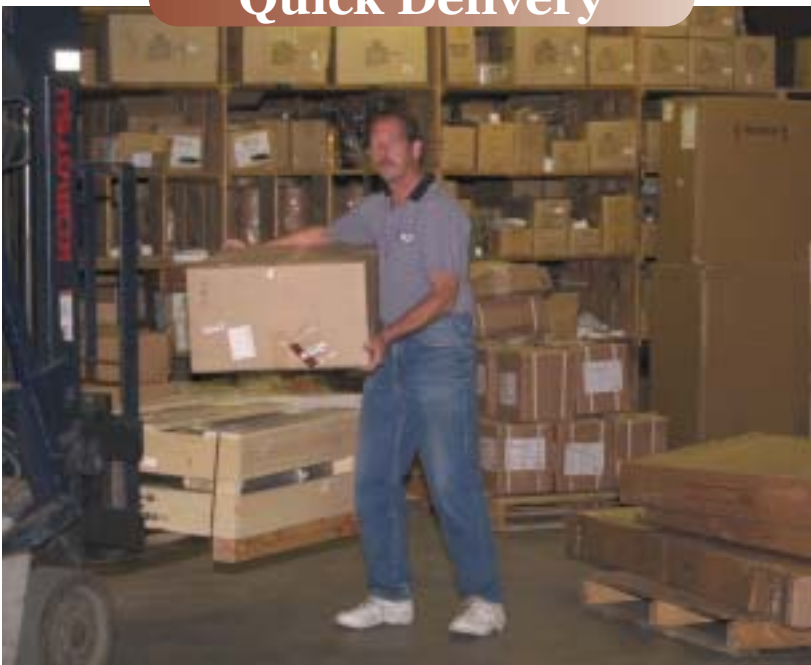

RESCO has the region's largest inventory of foodservice supplies and equipment, and in most cases we can deliver within 24 hours.

Parts & Service



With service staff on-call 24-hours a day, we can keep your equipment up and running. Fast service is just a phone call away.

Contract & Design



LeGrande Steenblik



In 1943 when Joe Steenblik started this business, one of the first things he did was to properly design kitchens for restaurants. Through the years our customers have enjoyed this service. With the addition of computer technology, our drafting and design department has grown far beyond his vision of what we could offer our customers.

We invite you to come in and get acquainted with our design people, and enjoy browsing through our showroom. We continue to provide the same quality service six decades later.





About RESCO 1

China & Dinnerware 5

Flatware 17

Glassware 25

Buffet 45

Coffee & Beverage 58

Bar Supplies 65

Tabletop 77

Pots & Pans 101

Kitchenware 115

Paper & Disposables 157

Janitorial & Chemicals 163

Equipment 175

Index 222

China & Dinnerware



WHITE ROLLED EDGE

- 21070008 #1 Grapefruit
- 21070010 #3 Nappie 10 oz
- 21070012 #4 15 oz. Nappie
- 210700329" 25 oz. Round Soup
- 210700384.5" Fruit
- 210700426.5" Plate
- 210700447" Plate
- 210700469" Plate
- 210700489.5" Plate
- 210700509.5" Platter
- 2107005210.375" Platter
- 2107005411.5" Platter
- 2107005612.5" Platter
- 210700603.5 oz. Ad Cup
- 210700624.875" Ad Saucer



BROWN SPECK

- 20231210Bouillon
- 202312127 oz. Cup
- 202312146" Saucer
- 202312168.5 oz. Mug
- 20231218Fruit Dish 4.25 oz
- 20231220Grapefruit
- 202312225.5" Plate
- 202312246.5" Plate
- 202312267.25" Plate
- 202312289" Plate
- 202312309.5" Plate
- 2023123210.5" Plate
- 202312349.5" Plate
- 20231236 #8 Platter 11.5"
- 20231238 #14 Platter 13.25"
- 20231240 #4 Nappie 5.825"

WORLD TABLEWARE INC.
A Unit of Libbey Inc.



WHITE NARROW RIM

- 21070000Bouillon Cup
- 210700027 oz. Cup
- 210700045.5" Saucer
- 210700063.5" Fruit 4.75 oz
- 210700145.5" Plate
- 210700166.5" Plate
- 210700187.25" Plate
- 210700209" Plate
- 210700229.5" Plate
- 2107002410.5" Plate
- 210700269.5" Platter
- 2107002811.5" Platter
- 2107003013.25" Platter



CASCADE

- 202014007.25 oz Bullion Cup
- 202014027.125 oz Tall tea Cup
- 202014047 oz Low Tea Cup
- 202014065 7/8" Tea Saucer
- 202014085", 3 oz Fruit Dish
- 2020141010 oz Grapefruit Bowl
- 202014126 3/8" Plate
- 202014147 3/8" Plate
- 202014169" Plate
- 2020142010 3/4" Plate
- 2020142814 oz Deep Rim Soup Bowl



CIRRUS

- 20295000 Cirrus 7.75 oz. Bouillon
- 20295012 Cirrus 7-1/8" Coupe Soup
- 20295016 Cirrus 6.375" Plate
- 20295020 Cirrus 9" Plate
- 20295024 Cirrus 10.675" Plate
- 20295026 Cirrus 11-5/8" Platter

CELEBRATE, CLUB COLORS & CLUBHOUSE



Syracuse

CHINA COMPANY
A Unit of Libbey Inc.

China & Dinnerware

RAVENNA

- 202333007 oz Unhandled Bouillon
- 202333062 oz, 5" Fruit Cup
- 202333147 5/8" Plate
- 202333169 1/8" Plate
- 2023332010 3/4" Plate



SIGNATURE COLLECTION

SIGNATURE COLLECTION



MONACO
ON REGENCY



MONACO

- 20401301Monaco 10-5/8" Plate
- 20401304Monaco 8" Plate
- 20401305Monaco 6-1/4" Plate
- 20401329Monaco 5-1/4" Fruit Bowl
- 20401330Monaco 6-1/2" Grapefruit
- 20401312Monaco 10 oz Stacking Soup
- 20401338Monaco 8 oz. Tall Cup (pictured inset)



BLACK LINE

- 20435131Blackline 5-1/2" Fruit Dish
- 20435155Blackline Low 8 oz. Teacup
- 20435158Blackline 5-3/4" Saucer
- 20435209Blackline 10-5/8" Plate
- 20435211Black line 9" Atlanta Plate
- 20435214Blackline 6-1/4" Plate
- 20435379Blackline 8 oz. Bouillon/Sugar

BIANCO

- 20402418Bianco 6" Tea Saucer
- 20402430Bianco 6-1/2" Grapefruit





SIMPLICITY

- 20405155Simplicity Low Tea Cup 8 oz.
- 20405158Simplicity 5-3/4" Saucer
- 20405209Simplicity 10-5/8" Plate
- 20405212Simplicity 8" Slimline Plate
- 20405346Simplicity 8-1/2 oz. Mug Club



ALVO ON VENITIA

- 20493505Alvo on Venitia 6-1/2" Plate
- 20493509Alvo on Venitia 10" Plate
- 20493518Alvo on Venitia 6" Saucer





FIESTA

- 20210706Fiesta Rose 10.25 oz. Mug
- 20210710Fiesta Rose 14.25 oz. Bowl
- 20210712Fiesta Rose 6.125" Plate
- 20210714Fiesta Rose 7.25" Plate
- 20210716Fiesta Rose 9" Plate
- 20210722Fiesta Rose 9.625" Platter
- 20210724Fiesta Rose 11.675" Platter
- 20210727Fiesta Cobalt Blue Platter 9.625"
- 20210900Fiesta Turquoise Bouillon Cup
- 20210906Fiesta Turquoise 10.25 oz.
- 20210908Fiesta Turquoise Pasta Bowl
- 20210912Fiesta Turquoise 6.125" Plate
- 20210914Fiesta Turquoise 7.25" Plate
- 20210918Fiesta Turquoise 10.5" Plate
- 20210924Fiesta Turquoise 11.675"



WHITE ROLLED EDGE

- 202106424.5 oz. 4.25" Fruit
- 2021064412.25 oz. 5.125" Nappie
- 202106469", 12.75 oz. Round Soup
- 202106486.25" Plate
- 202106509" Plate
- 202106529.625" Plate
- 2021065412.5" Platter
- 2021065613.375" Platter
- 2021065815.625" Platter
- 202106607.125" Plate
- 202106649.5" Platter
- 2021066610.5" Platter
- 2021066811.75" Platter
- 202106705.5" Plate
- 2021067211.625" Platter
- 2021067411" Plate
- 20210676Steven Bouillon Cup Unhandled
- 2021067813.75 oz. Soup Bowl
- 202106808.25 oz. Troy Mug
- 2021068212.25" Plate
- 2021068412" Pasta Bowl
- 202106888.25" Plate





WHITE NARROW RIM

- | | |
|--|-----------------------------------|
| 202106407 oz. Bouillon | 202106248.75" Plate |
| 202106026.75 oz. Tea Cup | 202106269.375" Plate |
| 202106048.75 oz. Mug | 202106289.75" Plate |
| 202106085.5" Saucer | 2021063810.5" Plate |
| 202106104.75" Fruit | 202106309.75" Platter |
| 202106126.375" Grapefruit | 2021063211.375" Platter |
| 202106165.625" Nappie 15 oz. | 2021063613/75" Platter |
| 202106206.5" Plate | 2021063712.5" Platter |
| 202106227.25" Plate | |

BLACK CHECKERS

- | |
|----------------------------------|
| 202105103.25 oz Fruit |
| 2021051615 oz Nappie |
| 202105469" Rim Soup |
| 202105486.25" RE Plate |
| 202105509" RE Plate |
| 2021055412.5" Platter |
| 2021057411.125" Plate |
| 2021058412" Pasta Bowl |



GREEN BAND

- | |
|---------------------------------|
| 202114165.125" Nappie |
| 202114189" Rim Soup |
| 202114206.125" Plate |
| 2021143211.125" Plate |





THE HOMER LAUGHLIN CHINA COMPANY

Ask your RESCO rep
about our many beautiful
Special Order China Patterns
from Homer Laughlin



SAVONA 8072
with Sunflower and Turquoise



AQUA MATE® 8438
with Persimmon and Turquoise



BLUE FISH 8304
with Cobalt



BOARDWALK 8435
with Turquoise, Caramel and Boardwalk
Brush Band Cup 8449



TOLON 8083
with Persimmon

China & Dinnerware



Receptions' amazingly lightweight and delicate feel and sophisticated thinness belie its enormous strength. It is resistant to mechanical and thermal shock, chipping, scratching, and scoring. This durability combined with Reception's ultra-thin stackability and its low cost make it the most economical china choice for institutional or restaurant use. Stocked in Bone White, it is also available in Gray, Black, White Undecorated, Black Band, Empire Green, Bordeaux Red, and Platinum Gray.

BONE WHITE

2021709.25" Plate

CARDINAL BONE WHITE DINNERWARE



ARCOPAL LDS CHURCH DINNERWARE

Arcopal Dinnerware is a fully tempered glass product. It is extremely durable and microwaveable. Arcopal has the look of fine china, but at affordable prices. There is no glaze and it is 100% non-porous, so no bacteria can build up. All handled items have one-piece construction.

ARCOPAL PLAIN WHITE

2024210" Plate

202307.5" Plate

202936.25" Grapefruit, 9 oz.





Hall
The Hall China Company



20225100
10 oz. White
Tea Pot



20219600
5.5 oz. White
Creamer



20236200
2.5 oz. White
Ramekin



20252700
8 oz. Brown Rarebit
20252800
12 oz. Brown Rarebit



20271602
White Packet Holder
20271600
Black Packet Holder



1192
10 oz. Brown
Handled Soup



1136
3.75 oz Sauce Boat
1138
7.75 oz Sauce Boat
1172
12 oz Sauce Boat



476
12 oz. White Onion Soup
477
9 oz Brown Onion Soup
479
14 oz Brown Onion Soup



1143
White Butter Warmer
1144
3 oz Sauce Boat



863
5 oz Souffle
864
8 oz Souffle



1959
5" Hot Pepper Shaker



1164
4.75" dia Escargot

Hall
The Hall China Company

China & Dinnerware



SERVING WARE

- A. 202003622.5 oz. White Ramekin
- B. 2023114810 oz. Onion Soup Crock
- C. 210660308 oz. White Rarebit
- C. 2106603212 oz. White Rarebit
- C. 2106603515 oz. White Rarebit



MUGS

- A. 21010204.....7 oz. Caramel Princess Mug
- B. 21070036.....8 oz. Mug
- C. 20231146.....8.5 oz. Brown Bell Shaped Mug

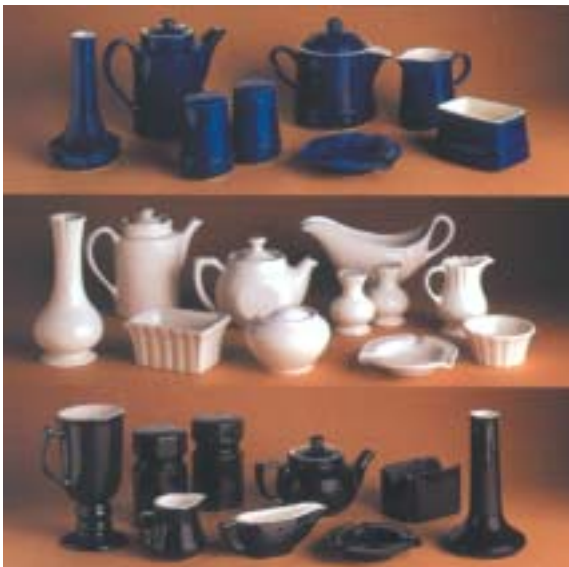

Add to the dining experience with center-of-the-table accessories from Hall China. Twenty colors are available in many of these special-order items.



WHITE RAREBIT

- 21066030.....8 oz. White Rarebit
- 21066032.....12 oz. White Rarebit



**WHITE SUGAR
PACKET HOLDER**
20200020



TABLE SKIRTING



Turn any ordinary table into a spectacular presentation with coordinating table/stage skirting and accessory items from Snap Drape. All fabrics are machine washable/dryable for easy care, and are durably flame retardant for safety.

- Burgundy and White in stock, other colors available special order
- Standard 29" high
- Snap or Velcro attachment
- Clips included
- Call for pricing on Shirred, Box or Accordion Pleats in 13', 17'6", and 21'6" sizes.



Easy Snap or Velcro attachment

HEADER STYLES



Shirred

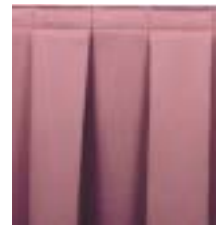

Box

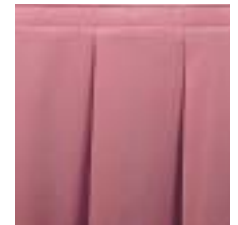

Accordion

TABLE LINENS

Signature table linens are a spun/filament polyester blend. The look and feel of cotton with the durability and strength of polyester. Excellent soil and stain release properties.

- 55520201White 20"x 20" Cloth Napkins
- 55520203Burgundy 20"x 20" Cloth Napkins
- 55520205Hunter Green 20"x 20" Cloth Napkins
- 55500901White 90" Round Tablecloth signature hemmed
- 55552114White 52"x 114" Tablecloth, signature hemmed
- 5555252White 52"x 52" Tablecloth, signature hemmed
- 55552961White 52"x 96" Tablecloth, signature hemmed

TABLE SKIRTING

- 5551329113' x 29" Shirred Pleat, White Skirt
- 5551329213' x 29" Shirred Pleat, Burgundy Skirt
- 5551729117' 6" x 29" Shirred Pleat, White Skirt
- 5551729217' 6" x 29" Shirred Pleat, Burgundy Skirt
- 5552129121' 6" x 29" Shirred Pleat, White Skirt
- 5552129221' 6" x 29" Shirred Pleat, Burgundy Skirt
- 55510000SkirtMate Hanger
- 55510001"B" Clip
- 55510002"BV" Clip
- 55510004"WV" Clip



The **Mobile Caddy** holds up to 20 Skirts on SkirtMate Hangers. Can be rolled out during set-up or break-down. Provides effective skirting maintenance and inventory control.



Special Order Colors: , Ivory, Peach, Pink, Dusty Rose, Seafoam, Red, Teal, Forest Green, Black, Sandalwood, Navy





KINGLINE™ DINNERWARE

All purpose medium-weight dinnerware meets the tough requirements of heavy duty foodservice applications. Durable gloss finish resists chipping, scratching and staining. Dishwasher safe and NSF listed. Not recommended for microwave use. Ask us about special order colors.

- | | |
|--------------------------------------|-----------------------------------|
| 57030210White Bouillon | 5703022210 oz. Nappie White |
| 57030212White Stacking Cup | 570302265.5" White Saucer |
| 570302329" White Plate | 570302286.5" White Plate |
| 570302145 oz. White Fruit | 570302307.25" White Plat |
| 570302164 oz. White Fruit | 5703023410" White Plate |
| 57030218White Grapefruit 10 oz | 505024249" Black Plate |
| 5703022014 oz. Nappie White | |



MELAMINE PLATTER

Made of heavy duty, break-resistant melamine, dishwasher safe and NSF listed. Not recommended for microwave use.

- 57030200 . .White 13-1/2 x 9-7/8"



REED & BARTON

BAGUETTE

BY REED & BARTON

- 30355001Teaspoon
 30355003Oval Dessert Spoon
 30355020Place Fork
 30355022Salad Fork
 30355030Serrated Place Knife

Baguette is an 18 chrome stainless steel pattern. Simple yet elegant.



ONEIDA®

NEEDLEPOINT

BY ONEIDA

- 30354401Teaspoon
 30354402Bouillon Spoon
 30354403Oval Bowl Spoon
 30354405Iced Teaspoon
 30354407Tablespoon
 30354420Restaurant Fork
 30354422Salad Fork
 30354423Oyster Fork
 303544311 pc. Knife w/e

FLORA BY ONEIDA

- 30310001Teaspoon
 30310002Bouillon Spoon
 30310003Dessert Spoon
 30310005Iced Teaspoon
 30310020Dinner Fork
 30310022Salad Fork
 30310023Cocktail Fork
 303100301 pc Knife w/e





**WINDSOR
BY ONEIDA**

- 30332001#320 Teaspoon
- 30332003#320 Oval Bowl Spoon
- 30332020Utility Fork
- 30332030Dinner Knife



**ACCENT
BY ONEIDA**

- 30352501Teaspoon
- 30352502Bouillon Spoon
- 30352503Oval Bowl Spoon
- 30352520Dinner Fork
- 303525311 pc. Knife w/e

ONEIDA®

**ROYAL SHELL
BY ONEIDA**

- 30338001Teaspoon
- 30338002Bouillon Spoon
- 30338020Restaurant Fork
- 30338023Oyster Fork
- 303380301 pc. Knife w/e.



HALLMARK BY ONEIDA

- 30320001Teaspoon
- 30320003Oval Bowl Spoon
- 30320002Bouillon Spoon
- 30320005Iced Teaspoon
- 30320007Tablespoon
- 30320020Restaurant Fork
- 30320022Salad Fork
- 30320023Cocktail Fork
- 303200301 pc. Knife Serrated

Flatware



VILLAGE COMMON

BY ONEIDA

- 30354001Teaspoon
- 30354002Bouillon Spoon
- 30354003Place Spoon
- 30354005Iced Teaspoon
- 30354020Dinner Fork
- 30354022Salad Fork
- 30354023Oyster Fork
- 303540301 pc Knife

ONEIDA®

CHATEAU BY ONEIDA

- 30361001Teaspoon
- 30361002Bouillon Spoon
- 30361003Oval Bowl/Soup Spoon
- 30361005Iced Teaspoon
- 30361007Tablespoon
- 30361020Restaurant Fork
- 30361022Salad/Pastry Fork
- 30361023Oyster Fork
- 303610311 pc. Knife w/e
- 30361041Hollow Handle Knife serr.



PARADE BY ONEIDA

- 30367401Teaspoon
- 30367402Bouillon Spoon
- 30367406Sundae Spoon 5"
- 30367420Restaurant Fork
- 30367422Salad Fork



ONEIDA®

FLIGHT

- 30371001.....Teaspoon
- 30371003.....Oval Bowl Soup Spoon
- 30371005.....Iced Teaspoon
- 30371020.....Dinner Fork
- 30371022.....Salad Fork
- 30371031.....Dinner Knife 1 pc.



ETAGE

- 30399901Teaspoon
- 30399902Bouillon Spoon
- 30399920Dinner Fork
- 30399922Salad Fork
- 303999311 pc. Dinner Knife



MONTE CARLO

- 30383401Teaspoon
- 303834051 ...Iced Teaspoon
- 30383402Bouillon Spoon
- 30383420Restaurant Fork
- 30383422Salad Fork
- 303834311 pc. Knife w/e
- 30383441H.H. Knife



LEXINGTON

- 30382201Teaspoon
- 30382220Dinner Fork
- 303822311 pc. Dinner Knife



LAGUNA

- 30333301Teaspoon
- 30333302Bouillon Spoon
- 30333303Dessert Spoon
- 30333305Iced Teaspoon
- 30333320Dinner Fork
- 30333322Salad Fork
- 30333330Dinner Knife



WINDSOR HEAVY WEIGHT

- 30371301Teaspoon
- 30371302Bouillon Spoon
- 30371303Dessert Spoon
- 30371305Iced Teaspoon
- 30371320Dinner Forks
- 30371322Salad Fork
- 303713311 pc. Knife

WINDSOR MEDIUM WEIGHT

- 30370301Teaspoon
- 30370302Bouillon Spoon
- 30370303Dessert Spoon
- 30370305Iced Teaspoon
- 30370306Demitasse Spoon
- 30370320Dinner Forks
- 30370322Salad Fork
- 303703311 pc. Knife



DOMINION

- 30365701Teaspoon
- 30365702Bouillon Spoon
- 30365703Dessert Spoon
- 30365705Iced Teaspoon
- 30365720Utility Fork
- 30365722Salad Forks
- 30365723Cocktail Fork
- 303657301 pc. Serrated Knife



**OLD
ENGLISH**

- 30381701Teaspoon
- 30381702Bouillon Spoon
- 30381703Dessert Spoon
- 30381705Iced Teaspoon
- 30381720Dinner Fork
- 30381722Salad Fork
- 30381723Cocktail Fork
- 303817311 pc. Knife
- 30381741H.H. Dinner Knife
- 30381742H.H. 195 Steak Knife



BACK BAY

- 30367001Teaspoon
- 30367002Bouillon Spoon
- 30367003Dessert Spoon
- 30367005Iced Teaspoon
- 30367020Dinner Fork
- 30367022Salad Fork
- 30367023Cocktail Fork
- 303670301 pc. Knife



KYLE

- 30313001Teaspoon
- 30313002Bouillon Spoon
- 30313003Dessert Spoon
- 30313005Iced Teaspoon
- 30313020Dinner Fork
- 30313022Salad Fork
- 30313030Dinner Knife

Flatware



MARQUETTE BY ONEIDA

18/8 stainless, with 18% chrome for superior resistance to food, cleaning chemicals, and corrosion, and 8% nickel for a silver-like appearance. Superbly finished for an added look of quality. Combines elegance with long-lasting durability.

- 30388201Teaspoon
- 30388202Bouillon Spoon
- 30388207Table Spoon
- 30388220Dinner Fork
- 30365720Utility Fork
- 30388222Salad Fork
- 303882311 pc. Dinner Knife

ONEIDA

WORLD TABLEWARE INC.
A Unit of Libbey Inc.

COLONY BY WORLD TABLEWARE

Heavy weight

- 30313601Teaspoon
- 30313602Bouillon Spoon
- 30313605Iced Teaspoon
- 30313620Dinner Fork
- 303136311 pc. Dinner Knife



STEAK KNIVES



- a 55575052Hardwood Handle Wave Cut Pointed
- b 55578052Poly Handle Wave Cut Pointed
- c 55579052Poly Handle Wave Cut Roundtip
- d 45039264.5" Wave Steak Knives
- e 55596052Hardwood Handle Hollow Ground

- f 55562052Poly Handle Wave Cut Jumbo
- g 55564052Hardwood Handle Pointed Wave Cut
- h 55563052Hardwood Handle Roundtip Jumbo
- i 3030527Hardwood Handle Wave Cut Jumbo

800-877-0087



DINNERWARE SERVICE GUIDE FOR 100 PEOPLE

	Hotels & Restaurants	Coffee Shops	Cafeterias	Caterers & Churches	Hospitals & Nursing Homes	Schools & Colleges
Cups & Saucers	15 Doz	15 Doz	12 Doz	12 Doz	12 Doz	3 Doz
Bouillon/Sugar	6-9 Doz	3-6 Doz	6 Doz	12 Doz	6-9 Doz	-
Plates (5-1/2")	12 Doz	-	-	12 Doz	18 Doz	-
Plates (6-1/2" - 7")	12 Doz	18-24 Doz	15 Doz	12 Doz	-	12 Doz
Plates (8" - 9")	6 Doz	12 Doz	12 Doz	12 Doz	15 Doz	12 Doz
Plates (9-1/2" - 10-1/2")	10 Doz	3 Doz	-	12 Doz	-	-
Bowls (10 - 16 oz)	3 Doz	6 Doz	6 Doz	-	6-9 Doz	9 Doz
Grapefruits	3 Doz	3 Doz	-	-	6-9 Doz	-
Fruit Saucers	12 Doz	12 Doz	12 Doz	12 Doz	12 Doz	12 Doz
Teaspoons	18 Doz	18 Doz	18 Doz	18 Doz	18 Doz	18 Doz
Dessert/Soup Spoons	6 Doz	12 Doz	12 Doz	12 Doz	12 Doz	12 Doz
Tablespoons	3 Doz			3 Doz		
Iced Drink Spoons	3 Doz	6 Doz	6 Doz			
AD Coffee Spoons	3 Doz					
Bouillon Spoons	6 Doz					
Forks	12 Doz	12 Doz	18 Doz	12 Doz	18 Doz	12 Doz
Salad/Pastry Forks	12 Doz	12 Doz		12 Doz		
Cocktail Oyster Forks	6 Doz	3 Doz				
Dinner Knife	12 Doz	12 Doz	12 Doz	12 Doz	12 Doz	12 Doz
B/B Knife	12 Doz					
Steak Knife	6 Doz	3 Doz				
Water Tumbler/Goblet	12 Doz	18 Doz	12 Doz	12 Doz		
Juice Glass	6 Doz	12 Doz	6 Doz	12 Doz	12 Doz	6 Doz
Iced Tea Glass	6 Doz	6 Doz	6 Doz	12 Doz		
Milk Glass	6 Doz	12 Doz	6 Doz		6 Doz	6 Doz

Libbey®

NAPPA COUNTRY



FLUTE
12508795
8795 6 oz.
H7-7/8 T1-7/8 B2-5/8
D2 5/8



GOBLET
12508756
8756 10 oz.
H7-1/8 T2-5/8
B2-3/4 B3



WHITE WINE
8764 8 oz.
H6-3/4 T2-3/8
B2-5/8 D2-3/4



Ask us about special order non-stock glassware.

CHIVALRY



COOLER
12502486
2486 16 oz.
H6-1/8 T3
B2-3/8 D3-1/4



GOBLET
12503211
3211 10.5 oz.
H5-3/8 T2-7/8
B2-3/4 D3-1/4



GOBLET
13211HT 10 oz.
H5-3/8 T2-7/8
B2-3/4 D3-1/4



GOBLET
13212HT 12 oz.
H6-1/2 T3-1/4
B3 D3-5/8



BEVERAGE
12512488
12488HT 12 oz.
H5-1/4 T2-7/8
B2-1/4 D3-1/8

COCKTAIL & SPECIALTY



COCKTAIL
12508882
8882 4.5 oz.
H5-7/8 T3-5/8 B3
D3-5/8



CACTUS MARGARITA
12503619JS
3619JS 12 oz.
H6-1/8 T3-3/4
B3 D4



SQUALL
12503616
3616 15 oz.
H8-1/4 T3-1/8
B3 D3-1/8

ESTATE



WINE
3369 6.5 oz.
H5-1/2 T2-7/8
B2-3/4 D3-1/8



GOBLET
12503311
3311 11.5 oz.
H7 T2-3/4
B2-7/8 D3-5/8



CITATION



PILSNER
12508425
8425 12 oz.
H8-1/4 T3 B3 D3



BRANDY
8409 22-1/2 oz.
H5-1/2 T3
B3 D4-3/8



COCKTAIL
12508454
8454 4-1/2 oz.
H5-5/8 T3-1/2
B2-7/8 D3-1/2



COCKTAIL
12508455
8455 6 oz.
H5-7/8 T4-1/4
B2-7/8 D4-1/4



BURGUNDY WINE
12508471
8471 9 oz.
H5-5/8 T2-3/4
B2-3/4 D3-1/4



WHITE WINE
12508472
8472 11 oz.
H6-7/8 T2-5/8
B2-3/4 D3-1/4



RED WINE
12508414
8414 12-1/2 oz.
H5-7/8 t3
B2-3/4 D3-7/8



WINE/BEER
12508464
8464 8 oz.
H6-3/4 T2-3/4
B2-1/2 D2-7/8



ROUND WINE
12508469
8469 6-1/2 oz.
H5-3/4 T2-5/8
B2-1/2 D2-7/8

CITATION GOURMET



TALL DUTCH CORDIAL
8491 1-1/2 oz.
H6-1/4 T1-7/8
B2 D2



COUPETTE MARGARITA
12508429
8429 9 oz.
H6-1/8 T4-1/2
B3 D4-1/2



ROUND WINE
12508415
8415 14 oz.
6-5/8 T3-1/4
B3 D4



TULIP CHAMPAGNE
12508476
8476 9 oz.
H8-1/2 T2-1/4
B2-3/4 D2-3/4



TALL WINE
12508412
8412 12 oz.
H7-7/8 T2-1/8
B2-3/4 D 2-3/4



GRANDE



VINO GRANDE
12508416
8416 16 oz.
H8-7/4 T3 B3 D3-5/8



FIESTA GRANDE
12508417
8417 16-3/4 oz.
H6-1/4 T4-3/4
B3 D5



FIESTA GRANDE
12508422
8422 15-1/4 oz.
H6-1/8 T4-7/8
B3 D5



FIESTA GRANDE
12508423
8423 12 oz.
H6 T4-1/8
B3-1/8 D4-1/2

Glassware

TEARDROP



VINO GRANDE
12508420
8420 19-1/2 oz.
H8-1/2 T3-1/8
B3 D3-7/8



BOLLA GRANDE
12508418
8418 16-1/2 oz.
H6-7/8 T3-5/8
B3-1/4 D4-3/8



SALUD GRANDE
12508480
8480 10 oz.
H6-7/8 T4-3/4
B3 D4-3/4



RED WINE
3969 6-1/2 oz.
H5-3/4 T2-5/8
B2-5/8 B3



RED WINE
12503964
3964 8-1/2 oz.
H6-1/2 T2-3/4
B2-7/8 B3-1/4



WHITE WINE
12503966
3966 6-1/2 oz.
H6-1/4 T2-3/8
B2-5/8 D2-3/4



WHITE WINE
12503965
3965 8-1/2 oz.
H7-1/8 T2-5/8
B2-3/4 D3



GOBLET
12503914
3914 10-1/2 oz.
H5-1/2 T3
B2-3/4 D3-1/4



GOBLET
12503911
3911 12 oz.
H7-1/4 T2-7/8
B2-7/8 D3-3/8



FLUTE
12503996
3996 6-1/2oz.
H7-3/4 T2
B2-3/4 D2-3/4



Libbey[®]

EMBASSY



BRANDY
12503702
3702 5-1/2 oz.
H4-1/8 T2
B2-3/4 D2-7/8



BRANDY
12503704
3704 9 oz.
H4-1/2 T2-1/4
B2-1/2 D3-3/8



BRANDY
12503705
3705 12 oz.
H5 T2-1/4
B2-3/4 D3-5/8



BRANDY
12503708
3708 17-1/2 oz.
H5-1/2 T2-5/8
B2-3/4 D4



GOBLET
12503711
3711 11-1/2 oz.
H6-1/8 T2-7/8
B2-3/4 D3-1/4



GOBLET
12503712
3712 10-1/2 oz.
H5-1/4 T2-7/8
B2-7/8 D3-1/8



GOBLET
12503752
3752-HT 10-1/2 oz.
H5-1/4 T2-7/8
B2-7/8 D3-1/8



**FOOTED
HI-BALL**
12503736
3736 8 oz.
H5-3/8 T2-3/4
B3-3/4 D2-7/8



**FOOTED
ROCKS**
12503746
3746 5-1/2 oz.
H4-1/8 T3-1/8
B2-3/4 D3-1/8



BEER
3728 12 oz.
H7-1/8 T2-1/2
B2-3/4 D2-7/8



WINE
12503757
3757 10-1/2 oz.
H6 T3-1/8
B2-3/4 D3-3/8



WINE
12503764
3764 8-1/2 oz.
H5-5/8 T2-7/8
B2-3/4 D3-1/8



WINE
12503765
3765 8-1/2 oz.
H6-3/8 T2-3/8
B2-1/4 D2-3/4



WINE
12503766
3766 6-1/2 oz.
H6-1/4 T2-1/8
B2-5/8 D2-5/8

EMBASSY



CHAMPAGNE

3787 3-1/2 oz.
H4-1/2 T3-1/4
B2-3/4 D3-3/8



FLUTE

12503795
3795 6 oz.
H8-1/8 T2
B2-3/4 D2-1/8



TALL FLUTE

12503796
3796 6 oz.
H8-3/4 T2
B2-3/4 D2-3/4

Glassware

Libbey®



WINE

12503769
3769 6-1/2 oz.
H5-3/8 T2-5/8
B2-1/2 D2-7/8



CHAMPAGNE

12503773
3773 5-1/2 oz.
H4-1/2 T3-1/4
B2-3/4 D3-3/8

EMBASSY ROYALE



ICED TEA

12503716
3716 16 oz.
H7 T3-1/4
B3 D3-1/2



POCO GRANDE

12503717
3717 13-1/4 oz.
H7 T2-2/8
B3 D3-5/8



POCO GRANDE

12503715
3715 10 oz.
H7 T2-5/8
B2-7/8 D3-1/8



FOOTED ALE

12503812
3812 12 oz.
H6-1/2 T2-3/4
B2-3/4 D3



FOOTED ALE

12503810
3810 10 oz.
H6-1/2 T2-5/8
B2-3/4 D2-7/8

CATALINA



CORDIAL

12503826
3826 2 oz.
H4-5/8 T1-5/8
B2 D2



PILSNER

12503828
3828 12 oz.
H9 T2-5/8
B3 D2-5/8



TALL BEER

12503823
3823 14 oz.
H9-3/8 T2-3/4
B3-1/4 D2-3/4



FOOTED ALE

3815 14 oz.
H8-3/4 T2-3/4
B3 D3-1/4



NAPOLI GRANDE

1619 15-1/2 oz.
H8-3/4 T2-3/4
B3 D3-1/4



COMET



WATER
12518101
18101HT 8-3/4 oz.
H4-1/8 T2-5/8
B2-1/2 D2-5/8



ICED TEA
12518061
18061HT 12 oz.
H5-3/8 T2-5/8
B2-5/8 D2-3/4

NO-NIK



WATER
12501910
1910HT 10 oz.
H3-7/8 T2-3/4
B2-5/8 D2-7/8



ICED TEA
12501906
1906HT 12 oz.
H5-1/8 T2-5/8
B2-1/2 D2-3/4

LEXINGTON



JIGGER
12502303
2303 3 oz.
H2-5/8 T2
B2 D2



TALL HI BALL
2310 10 oz.
H6 T2-1/2
B2-1/2 D2-1/2



OLD FASHIONED
12502328
2328 7-3/4 oz.
H3-1/2 T2-7/8
B2-3/4 D2-7/8



OLD FASHIONED
12502338
2338 10-1/2 oz.
H3-1/2 T3-1/4
B3-1/8 D3-1/4



DOUBLE OLD FASHIONED
12502339
2339 12-1/2 oz.
H4 T3-1/4
B3-1/8 D3-1/4

NOB HILL



BEVERAGE
12523596
23596 11-1/2 oz.
H5 T2-3/4
B2-3/4 D2-2/4



OLD FASHIONED
12523286
23286 7-3/4 oz.
H3-1/2 T2-3/4
B2-3/4 D2-7/8



DOUBLE OLD FASHIONED
12523396
23396 12-1/4 oz.
H3-7/8 T3-1/8
B3-1/3 D3-1/4

GIBRALTER



COOLER
12515235
15235 12 oz.
H5-7/8 T3-1/8
B2-1/4 D3-1/8



COOLER
12515256
15256 16 oz.
H6-3/8 T3-3/8
B2-1/2 D3-5/8



GIBRALTER



Hi BALL
12515236
15236 9 oz.
H4-1/4 T3-1/8
B2-1/2 D3-1/8



Hi BALL
12515239
15239 7 oz.
H4-1/2 T2-5/8
B2-1/4 D2-5/8



Hi BALL
12515237
15237 10 oz.
H4-3/4 T3-1/8
B2-1/2 D3-1/8



Rocks
12515248
15248 4/5 oz.
H3-1/8 T3
B2-1/8 D3



Rocks
12515249
15249 5-1/2 oz.
H3-1/8 T3
B2-1/8 D3



Rocks
12515240
15240 8 oz.
H3-5/8 T3-3/8
B2-1/2 D3-3/8



Rocks
12515241
15241 7 oz.
H3-1/4 T3-1/8
B2-1/4 D3-1/8



Rocks
12515242
15242 9 oz.
HH3-5/8 T3-3/8
B2-1/2 D2-3/8



BEVERAGE
12515244
15244 14 oz.
H5-1/8 T3-1/2
B2-3/4 D3-1/2



BEVERAGE
12515238
15238 12 oz.
H4-7/8 T3-1/4
B2-5/8 D3-1/4



ICED TEA
12515253
15253 22 oz.
H7 T3-3/4
B2-3/4 D3-3/4



Rocks
12515232
15232 10 oz.
H3-7/8 T3-1/2
B2-1/2 D3-1/2



Rocks
12515243
15243 12 oz.
H4 T3-5/8
B2-3/4 D3-5/8



Libbey®

WINCHESTER



HI BALL
12515451
15451 7 oz.
H4-5/8 T2-5/8
B1-7/8 D2-5/8



HI BALL
12515456
15456 9 oz.
H5 T2-3/4
B2 D2-3/4



BEVERAGE
12515458
15458 12-1/2 oz.
H5-3/8 T3
B2-1/8 D3



COOLER
12515459
15459 16 oz.
H5-7/8 T3-1/4
B2-3/8 D3-1/4

GOVERNOR CLINTON



WINE
15463 6-1/2 oz.
H5-1/4 T2-5/8
B2-1/2 D2-3/4



WINE
12515464
15464 8-1/2 oz.
H5-5/8 T2-7/8
B2-3/4 D3



GOBLET
12515465
15465 10-1/2 oz.
H6 T3-1/4
B2-7/8 D3-3/8



JUICE
12500633
633HT 5 oz.
H3-3/4 T2-2/8
B1-3/4 D2-1/4



MILK
12500618
618HT 8 oz.
H3-5/8 T2-5/8
B2-3/8 D2-3/4



WATER
12500610
610HT 9-1/2 oz.
H3-7/8 T2-5/8
B2-1/2 D2-7/8



COLLINS
608HT 10 oz.
H4-5/8 T2-1/2
B2-1/4 D2-3/4



ICED TEA
12500606
606HT 12 oz.
H5-1/8 T2-1/2
B2-3/8 D2-7/8



LEMONADE
12500603
603HT 14 oz.
H5-3/8 T2-5/8
B2-3/8 D3



SODA
12501713
1713HT 16 oz.
H6-3/8 T3
B2-1/8 D3-1/4

HEAVY BASE



OLD FASHIONED
12500128
128 9 oz.
H3-1/4 T3-3/8
B2-5/8 D3-3/8



ENGLISH HI BALL
12500139
139 13 oz.
H4 T3-5/8
B2-3/4 D3-5/8



SIDE WATER
12500149
149 5 oz.
H3-1/2 T2-3/8
B2-1/8 D2-3/8



HI BALL
12500132
132 8 oz.
H4-5/8 T2-5/8
B2-1/8 D2-5/8



HI BALL
12500133
133 9 oz.
H5 T2-3/4
B2 D2-3/4

ROOM TUMBLER



HI BALL
12500172
172 10.5 oz.
H5-1/8 T2-3/4
B2-3/8 D2-7/8



COLLINS
12500126
126 11 oz.
H5-1/4 T2-7/8
B2-3/8 D2-7/8



SPLIT
12500151
151 6 oz.
H4 T2-3/8
B2-1/8 D2-3/8



BEVERAGE
12500159
159 12.5 oz.
H5-5/8 T2-7/8
B2-1/2 D2-7/8



ROOM TUMBLER
12500135
135 8 oz.
H3-5/8 T2-3/4
B2-5/8 D2-3/4

STRAIGHT SIDED



ZOMBIE
12500096
96 12 oz.
H6 T2-1/2
B2-1/4 D2-1/2



ICED TEA
551HT 12.5 oz.
H5-1/4 T2-3/4
B2-3/8 D2-7/8



COLLINS
12500553
553HT 10 oz.
H4-3/4 T2-5/8
B2 1/4 D2-3/4



CORDIAL
12501650SR
1650SR 2.5 oz.
H4-1/8 T1-1/2
B1-3/8 D1-1/2



BEVERAGE
12501661SR
1661SR 12 oz.
H6-5/8 T2-1/2
B2-1/4 D2-1/2

SHEER RIM



CASCADE



JUICE
12529011
29011HT 6 oz.
H3-1/2 T2-3/8
B2-3/8 D2-1/2



WATER
12529211
29211HT 10 oz.
H4-1/4 T2-3/4
B2-3/4 D2-7/8



GOLD WATER
12529211K
29211KHT 10 oz.
H4-1/4 T2-3/4
B2-3/4 D2-7/8



BEVERAGE
12529411
29411HT 12 oz.
H5-3/8 T2-3/4
B2-5/8 D2-3/4



GOLD BEVERAGE
12529411K
29411KHT 12 oz.
H5-3/8 T2-3/4
B2-5/8 D2-3/4



BEVERAGE
12529511
29511HT 8 oz.
H3-3/4 T2-3/4
B2-5/8 D2-3/4



GOLD MILK
12529511K
29511K 8 oz.
H3-3/4 T2-3/4
B2-5/8 D2-3/4



COOLER
12529811
29811 16 oz.
H6 T2-7/8
B2-3/8 D3



GOLD COOLER
29811K 16 oz.
H6 T2-7/8
B2-3/8 D3

SPECIALTY



COOLER
12532802
32802 16 oz.
H6-3/4 T2-3/4
B2-5/8 D2-7/8

ESQUIRE



HI BALL
12500225
225 9 oz.
H5 T2-1/2
B2-1/2 D2-5/8

MALIBU GOLD



ICED TEA
12547411K
47411KHT 12 oz.
H5-3/8 T2-7/8
B2-1/2 D2-7/8



WATER
12547211K
47211K 10.25 oz.
H4-1/4 T3
B2-5/8 D3

TUMBLER



OLD FASHIONED
12505131
5131 4 oz.
H3-1/8 T2-7/8
B2-1/4 D2-7/8



HOURLASS PILSNER



PILSNER
12501176
1176HT 9 oz.
H5-3/8 T2-3/4
B2-3/8 D2-7/8



PILSNER
12501178
1178HT 10 oz.
H5-3/4 T2-3/4
B2-3/8 D2-3/4



PILSNER
12501179
1179HT 11 oz.
H6 T2-3/4
B2-3/8 D2-7/8



PILSNER
12501181
1181HT 12 oz.
H6 T3-1/8
B2-5/8 D3-1/4



GIANT BEER
12501610
1610 23 oz.
H9-1/4 T3-1/2
B2-3/4 D3-1/2



MIXING GLASS
12501639
1639HT 16 oz.
H5-7/8 T3-1/2
B2-3/8 D3-1/2



MIXING GLASS
12515141
15141 14 oz.
H5-7/8 T3-1/2
B3-3/8 D3-1/2

PILSNER



**BULGE TOP
PILSNER**
12500014
14 12 oz.
H6-1/4 T2-7/8
B2-1/2 D3-1/8



FLARE PILSNER
12500019
19 12 oz.
H7-1/4 T3-1/8
B2-1/2 D3-1/4



**ENGLISH PUB
GLASS**
12514801
14801HT 20 oz
H6 T2-3/8
B2-5/8 D3-1/2



**ENGLISH PUB
GLASS**
14806HT 16 oz
H5-7/8 T3-1/8
B2-1/4 D3-1/4



PUB GLASS
194 15-1/2 oz.
H6-5/8 T3-1/8
B2-1/2 D3



PUB GLASS
12500197
197 22 oz.
H7-1/4 T2-7/8
B2-1/2 D3-1/4



HOFFMAN HOUSE
12505210
5210 Goblet 10 oz.
H6-1/8 T4
B3-1/4 D4



HANDLED MUG
12505011
5011 15 oz.
H5 1/2 T3
B3 5/8 D4 1/2



HANDLED MUG
12505012
5012 12-1/2 oz.
H5-1/2 T2-7/8
B2-3/8 D4-1/2



PANELED MUG
12505018
5018 14 oz.
H6-1/8 T3-1/2
B3-1/2 D5



PANNELED MUG
12505020
5020 16 oz.
H6-1/4 T3-1/2
B3-1/2 D5-1/8



FRANKFURT MUG
12505001
5001 22 oz.
H9 T3
B3-3/8 D4-3/8



BEER MUGS



STEIN
12505206
5206 12 oz.
H5-7/8 T2-7/8
B3-1/4 D4-1/2



PRESSED MUG
12505202
5202 10 oz.
H5-5/8 T3-1/8
B2-1/2 D5-5/8



CRYSTAL MUG
12505203
5203 11 oz.
H5-7/8 T3-1/8
B2-3/4 D5-3/4



MUNICH STEIN
5312 14-1/2 oz.
H5-7/8 T3-1/2
B3-1/2 D5-1/8



SUPER MUG
12505262
5262 1 Liter
H8 T4
B4 D6



SUPER MUG
12505272
5272 25 oz.
H7-1/8 T3-5/8
B3-5/8 D5-5/8



SCANDINAVIA MUG
12505298
5298 15 oz.
H6-1/4 T3-5/8
B3-1/2 D5-1/8



BOOT MUG
97036 1/2 Litre/16 oz.
H6-1/2 T3-1/4
B3-7/8 D5-5/8



DRINKING JAR
12597085
97085 16 oz.
H5-1/4 T2-5/8
B2-1/2 D4-1/8

WHISKEY SERVICE

Glassware



TALL WHISKEY

5031 1 oz.
H2-7/8 T1-3/4
B1-1/4 D1-3/4



WHISKEY

12505121
5121 1-1/4 oz.
H2-3/8 T2
H1-3/8 D2



WHISKEY

12505120
5120 1-1/2 oz.
H2-3/8 T2
B1-3/8 D2



PLAIN WHISKEY

12505122
5122 1 oz.
H2-3/8 T2
H1-3/8 D2



FLUTED WHISKEY

12505126
5126 2 oz.
H2-7/8 T2-1/4
H1-3/4 D2-1/4



LINED WHISKEY

125051261
5126-A0007 1 oz.
H2-7/8 T2-1/4
H1-3/4 D2-1/4



FLUTED WHISKEY

12505127
5127 1-1/2 oz.
H2-7/8 T2-1/4
H1-3/4 D2-1/4



FLUTED WHISKEY

12505126
5126 2 oz.
H2-7/8 T2-1/4
H1-3/4 D2-1/4



FROSTED CLEAR LIP

ZOMBIE FROSTER

96-11680 12 oz.
H6 T2-1/2
B2-1/4 D2-1/2



ZOMBIE FROSTER

115-11680 13-1/2oz.
H7 T2-1/2
B2-1/4 D2-1/2

WARM BEVERAGE MUGS



CRYSTAL MUG

12505201
5201 10 oz.
H3-1/2 T3-1/8
B2-3/4 D4-1/2



IRISH COFFEE

12505295
5295 8.5 oz.
H5-7/8 T3-1/8
B2-3/4 D4-1/8



IRISH MUG

12505293
5293 8-1/4 oz.
H5-7/8 T3
B2-7/8 D3-5/8



PEDESTAL IRISH

5292 8.5 oz.
H6-3/8 T2-3/8
B2-3/4 D3-5/8

Libbey[®]



**ARTIC TUMBLERS
& STEMWARE**



arcoroc

ARTIC TUMBLERS

- 13051000 HiBall 8.75 oz.
H4-3/4 T2-5/8 B2
8003725
- 13051008 Beverage 12.5 oz.
H5-3/8 T2-7/8 B2-1/4
8004103

ARTIC STEMWARE

- 13051014 Goblet 10.5 oz.
H5-3/4 T3-1/8 B2-7/8
8004616
- 13051016 Wine 5.5 oz.
H4-3/4 T2-5/8 B2-1/2
8004772
- 13051012 Champagne 6.5 oz.
H4-1/8 T3-5/8 B2-7/8
8004483

**EXCALIBUR STEMWARE
& TUMBLERS**

- 13051058 Banquet Goblet 11.5 oz.
H5-1/4 T3 B2-7/8 M3-3/8
8071078
- 13051064 Iced Tea 16.5 oz.
H7-5/8 T2-1/4 B3 M3-1/4
8012926

EXCALIBUR STEMWARE & TUMBLERS



arcoroc

EXCALIBUR OPTIC



arcoroc

EXCALIBUR OPTIC

- 13051062 Banquet Goblet 11-1/2 oz H5-1/4 T3 B2-7/8M3-3/8
8013194

Glassware



BEER PITCHER
12505260
5260 60 oz.
H9-1/4 T5-3/4
B4-1/8 D7-7/8



1 LITER CARAFE
12597000
97000
H10-7/8 T3-1/2
B3-3/4 D3-3/4



**BEER WAGON
PITCHER**
13000224
1155UAH 55 oz.
H9-1/8 T5-1/2
B4 D7



BOOT MUG
13000230
162U 12-1/2 oz.
H6 T2 7/8
B4 X 2-1/4
D5-1/4



FESTIVE COOLER
3080 15-1/4 oz.
H6-7/8 T2-7/8
B2-3/8 D3



**WEXFORD PUNCH
BOWL**
4570EU



PUNCH CUP
13000108
279 6 oz.
H2-3/8 T3-3/8
B1-3/4 D4-1/4



**CRUET &
STOPPER**
13000106
171F 6-1/4 oz.
H5-1/4 T1-1/4
B2-1/2 D3-5/8



**WAVERLY
SHERBET**
13000210
56E 5 oz.
H2-1/2 T3-3/4
B2-1/8 D3-3/4



FOOTED DESSERT
13000282
513 13 oz.
H4-7/8 T5-1/2
B3-1/2 D5-1/2



**MASON JAR
SALT & PEPPER
SHAKER**
13000270
6021 4 oz.
H3-3/8 T1-7/8
B1-6/8 D3



SALAD PLATE
13000114
842U
8"



SHERBET PLATE
13000112
828
6"



MOMENTS PLATE
13000142
1345
9"



SHERBET
12505161

5161 3-1/2 oz.
H2-7/8 T3-1/8
B2-3/8 D3-1/8



SHERBET
12505162

5162 4-1/2 oz.
H3-1/8 T3-1/8
B2-5/8 D3-1/2



SHERBET
12505102

5102 3-1/2 oz.
H2-1/4 T3-3/4
B2-3/4 D3-3/4



SHERBET

5103 4-1/2 oz.
H2-3/8 T4-1/8
B3 D4-1/8



SUNDAE
12505314

5314 5-1/4 oz.
H5-7/8 T4-1/4
B3-1/8 D4-1/4



BANANA SPLIT

12505317
5317 9"
H1-7/8 T9
B5 D9



TULIP SUNDAE

12505115
5115 6-1/2 oz.
H4-7/8 T4
B3 D4



SUPREME LINER

12505119
5119 5 oz.
H1-3/4 T3-3/4
B1-5/8 D3-3/4



SUPREME

12505118
5118 17 oz.
H4-1/2 T5-1/8
B4 D5-1/8



**OYSTER
COCKTAIL**

12505160
5160 2-1/2 oz.
H1-7/8 T2-1/2
B1-3/4 D2-1/2



SODA

12505310
5310 11-1/2 oz.
H7-1/8 T3-1/4
B3-1/8 D3-1/8



SODA

12505110
5110 12 oz.
H7-1/2 T3-1/8
B3-1/8 D3-1/8



**SUGAR PACKET
HOLDER**

12505460
5460
H2-1/8 T4-1/4
B3-7/8 D4-1/4



**SUGAR PACKET
HOLDER**

12505258
5258
H2-1/8 T3-1/2
B3-1/2 D2-3/8



VOTIVE
12501965

1965 4-3/4 oz.
H2-1/2 T2-1/8
B1-3/8 D2-5/8





Glassware



GLASS PLATTER
12505525
5525
13"



GLASS SALAD PLATE
12505335
5335
6"



RAMEKIN
12515445
15445 1.5 oz.
H1-7/8 T2-3/8
B1-7/8 D3



RAMEKIN
12515446
15446 3 oz.
H1-3/8 T3
B2-1/4 D3



DAISY BUTTON BOWL
12565606
65606
11 qt. Bowl Only



NOB HILL ASH TRAY
12505154
5154
4"



SQUARE ASH TRAY
5044
4 5/8"



SAFETY ASH TRAY
12505164
5164
5"



3-PIECE CRUET SET
12580371
80371 6 oz. ea.
H7-5/8 -1/8
B7 D7



S/S TOP SHAKER
12597052
97052 2 oz.
H4-1/8 T1-1/2
B1-1/2 D1-1/2



CHROME PLATE BRASS TOP SHAKER
12570022
70022 1-1/2 oz.
H4-1/8 T1 B2 D2
12596021 Tops Only



CHROME PLATE PLASTIC TOP
12505221
5221 1-1/4 oz.
H3-7/8 T1-5/8
B1-5/8 D1-3/4



CHROME PLATE PLASTIC TOP
12505037
5037 1-1/2 oz.
H4-1/8 T1-5/8
B1-5/8 D2-1/4



ALUMINUM TOP SHAKER
12505045
5045 2 oz.
H3-1/8 T1-1/4
B1-1/2 D1-5/8



COSMOS



DINNER PLATE

80-10980 9-1/8"
3 dz. 34 lb.

SOUP/DEEP SALAD PLATE 1308000010

80-10980 9-1/8"
3 dz. 34 lb.

MULTI PURPOSE BOWL

80-00051 8"
4 dz. 44 lb.

SALAD PLATE

80-00036 8"
3 dz. 23 lb.

DESSERT PLATE

80-00044 7"
6 dz. 35 lb.

12-7/8" PLATE

1308006558
(not shown)
80-6558 12-7/8"
6 pc. 14 lb.



FLEUR

13051030.....8007510 9" Dinner Plate
13051042.....8007577 10-7/8" Plate
13051052.....8066801 5-1/2" Plate
13051032.....8009423 7-1/2" Dessert Plate
13051038.....8057375 5" 10-1/2 oz. Bowl
13051050.....8058917 6-3/8" Bowl
13051044.....8007684 8" Soup/Salad
13051034.....8007432 7" 32 oz. Bowl
13051036.....8008112 9" 70 oz. Bowl

ARCADE BOWLS



9" BOWL

80-00515
72 oz.
1 dz. 24 lb.

8" BOWL

80-43830
48 oz.
1 dz. 16 lb.

7" BOWL

80-00531
38 oz.
2 dz. 28 lb.

6" BOWL

80-00549
22 oz.3
1 dz. 25 lb.

5" BOWL

80-00556
11 oz.
12 dz. 51 lb.

4" BOWL

80-49698
5-1/2 oz.
3dz. 9 lb.

TEARDROP BEER



Libbey®



BEER

3328 12 oz.
H7-1/8 T2-1/2
B2-3/4 D3-1/2

DECANTER/VASE

719 6 oz.
H4-7/8 T1-7/8
B2 D2-3/4

GIBRALTER



COOLER

12515651
15651 16 oz.
H6-1/2 T3-1/4
B2-1/2 D3-1/4



BEVERAGE

12515654
15654 12 oz.
H5 T3-1/2
B2-3/4 D3-1/2



HI-BALL

12515236
15236 9 oz.
H4-3/4 T3-1/2
B2-1/2 D3-1/2



ROCKS

12515661
15661 7 oz.
H3-1/8 T3-1/8
B2-1/8 D3-1/8

GIBRALTER



WINE

12515246
15246 8-1/2 oz.
H6-1/4 T3-1/2
B3 D3-1/2



GOBLET

12515247
15247 11-1/2 oz.
H6-7/8 T3-3/8
B3-1/8 D3-5/8



GIBRALTER

ASHTRAY
12505172
5172 4" dia.



GLASS MUGS

- 130181010 oz. Mug, 5-1/8"H
- 130181212 oz. Mug, 5-5/8"H
- 130181414 oz. Mug, 5-7/8"H
- 130181616 oz. Mug, 5-7/8"H



HOFFMAN HOUSE GOBLETs

- 641212 oz. H.H., 6-1/4"H
(special order)



WEISS GOBLETs

- 130321218 oz. Weiss, 7-1/2"H
- 130733832 oz. Weiss, 8"H



MILAN PUNCH BOWL

- 13007038 qt. Bowl only
- 043573Foot only



COFFEE SERVICE

- 13070082-1/2 oz. Creamer
- 13077774-1/2 oz. Creamer



DIAMOND POINT LIGHT

- 1301698Angel Light
Table Lamp

Buffet & Catering



LOUVRE SERVING WARE

- | | |
|--------------------------------------|--------------------------------|
| A. 303492011.....4 oz. Ladle | F. 303492017.....Slotted Spoon |
| B. 303492016.....Serving Spoon | G. 303492014.....9" Meat Fork |
| C. 303492125.....13" Serving Spoon | H. 303492022.....Pastry Server |
| D. 303492126.....13" Serving Spoon | I. 303492414.....Carving Knife |
| E. 303492012.....Solid Spoon 10-1/2" | |

Our collection of elegant, stainless steel serving utensils will enhance your buffet line.

SERVING TONGS

- | |
|-----------------------------------|
| J 555722306" Ice Tongs |
| K. 555722508" Serving Tongs |
| L. 555725308" Serving Tongs |



SUGAR & ICE TONGS

- | |
|--------------------------------|
| 555004214" Sugar Tong |
| 555004226 1/2" Ice Tongs |



SALAD SERVER PASTRY TONG

- | |
|------------------------------------|
| 555004248" Salad/Pastry Tong |
|------------------------------------|



800-877-0087

45



GOURMET LADLE
55500427 1/2 oz. , 5" long



SPOUT LADLE
530886 1 oz. 11" long



SYRUP LADLE
55500429 1 1/2 oz, 7" handle



POT FORK
303492014 9"



PIE SERVER
530884 11"



PASTRY SERVER
530889 11"



COLD MEAT FORK
530870 8 1/2"



BUFFET KNIFE
530875 12 1/2" Wave Cut



BUFFET SLICER
530879 13 1/4" Serrated

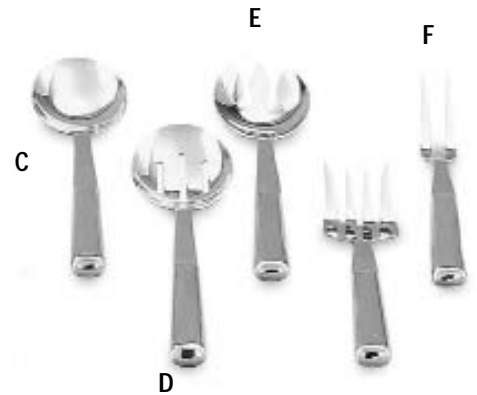

HOLLOW HANDLE BUFFET WARE

Elegantly crafted in one-piece mirror-finish stainless steel with comfortable handles and a well-balanced design.

- A. 530887 2 oz Ladle w/Spout
- B. 530876 4 oz Deep Ladle
- C. 530878 Solid Serving Spoon
- D. 530881 Slotted Serving Spoon
- E. 530882 Notched Serving Spoon
- F. 530880 Buffet Pot Fork



PLASTIC PUNCH LADLE
5051682.....Plastic Punch Ladle



MILAN PUNCH BOWL
Glass bowl and foot from Lancaster
1300703.....Bowl only
0403573.....Foot only



DAISY BUTTON GLASS PUNCH BOWL
11 qt. glass bowl from Libbey. Cups and ladle
are available special order.
12565606..... bowl only



PRINCESS FOUNTAIN BY APEX
This illuminated beverage fountain is made of high-
ly polished stainless steel, with elegant leaf trim.
55540035 gallon



ICE SCULPTURES
Fill mold with water, freeze, and cut open the
mold. Quick and easy, for one-time use. Many
other models available on special order.
50537003Swan Ice Mold
Many other styles available
on special order.



DELUXE FULL SIZE CHAFER

Rectangular. Beautiful European styling with brass plated handles. Stainless steel mirror finish won't rust, tarnish or corrode. Completely assembled with food pan, dripless water pan & fuel holders.
5553441



MAJESTIC RECTANGULAR CHAFER

This full size sculptured chafers with classic traditional styling is at home in any setting. Constructed of 18-8 stainless steel to resist corrosion, complete with food pan, water pan, and fuel holders.
5553440



ROLL-TOP CHAFER

Roll top rotates to either 90° or 180°, accepts standard steam table pans 8 qt capacity. Complete with food pan, water pan, 2 fuel holders, frame & cover.
5553443



DELUXE II ROUND CHAFER

Roll top rotates to either 90° or 180°. Complete with food pan, water pan, fuel holder, frame & cover.
5553444



DELUXE ROUND CHAFER

Beautiful European styling with brass plated handles. Stainless steel mirror polish finish won't rust, tarnish or corrode. Completely assembled with food pan, dripless water pan & fuel holders.
5553442



ECONOMY FULL SIZE CHAFER

Halco's durable economy chafers include strong welded frame, full-size water pan, full-size food pan, dome cover, two fuel holders.

47046844 26-1/4 x 14 x 12-1/4"



LONG ROLL-TOP CHAFER COVER

Add style and convenience to your buffet line. Mirror finish, with brass trim and smooth rolling hinge add to the quality feel. Fits securely without brackets on most full-size chafers that use a standard dripless water pan.

47046052 21-1/8 x 14-7/8 x 9-5/8"



HINGED DOME COVER

This center-hinged dome cover provides one-handed service convenient to your buffet line. Full size.

46010007 21 x 12-7/8 x 2-3/4"



FULL SIZE DOME COVER

46010006

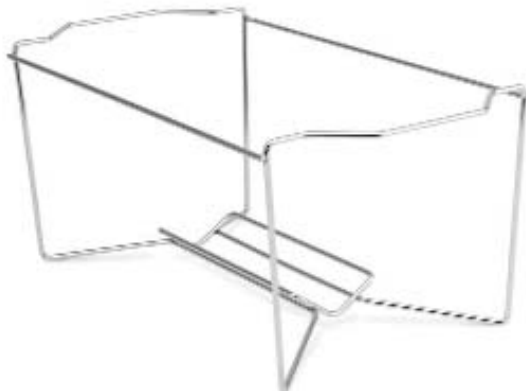

STACKABLE WIRE CHAFER

This heavy duty wire chafers stand is made of 1/4" diameter chrome plated steel. The unique "v" shape fuel holder can fit 1, 2 or 3 fuel holders. Designed to hold one full-size dripless water pan. Use this stand to build your own set from Vollrath equipment.

47046871.....Wire stand only

FUEL HOLDER WITH COVER

Fits most chafers stands

47046864





AMBRIA™
Redesigning Light™



**DISPOSABLE LIQUID WAX
 CARTRIDGE CANDLES**

Virtually orderless, burns bright and clean.
 510141083/4 x 2-1/2", 36 hr.
 510141101-1/2 x 2", 17 hr.
 51012140Tall Cartridge Candles



LONG-BURNING WAX CANDLES

51013104Tea Light
 55505005 hr Wick
 5101210010 hr Warmer
 5101210415 hr Warmer
 5101214412" White Taper
 5101215015" White Taper



LAMP FUEL

Clean burning fuel, burns at a rate of 7 hours per oz with 3/4" flame.



STERNO CHAFER FUEL

5554006 . . .2.625 oz Sterno 144/cs
 5554008 . . .7 oz. Sterno 72/cs
 51012156 . .6 Hour Sterno 24/cs



IWATANI CASSETTE-FEU PORTABLE BUTANE STOVE

The Cassette-Feu 30-FW is designed for reliable outdoor, indoor and commercial use and easy portability. Its heat panel system provides maximum power until the butane can is empty. At 12,000 BTU, the 30-FW produces tremendous power while remaining extremely efficient. Its magnetic locking system also provides greater safety.
13-5/8"W x 12"D x 4"H.

60601051Portable Stove

50563000GM-5 Gas Match

50563001BU-6 Butane Gas Cartridge



PORTABLE BUTANE STOVE

Along with the automatic Piezo-Electric ignition, simmer control and automatic safety device, the E-10SL is designed with a stainless-steel top, brass burner and convenient handles.

E10SL 7,680 BTU (special order)



IWATANI MARBLE TOP INDUCTION STOVE

A safer, more efficient cooking system with instant temperature control like gas but without the discomfort and danger of gas fumes and flames. Fast, clean, safe and more efficient than gas or ordinary electric cooking.

Multiple uses. Ideal for stir-fry, saute, warming, reheating, buffet service, and numerous other uses. Anything you can cook with gas you can cook faster and more efficiently on an Iwatani Induction Range.

Cool to the touch. Induction Ranges are flame-free, fume-free and cool to the touch. This is simply better, more economical, controlled, convenient and reliable than any other comparable cooking technology. Cool electric induction cooking is becoming the preferred cooking method of professionals. 15 x 17-3/8 x 2-3/4", 1800 watts

5555000 Marble Top Induction Stove US-9000



10,000 BTU GOURMET BUTANE STOVE

Cassette-Feu Gourmet Model ZA3 comes equipped with an automatic Piezo-Electric ignition for matchless lighting. It also has a plastic case for easy carrying and storage. An automatic safety device that ensures steady worry-free performance, brass burner and sturdy construction.

60601052 ZA-3 Stove



CAMBRO
DESIGNING THE FUTURE OF FOOD SERVICE

FLOOR MODEL FOOD BARS

Designed to get you in the self-service business profitably, without sacrificing convenience, durability or the stylish appearance of your dining area. Sneeze guards and end panels protect your patrons and thick insulation holds ice for hours. A handy faucet drains melted ice into a pail or attach a hose for added convenience.



<u>Item Number</u>	<u>Overall Exterior Dimensions</u>	<u>Full Size Pan Capacity</u>
4FBR	51" x 33 1/4" x 52 1/2"	3
5FBR	63 1/2" x 33 1/4" x 52 1/2"	4
6FBR	71 1/2" x 33 1/4" x 52 1/2"	5

ULTRA FOOD BARS

Offers the luxury of self-contained storage. The double convenience of quick-access sliding doors on both sides, plus three sizes to choose from, and you have a Food Bar that goes anywhere and does anything. Ultra Bars have food protection with wide sneeze guards and end panel shields, plus rounded edges which serve as a safety feature.



<u>Item Number</u>	<u>Overall Exterior Dimensions</u>	<u>Full Size Pan Capacity</u>
4UBR	51" x 33 1/4" x 52 1/2"	3
5UBR	63 1/2" x 33 1/4" x 52 1/2"	4
6UBR	71 1/2" x 32 3/4" x 52 1/2"	5

All food bars available in the following colors: Black, Slate Blue, Brick red, Coffee Beige, Dark Brown, Cold Blue, Navy Blue, Dusty Rose, Gray, Green, Hot Red, Granite Gray, Granite Green, Granite Red and Granite Sand.



FREE STANDING SNEEZE GUARD

The perfect showcase for dessert items.

FSG480	48"
FSG720	72"

TABLE TOP BUFFET BARS

The Cambro Buffet Bar body design has no seams which means no splitting and no leaking into the insulation. Cambro sneeze guards can be purchased separately to use with any food display. They are color coordinated to match Buffet Bars and your dining decor. Buffet Bars come in 3 and 5 pan models with or without sneeze guards.



<u>Item Number</u>	<u>Description</u>	<u>Overall Exterior Dimensions</u>	<u>Full Size Pan Capacity</u>
BBR480	Buffet Bar w/Sneeze Guard	48" x 24 1/8" x 24 1/2"	3
BBR720	Buffet Bar w/Sneeze Guard	73 7/8" x 24 1/8" x 24 1/2"	5
BUF48	Buffet Bar Base	41 13/16" x 24" x 7"	3
BUF72	Buffet Bar Base	67 1/2" x 24" x 7"	5

Buffet & Catering



ULTRA PAN CARRIER™ FOR 12 x 20" FOOD PANS

The Ultra Pan Carriers retain internal temperature and withstand external tough treatment. Foam insulated and thick lid for durability and heat retention. Nylon latches and air-tight gasket ensure maximum temperature retention. Won't rust. Open and close easily with one hand. Vent cap equalizes internal pressure. Interlock stacking during transport and storage. Easy to carry with molded handles on all four sides. Pans are easy to remove using finger notches. Easy to clean, load and unload.

Item Number	Holds Full Size 12" x 20" or Fractional Size Pans w/Divider Bars
UPC100	3-2 1/2" d., 2-4" d., 1-6" d., or 1-8" deep
UPC140	1-up to 4" deep
UPC160	1-up to 6" deep
UPC180	1-up to 8" deep

CAMBRO
A CAMBRO COMPANY



CAMCARRIERS®

Whatever your food transporting need, there's a Camcarrier built for you! These Camcarriers offer superior heat retention plus versatility with four styles. Their thick foam insulation and air-tight latches and gaskets ensure temperature retention for hours, without any external heat source. Durable construction withstands the toughest treatment. 300MPC accepts ThermoBarriers®, allowing you to store hot and cold food in the same container!

Item Number	Holds 12" x 20" or Fractional Size Pans w/Divider Bars
100MPC	1 - 8" d., 2 - 4" d., or 3 - 2 1/2" deep
100MPCHL	1 - 8" d., 1-6" d., 2 - 4" d., or 3 - 2 1/2" deep
150MPC	1/2 size - 6" d., 4" d., or 2 1/2" deep
200MPC	1 - 4 7/8" d., 2 - 6" d., 3 - 4" d., 4 - 2 1/2" deep
300MPC	2 - 6" d., 3 - 4" d., or 4 - 2 1/2" deep



CAMCART®

These quality made units ensure the delivery of either hot-from-the-oven entrees or cold-from-the-cooler desserts. The tough, one-piece seamless, double-wall, polyethylene construction is easy to maintain and won't dent, crack, rust, chip or break. Thick polyurethane foam insulation and air-tight gaskets help to maintain food quality and temperatures for hours. Full swing doors open 270° to the side for easy loading and unloading. Molded-in handles allow for easy steering and the mold-in bumper minimizes damage to walls and furniture.

Item Number	Holds 12" x 20" or Fractional Size Pans w/Divider Bars
UPC600	45 qt. capacity
UPC800	60 qt capacity
UPC1200	90 qt capacity
UPC1600	12- qt capacity

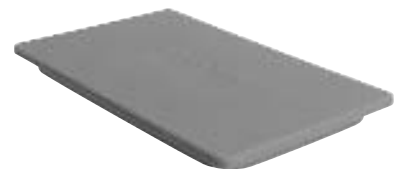

CAMCHILLERS™ & THERMOBARRIERS®

Use a ThermoBarriers® to let you store hot and cold foods in the same cavity; Use a Camchiller® to ensure cold foods stay cold.

CP1220Camchiller
300DIVThermobarrier
400DIVThermobarrier
1600DIVThermobarrier



PORTABLE SNEEZE GUARDS

Designed for food offerings that are set up and taken down on a frequent basis. The High-Profile model should be used when a chafar or ice boat is used. Both are available in 2 to 6 foot models.

- | | |
|-------------------------|-------------------------------|
| 0800.....Folding, 2 ft. | 1630.....HiProfile 2 ft. |
| 0900.....Folding, 3 ft. | 1640.....HiProfile 3 ft. |
| 1000.....Folding, 4 ft. | 1650.....HiProfile 4 ft. |
| 1100.....Folding, 5 ft. | 60614008HiProfile 5 ft. |
| 1200.....Folding, 6 ft. | 1670.....HiProfile 6 ft. |



FOLDING PORTABLE HIGH-PROFILE SNEEZEGUARD SYSTEM

Our goal in developing the Folding Portable SneezeGuard System was to design a unit that is:

- Attractive - Enhances food presentation
- Durable - Retains its usefulness and attractive appearance
- Efficient - Provides for easy transport and storage without damage to equipment
- Labor Saving - Allows server to transport and set up as many as eighteen guards in one trip

These Folding Portable High-Profile SneezeGuards are designed for use over elevated food offerings when a chaffer or ice boat is used. The front of the High-Profile SneezeGuard is 18.5 inches from the top of the counter or table, the same distance as when using the Elevator Set in conjunction with the standard Folding Portable SneezeGuard. Folding Portable Low-Profile SneezeGuards are designed for correct 11" wrist opening situations, such as elementary school serving lines.

The Folding Portable High-Profile SneezeGuards should be used when there is a consistent use over elevated food offerings thereby eliminating the need for installing the elevators on a regular basis. The efficiency and labor saving features of our High-Profile SneezeGuard are maximized when they are used in conjunction with the Storcart for multiple use transport and storage or the Storcase for individual handling. We offer a special extender for our Storcart to handle the taller guards.



Buffet & Catering



CAMBRO SALAD CROCKS

Combining the stylish look of crockery with the durability and convenience of plastic, Cambro's Crocks are the ideal dressing or condiment containers for your salad bar. Smooth, easy-to-clean interior and exterior surfaces are made of FDA accepted material - unaffected by salad oils or mayonnaise. Available in traditional and designer colors, with snap-tight lids for convenient storage.

- 580738011.2 Qt Black Crock
- 580738021.5 Qt Black Crock
- 580738202.7 Qt Beige Crock



CLASSIC™ CROCKS

- * Classic Crock is the original thick-walled heavyweight design
- * NSF listed crocks are made of high-quality SAN
- * excellent chemical resistance to food acids, dressings
- * high-gloss finish is extremely scuff-resistant
- * 0° to 180°F temperature range; dishwasher safe
- * 0300 .6 qt crock fits inside 0301 1.2 qt crock for smaller portions
- * translucent snap-on lids included

- 570308181.2 Quart Red Crock
- 570308191.5 Quart Red Crock
- 570308201.2 Quart Beige Crock
- 570308211.2 Quart Red/Brown Crock
- 570308221.2 Quart White Crock
- 570308242.7 Quart Red/Brown Crock
- 570308252.7 Quart White Crock
- 570308282.7 Quart Crock Insert
- 58026661.2 Quart Crock Lid



CARLY® ONE-OUNCE DRESSING LADLES

- * so tough, they carry a 2-year warranty
- * one-piece polycarbonate construction improves durability and ease of cleaning; dishwasher safe; NSF listed
- * 1 oz, oval-shaped bowl allows pouring of dressings from both sides

- 57030320.....9.5" Red "French"
- 57030321.....9.5" Red "Thousand Island"
- 57030325.....9.5" Black Plain
- 57030327.....9.5" Black "Bleu Cheese"
- 57030328.....9.5" Black "Ranch"
- 57030329.....9.5" Black "French"
- 57030330.....9.5" Black "House"
- 57030331.....9.5" Black "Italian"
- 57030332.....9.5" Black "Thousand Island"
- 57030333.....9.5" Black "Low-Cal"
- 57030334.....9.5" Black Plain

- 57030301.....9.5" Beige Plain
- 57030311.....9.5" Red Plain
- 57030303.....13.5" Beige "Blue Cheese"
- 57030304.....13.5" Beige "Ranch"
- 57030306.....13.5" Beige "House"
- 57030307.....13.5" Beige "Italian"
- 57030308.....13.5" Beige "Thousand Island"
- 57030309.....13.5" Beige "Russian"
- 57030326.....13.5" Black Plain
- 57030302.....13.5" Beige Plain
- 57030322.....13.5" Clear Plain

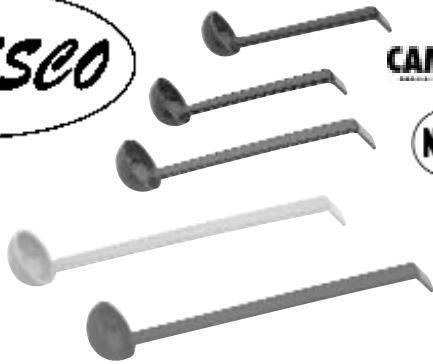

CAMBRO



LADLES

Made of durable polycarbonate making them virtually unbreakable. With portion control bowls to help control food cost. Handles are angled for easy access and controlled grip. Imprinted dressing names are available. 58073960.....3/4 oz. Beige Ladle, 8 1/2" long



Scallop Grip Tongs



Flat Grip Tongs

SALAD TONGS

Available in two styles. The flat grip surface is ribbed for a secure hold. The scallop grip surface is cupped for a firm grasp on salad greens and other hard to hold items. No springs to break. Sanitary and dishwasher safe.

- 58073900.....6" Flat Grip Beige Tong
- 58073910.....9" Flat Grip Beige Tong
- 58073920.....12" Scallop Grip Beige Tong



PASTA FORKS

Tough and lightweight, with perforated bowls for quick draining. Break-resistant polycarbonate is recommended for temps up to 212°F; withstands dry heat up to 270°F.

9-1/2" Buffet Pasta Fork has a sleek design - ideal for salad bars & buffets. Heavy-duty 13-1/2" fork is perfect for back-of-the-house use. Dishwasher safe

- 570302999.5" Black Pasta Fork
- 5703030013.5" Beige Pasta Fork



SALAD BUFFET SPOONS

Provides portion control for salad toppings; dishwasher safe; NSF listed. One-piece, break-resistant polycarbonate is recommended for temps up to 212°F; withstands dry heat up to 270°F

- 570303231/2 oz. 8" Clear
- 570308101/2 oz. 8" Black
- 570303161/2 oz. 8" Beige
- 570308113/4 oz. 10" Black
- 570303123/4 oz. 10" Red
- 570303153/4 oz. 10" Beige
- 570308143/4 oz. 10" Black Perf. Bowl



6"

9"

HIGH HEAT CARLY® TONGS

Made of revolutionary plastic material for unbelievable strength and longevity, can be used on high temperature surfaces like steam tables; withstands heat up to 300°F.

- Dishwasher safe; NSF listed
- 57030812.....6" Black Tong
- 57030313.....6" Red Tongs
- 57030813.....9" Black Tong
- 57030314.....9" Red Tongs
- 57030317.....9" Beige Tong





CAMBRO'S CAMTAINERS

consistently make you look good because your coffee is hot and keeps that fresh brewed flavor. One-piece polyethylene outer shell combined with thick foam core insulates against heat loss for hours. Molded-in mounting plates prevent latches from pulling out. Drip proof recessed spigots allow for clean, easy access. Camtainers are available in 10 different colors for color coding and include a self-adhesive beverage label set.

50502198 500LCD 5 Gallon

6-GALLON BEVERAGE DISPENSER

Perfect for mixing & serving concentrates - pour in the one gallon beverage concentrate, then fill the dispenser to the top with water. You have an instant crowd pleaser - and profit maker! Standard and metric graduations printed on the back of the dispenser for easy mixing and six beverage labels are included for quick identification of contents. Bail and sure-grip handle provide carrying convenience, comes with a drip-proof spigot and handy lid. Durable impact resistant polyethylene is dishwasher safe.

50502195



SLIMLINE BEVERAGE DISPENSER

- * Saves counter space, 7-3/4 x 15-3/4 x 21-1/4"H
- * Hingless cover design
- * FDA approved polypropylene
- * Graduations on side of reservoir

55533010 3 Gallon



PROSERVE™ INSULATED CARRIER

Great as a party tray, pizza box, and insulated food carrier. Holds one 16x18" domed party tray, or two 16" or 18" pizzas. Rigid construction for stacking, lightweight and stylish, its durable gray nylon exterior resists staining and tearing.

5809617 24"L x 23-3/4"W x 10-1/2"D



SOFT VINYL FOOD CARRIER

Lightweight and portable, will hold temperatures for a long time. Must order full case of 6 each.

53029-1/2 x 13-1/2 x 13-1/2"

530111 x 19-1/2 x 13-1/2"



**THE SATURN™ COLLECTION
STAINLESS STEEL SERVERS
BY WALCO.**

- 440936.....12 oz. Teapot
- 440902.....8 oz. Creamer
- 440935.....70 oz. Coffee Server
- 440918.....70 oz. Water Picture



STAINLESS SERVER

12 oz coffee or tea dispenser
with hinged lid.
47046370



**SWIRLSERVE® HOT-N-COLD
BEVERAGE SERVER**

Keep beverages hot or cold for hours with these durable insulated servers. Each server comes with orange, brown and white tabs. Durable polycarbonate inner liner is odorless and stain resistant.

- 4503778.....20 oz White Swirlserve
- 4503780.....42 oz White Swirlserve
- 4503782.....42 oz Decaf



64 oz. STAINLESS COFFEE SERVER

Mirror-finish 18/8 stainless steel, 10 to 12 cup capacity.
555510Black Handle



BLOOMFIELD COFFEE DECANTERS

These durable servers work beautifully with Bloomfield brewers for fast, convenient brewing and coffee serving.

- 4508890.....Unbreakable, plastic & S/S, Regular
- 4508889.....Unbreakable, plastic & S/S, Decaf
- 45089003.....Glass, Regular
- 4508913.....Glass, Decaf

Coffee & Beverage

**60-CUP
VACUUM URN**
44060



2.2 LITRE AIRPOT

Lever/pump airpot with stainless steel body, glass liner and brew-thru system. Works well with Bloomfield Automatic and Pour-Over Airpot Brewers.
4508881 2.2 litre, 72 oz.



MAGNETAGS

Easily identify your brew with these attractive static labels for coffee servers.

- | | |
|-----------------------|-----------------------|
| 5550201.....French | 5550210.....Decaf |
| 5550202.....Irish | 5550211.....Mocha |
| 5550204.....Breakfast | 5550212.....Colombian |
| 5550205.....French | 5550213.....Hot Water |
| 5550206.....Gourmet | 5550214.....Milk |
| 5550207.....Almond | 5550215.....House |
| 5550208.....Amaretto | 5550216.....Blank |



CAMBRO

CAMSERVERS®

Serve it hot, serve it safe and serve it full of flavor. When you add heat to brewed coffee, you lose the flavor! Cambro's CamServer holds serving temperatures for hours with no added heat! So you get great tasting coffee with no hassles involved with canned heating fuels or burned out electrical elements. Plus, you eliminate any safety concerns!

The CamServer solves all of your beverage service problems. And, the attractive design makes a great looking piece anywhere. Available on special order in two convenient sizes, 3 and 5 gallon.

- 3 gal CSR3
- 5 gal CSR5



**AMERICAN CLASSIC™
SERVER**

Foam insulated servers with 2-3 hour heat retention rating. Dishwasher safe. 1 liter, 33.8 oz capacity.
55500218Black
55500219White

**NEW GENERATION™
1 LITER SERVER**

Durable ABS shell, dishwasher safe, Take-apart or brew-thru lids available. 2-3 hour heat retention rating. Available in many colors-ask your RESCO rep.
50500335Copper
55500342Burgundy
55500330Black
55500335Black Lid Burgundy



**THERMO-SERV®
PUSH BUTTON SERVER**

Classic design with safety push-button lid, durable ABS shell, dishwasher safe. 2-3 hour heat retention rating.
555003351.....20 oz. Copper/Black
505003361 Liter Copper/Black
505003361.....2 Liter Copper/Black

**THERMO-SERV®
FLIP-TOP SERVER**

Classic design with safety push-button lid, durable ABS shell, dishwasher safe. 2-3 hour heat retention rating.
555003381 Liter, White



16 OZ TEAPOT

Durable plastic teapot with double-wall insulation, with a 2-3 hour heat retention rating. Dishwasher safe.
55500328Black
55500345Black Lid

**ECO-SERV™
PLASTIC SERVER**

Fluted design with snap-on decaf indicator, durable ABS shell, dishwasher safe. 2-3 hour heat retention rating. 1.3 liter (44 oz)
55500364White
55500366Black



**SECA
VACUUM AIRPOTS**

Stainless steel exterior with unbreakable liner. Hand wash. 8-8 hour heat retention rating
5550033774 oz S/S Black
555003371 ...101 oz S/S Black

**PUSH N' SERV
VACUUM SERVERS**

Stainless steel exterior with ergonomically friendly push button. Glass liner with vacuum insulation. Hand wash. 8 hour heat retention rating.
555003372 ...1 liter S/S Black
555003373 ...1.6 liter S/S Black



STEELVAC™ CARAFE

Stainless steel exterior & interior. Unbreakable liner, with brew-thru lid.
555003374 SW-100 1 Liter White
555003375 SB-100 1 Liter Black
555003376 SS-100 1 Liter S/S





55 Cups



30 Cups



101 Cups

REGALWARE COFFEE PERCOLATORS

- 5551310010 - 30 Cups 1090 watts
- 5551310412 - 55 Cups 1500 watts
- 5551310812 - 101 Cups 1500 watts

Polished aluminum percolators brew perfect coffee and automatically hold it at the ideal serving temperature. These percolators are built for heavy duty service, and feature non-drip faucet, stay-cool phenolic handles and knob, 3-prong grounded plug w/cord, and signal light that indicates when coffee is brewed. 110-120 V.



FARBERWARE® COFFEE URN

- * Durable mirror-finish stainless steel
 - * Coffee-ready indicator light
 - * Automatically switches to "Keeps Warm" temperature
 - * Elegant side handles
 - * Non-drip spigot
 - * Stay-cool base
 - * Dishwasher safe brewing basket
- 12-55 Cup Coffee Urn FSU255

Hamilton Beach
COMMERCIAL



HAMILTON BEACH 4-CUP COFFEE MAKER

Euro-Styling offers a compact, space-saving design in an easy-to-use coffeemaker. 1- Hour Automatic Shutoff for safety and convenience. Auto Pause 'N Serve allows the guest to sneak a cup before brew cycle is complete. Operating Instructions printed on top for easy reference. Nonstick Keep-Hot Plate easily cleaned with the wipe of a sponge. Illuminated On/Off Light, know at a glance if unit is on. Complete with 4' Cord and glass carafe.
55540101D40101 HB Coffee



THERMAL DISPENSERS

Bloomfield airpots and thermal dispensers make it easier to serve hot or cold beverages wherever they're needed, at the perfect temperature.

- * Brew directly into dispensers
- * With sight glass
- * Capacities up to 84 oz./2.5 liters
- * Glass vacuum insulation
- * Fold-down handles

4507750Regular w/Base



STEP-UP

COFFEE WARMER

- * All stainless steel construction
- * Fits on counter tops and under cabinets
- * Individual lighted power switches
- * 1-piece porcelain enameled warmer plates

45085532-Warmers



KOFFEE-KING LO-PROFILE POUR-OVER AUTOMATIC BREWERS

Bloomfield Brewers are built to last, with all stainless steel construction, one-piece drawn stainless steel water tanks, heavy duty lighted warmer switches and easy access to all internal controls. Each has an exclusive water spreader disc that gently and completely saturates the coffee for maximum flavor, and features that make operation safe and easy.

- * Less than 17" high, 14" deep
- * Fits on counter tops and under cabinets
- * Ready to brew light

45085723-Warmer w/Faucet



THREE-WARMER AUTOMATIC BREWER

Pour-over option, faucet,
1800W, 120V, 15 amp.
21" D x 8 5/8" W x 18 7/8"H
4501012



BLOOMFIELD E-MAX TEA BREWER

Precise Temperature Brewing maintains a safe consistent temperature. Advanced LCD display allows quick visual access to all tea brewing functions. Brew tank capacity of more than 2 gallons meets demand at peak times. Faucet for use with both 3 & 5 gal. dispensers. Programmed by-pass valve allows varying flow rate for different teas and weights.
2030.....21-1/2"D x 11"W x 35"H



Cecilware Corporation



CAPPUCCINO DISPENSERS

These models utilize the most reliable components currently available, and are designed to service low to medium volume requirement locations using minimum counter space. The 3K-GB-LD has the smallest footprints of any 3 hopper dispenser.

1K-GB-LD 1 Flavor, 1.6 Gal, 8 1/2"W x 31"H

3K-GB-LD 3 Flavor, 3 Gal, 10"W x 31"H

HOT CHOCOLATE DISPENSERS

Cecilware has redefined and perfected its hot chocolate dispensers to suit all your requirements. By incorporating state-of-the-art technology, Whipping Chambers, Direct Drive Gear Systems and Vacuum Steam Removal Systems, you can insure your customers delicious, creamy hot chocolate. 8 lb hopper capacity; 16" W x 24"H

4914 Manual

4914-AT Automatic



Cornelius



ONE-FLAVOR JET SPRAY JUICE DISPENSER

- * 5 Gal Visual Display Dispenser
- * Built-in product protection to inhibit bacterial, mold and fungal growth on plastics that cause odors and stains
- * Voltages: 115/60Hz, 240/50Hz
- * Width: 7-3/4"
- * Height: 26 5/8"
- * Depth: 17"

JT7 Cornelius

TWO-FLAVOR JET SPRAY JUICE DISPENSER

- * Visual Display Dispenser with Separate 5 Gal Bowls on Single Base
- * Built-in product protection to inhibit bacterial, mold and fungal growth on plastics that cause odors and stains
- * Voltages: 115/60Hz, 240/50Hz
- * Width: 16"
- * Height: 26 5/8"
- * Depth: 17"

JT20 Cornelius



FLUID MEASURES

.....	1/2 fl oz =	1 tbsp =	3 tsp
.....	1/8 cup	1 fl oz	2 tbsp
.....	1/4 cup	2 fl oz	4 tbsp
.....	1/2 cup	4 fl oz	8 tbsp
.....	1/4 qt	1/2 pt	1 cup
.....	1/2 qt	1 pt	2 cups
1/4 gal	1 qt	2 pt	4 cups
1/2 gal	2 qt	4 pt	8 cups
1 gal	4 qt	8 pt	16 cups

METRIC CONVERSIONS

1 fluid ounce.....1.0408 UK fl oz.....29.574 ml
 1 pint (16 fl oz)0.8327 UK pt.....0.4731 l
 1 gallon (gal).....0.8327 UK gal.....3.7854 l

1 milligram [mg].....0.0154 grain.....0.001 gram
 1 centigram (cg).....0.1543 grain.....0.01 gram
 1 grain.....64.799 mg
 1 gram [g].....1,000 mg.....0.0353 oz
 1 kilogram [kg].....1,000 g.....2.2046 lb
 1 ton [t].....1,000 kg.....0.9842 ton

1 ounce [oz].....437.5 grain.....28.35 g
 1 pound [lb].....16 oz.....453.6 g
 1 stone.....14 lb.....6.3503 kg
 1 hundredweight [cwt].....112 lb.....50.802 kg
 1 ton (short).....2000 lb.....0.907 metric ton

1 millimetre [mm].....0.03937 in
 1 centimetre [cm].....10 mm.....0.3937 in
 1 metre [m].....100 cm.....1.0936 yd
 1 meter (m).....39.37 in
 1 kilometre [km].....1000 m.....0.6214 mile

1 inch [in].....2.54 cm
 1 foot [ft].....12 in.....0.3048 m
 1 yard [yd].....3 ft.....0.9144 m
 1 fathom.....6 ft
 1 rod.....16.5 ft.....5.5 yd
 1 furlong.....40 rods.....220 yd
 1 mile.....1760 yd.....1.6093 km
 1 mile.....5280 ft
 1 int. nautical mile.....2025.4 yd.....1.853 km
 1 int. nautical mile.....6076.2 ft

BAR SERVICE GUIDE FOR 100 PEOPLE

BAR SERVICE	Hotels/ Cocktail Lounges	Restaurants	Caterers
Champagnes (4½-6 oz)	3 Dozen	3 Dozen	9 Dozen
Cocktails (2½-5 oz)	9 Dozen	6 Dozen	12 Dozen
Wines (all purpose)	6 Dozen	6 Dozen	9 Dozen
White Wines (6½-9 oz)	3 Dozen	—	—
Red Wines (6½-16 oz)	3 Dozen	—	—
Sherries (2-4½ oz)	3 Dozen	—	9 Dozen
Whiskey Sours	3 Dozen	—	—
Brandy/Cordials (¾-20 oz)	3 Dozen	—	6 Dozen
Whiskey/Shot Glass (¾-3 oz)	3 Dozen	3 Dozen	—
Old Fashioned Glass	9 Dozen	6 Dozen	12 Dozen
On-The-Rocks (6-9 oz)	9 Dozen	6 Dozen	12 Dozen
Collins (9-12 oz)	3 Dozen	3 Dozen	—
Hi-Balls (7-10 oz)	9 Dozen	6 Dozen	12 Dozen
Beer Servers	3 Dozen	6 Dozen	—
Decanters (2½-6 oz)	3 Dozen	3 Dozen	—
Water Pitchers (8-24 oz)	1 Dozen	—	6 each
Stirrers	1-5M	1-5M	10M
Champagne Buckets & Stands	4 each	2 each	10 each
Ice Buckets	6-12	6	10
Liquor Pourers	3-6 Dozen	2-4 Dozen	—

BAR SERVICE	Hotels/ Cocktail Lounges	Restaurants	Caterers
Bar Mixers	2	1	6
Fountain Scoop	2	1	1
Cocktail Shakers	6	3	6
Jiggers (½-2 oz)	2-3	1-2	4
Lemon Boards	2	1	1
Sponges	1 Dozen	6	6
Lemon Peeler	1	1	1
Bar Strainer	2-3	1	2
Ice Pick	2	1	2
Twist Spoon	6	2	2
Muddler	2	1	—
Towel Holder	3	1	—
Bar Caddies	3	1	2
Corkscrews	4-6	2	10
Fruit Knife	3	1	2
PAPER SERVICE			
Coasters	50M	25M	100M
Beverage Napkins	50M	25M	100M
Picks	10M	5M	—
Cocktail Straws	5M	2M	—



**GENESIS™
WAITER'S CORKSCREW**

Floating axis design relieves stress so the boot lever "hugs" against the cork during extraction. Includes a two-tempered wheel foil capsule cutter, instead of a knife blade. 5-1/8" long.
55502032

FRANMARA



**AHH SUPER™ TWO-PRONG
CORK EXTRACTOR**

Best value in a 2-prong cork extractor on the market. This type made popular by California wineries. Equipped with protective ABS sheath. Tempered prongs. 4-3/8" overall.
55502125



**CAPITANO™ WAITER'S
CORKSCREW**

Extra long handle for increased leverage. New elongated spiral for long corks; nickel plated boot lever, nickel plated serrated knife, and nickel plated spiral; 5-3/8" long
55502015 Burgundy



WAITER'S CORKSCREW

Three-in-one accessory for all waiters, bartenders, etc. With curved knife blade.
55502020

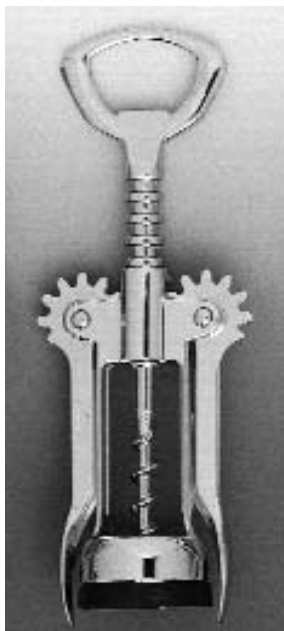

WING CORKSCREW

Strong twist-in, press-down wings designed for swift removal. Includes can opener, new flange bottle base. 6-5/8" long.
55502040



**CAN TAPPERS
& BOTTLE OPENERS**

Nickel plated steel. Opens cans, as well as all bottle caps
54060090 4" long
55590510 6-3/4" long



BAR STRAINERS

For mixed drink perfection. All stainless steel, will not discolor.
 55500412Two Prong
 55500413Four Prong



S/S MALT CUP

Highly polished stainless steel, with gradations. Fits standard malt machines
 55500403.....32 oz.



COCKTAIL SHAKER

Stainless steel cup, polished to a mirror finish.
 4501728 oz.



3-PC COCKTAIL SHAKER

With shaker, strainer & jigger all in one unit. Stainless steel..
 5550040928 oz.



ICE PICKS

Hardened steel points, wood handles, commercial quality.
 53010411.....8 3/8"
 IC-80.....8 5/8" w/ice breaker handle
 IC-78.....9 1/4" w/6 hardened tips



DELUXE BAR MAT

Brown mat measures
 3-1/4" x 23-3/4" long
 530918



SERVICE MAT

One-piece rubber.
 530919 12x18"

STAINLESS TWISTED BAR SPOON

The proper tool for mixing cocktails. Polished stainless steel with red knob. Even-twisted shanks for appearance and durability.
 5550040010"
 5550040211"



LEMON-LIME SQUEEZER

Stainless steel for heavy duty professional use. Will not rust, tarnish or corrode. Easy to clean. With strainer.
 55500410



COPPER MULE MUG

With these highly polished, solid copper mugs. Drinks stay cold longer in a copper mug. With "Mule" inscription.
 5550040712 oz



STRAINER FUNNEL

Spun aluminum with built-in strainer, makes disposal of accumulated debris possible. Fits standard overflow pipes.
 524ST1 pint capacity

OVERFLOW PIPES

Plastic pipes set in rubber bushings to fit 1" and 1-1/2" drains.
 9131338....7" overflow pipe, for 1" to 1-1/8"drains
 9131339....11" overflow pipe, for 1-1/2" drains





FRUIT CUTTING BOARD

One inch thick hardwood,
smooth on both sides
555691 6 x 9"



CONDIMENT DISPENSERS

Convenient, hygienic storage for condiments & garnishes.

5802890.....6-Compartment Condiment Dispenser

5802891.....3-Compartment Condiment Dispenser

5802892.....Pint Insert

5802893.....Quart Insert

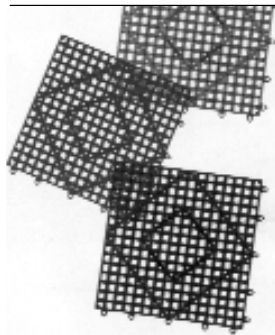

VERSA-MAT™

Interlocking bar matting that can be used in most locations. raised support structure provides maximum airflow for drying, while eliminating barware contact with unsanitary surfaces.

VM5280BB ...12x12" Blue

VM5280CL....12x12" Clear

VM5280RD ...12x12" Red

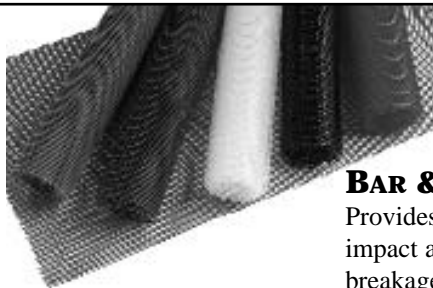

BAR & SHELF LINER

Provides skid resistance and impact absorption to reduce breakage. 24 in x 4 ft roll.

5051680 Clear



MARBLE WINE CHILLERS

Makes serving wine neat and easy. Pre-chill the genuine marble chiller and keep chilled wine at proper serving temperature for 60 minutes. No dripping ice buckets.

Customers pour wine when they want to, increasing wine usage. A decorative, profitable addition to any table setting.
55501872



MULTIPURPOSE KNIFE

Serrated 5.1" long paring knife
for all cutting jobs.

53010509



FUNNELS

47084770 ...1 qt. S/S

53093516 oz. Plastic



MARGARITA GLASS RIMMER

The best and fastest way to salt the rim of a glass.

555100 ...Rimmer complete

555150 ...Sponge replacement

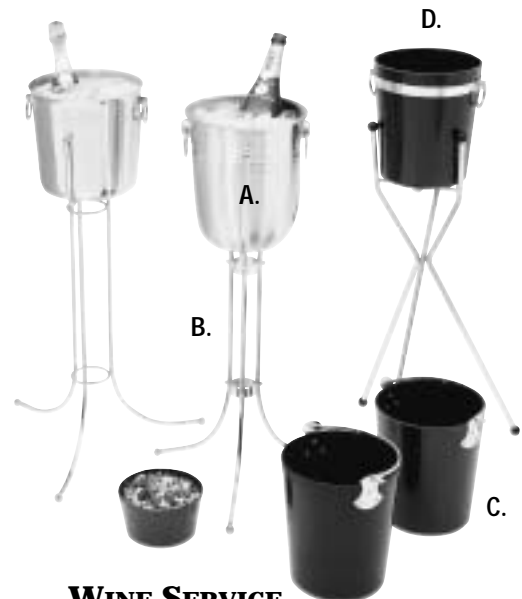

WINE SERVICE

Present wines and champagne to your patron's table in these attractive and practical wine buckets and coolers with stands.

A. 45079501.....S/S Wine Bucket Only

B. 45079502.....Wine Bucket/Stand Set

C. 47052930.....Wine Cooler

D. 47052932.....Champagne Bucket



CARLISLE
FoodService Products

CARLISLE STORE 'N POUR SYSTEM

Your business will enjoy the benefits of the most efficient storing and pouring system for the bar, kitchen or dining room.

- | | |
|------------------------------------|-------------------------------|
| 57030950Quart Complete | 57030956Quart Jar Only |
| 57030951Half Gallon Complete | 57030961Orange Spout |
| 57030960Red Spout | 57030963Green Spout |
| 57030962Yellow Spout | 57030966Red Cap |
| 57030964Clear Spout | 57030968Green Cap |
| 57030967Orange Cap | 57030970Brown Cap |
| 57030969White Cap | 57030954Repl. Neck Only |
| 57030971Yellow Cap | |



PORTION CONTROL LIQUOR DISPENSERS

Control your bar profits by dispensing exact shots quickly and easily.

- 555045103/4 oz. Green
- 555045301 oz. Red



JIGGERS

Polished on the outside with satin finish inside, stamped with oz. capacity. Special order, from 1/2 oz. to 1-1/4 oz..



MUDDLERS

Hardwood, perfect for crushing fruit, condiments, etc.

- M888.....8" long
- M1010.....10" long



FREE FLOWING LIQUOR DISPENSERS

Bright colored plastic for free-flow pouring.

- 555301.....Red
- 555302.....Mint Green
- 555303Sparkle Green
- 555304.....Sparkle Red



GLASS JIGGER

3 oz tempered glass
12502303



LIQ-TROL® POURER

This adjustable measured liquor dispenser has adjustable disks inside to control the amount of the measured pour.

- 55525100Liqua-Trol Liquor Pourer
- 55525102Bottom Only
- 55525101Rebuilt Liq-Trol Dispenser for exchange only



CHROME JET POURER

Medium fast speed pourer. Gooseneck spout for extra smooth controlled pouring.
555235 Poly cork



CORK LINED TRAYS

Reduce spillage and breakage with these sturdy, cork lined, laminated serving trays. Prevents slipping - even when wet. Molded cork liner will not peel or warp.

4703103512x16" Rect. Cork Tray	4703104523x28" Oval Cork Tray
4703103714x18" Rect. Cork Tray	4703104711" Round Tray
4703103915x20" Rect. Cork Tray	4703104914" Round Tray
4703104320x25" Oval Cork Tray	4703105116" Round Tray



TIP TRAYS & MONEY MAID TRAYS

Make that final impression with these time-saving and attractive trays.

470310204x6" Brown	
470310245x7" Brown Tip Tray	
50506000Money Maid	for Rect. Tray
50506001Money Maid	for 14" Round Tray



GRIP TITE™ TRAYS

Reinforced trays with permanently bonded rubber liner prevents slipping and sliding of glass and dinnerware.

5703074614" Round Beige
5703074716" Round Beige
5703074824-1/4 x 26-7/8" Oval Beige



BAR DRAIN TRAY

A full-width drain tray for the bar sink. The large, flat surface helps eliminate screen blockage. Made from polystyrene, and comes with a drain tube.

CR760.....14"L x 5"W x 3"D



ONE GALLON FOOD BLENDER

- Heavy duty 3.75 hp motor
 - Easy-to-clean electronic membrane panel with 3-speeds & pulse
 - S/S container w/2 handles
 - Clear see-thru lid
 - Slow start feature
 - New dishwasher-safe 1-piece jar pad for easy cleaning
 - 120 VAC, 50/100 Hz
 - Limited 3-year motor warranty
 - UL, NSF, CUL
- 60601093Waring CB15



60601089

WARING BAR BLENDERS

Dependable, two-speed motors and simplicity of operation put more specialty drinks and classic cocktails into production. Rugged, one-piece stainless steel cutting blade. Exclusive metal-reinforced rubber drive coupling is easily replaced on-site Die-cast zinc base epoxy powder coated. Available with either 32 oz. stainless steel container, or clear 48 oz. unbreakable polycarbonate container with user-friendly lid. 120VAC, 50/60 Hz
 60601089 BB150 Bar Blender w/Clear Container
 60601090 BB150S Bar Blender w/SS Container

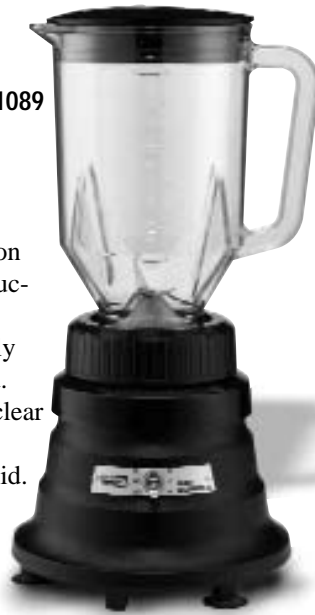

60601090



**MARGARITA MADNESS®
 BAR BLENDER BY WARING**

Blend a high-profit batch of Margaritas & Daiquiris in as little as 5 seconds! Waring's high-powered, high speed Margarita Madness® Bar Blenders prepare today's favorite drinks with fast, high-demand results. Metal-reinforced drive couplings can be replaced on-site without a service call, for an extra measure of user convenience. Heavy-duty 1 HP two-speed commercial motor. Exclusive, heavy-duty, one-piece stainless steel cutting blade. 48 oz. clear, unbreakable polycarbonate container. Metal-reinforced rubber drive coupling is easily replaced on-site; 120VAC, 50/60 Hz.
 60601091 MMB142



**SELF-TIMER
 TWO-SPEED BLENDER
 BY WARING**

Increase efficiency with this self-timing blender, with self timer, 3 seconds, 15 seconds or manual settings.
 60601094 7015N

WARING

WARING HALF GALLON BAR BLENDERS

Heavy-duty, two-speed, 1 HP commercial motor. Sturdy die-cast base with 64 oz. stainless steel or 48 oz. clear, unbreakable polycarbonate containers. Easy to replace drive coupling on-site. 120 VAC,50/60 Hz
 60601087w/Clear Container BB185
 60601084w/S/S Container HGB150



60601087



60601084



**HALF GALLON
BAR MIXER**

This high power/low energy consumption half-gallon unit is designed to meet professional demands. Two speed versatility with pulse option creates precise blending every time. 4 stainless steel cutting and mixing blades ensure perfectly smooth drinks with no unwanted ice or fruit chunks. With a break and stain resistant 1/2 gallon polycarbonate container with easy-to-read graduated measurement marks and superior vortex action. 1/2 hp, 120 Volts, 60 Hz.
91200 Bar Blender



BAR BLENDERS

The perfect choice for smoothies, margaritas, daiquiris, iced cappuccinos, granitas, and more. Considered the worldwide standard by bartenders who've come to rely on their dependable performance. Separate "On/Off" and two speed toggle switches located for quick and easy access. 4 stainless steel cutting / mixing blades ensure perfectly smooth drinks with no unwanted ice or fruit chunks. With a break-resistant 44 ounce polycarbonate container, or a 32 ounce stainless steel container. 1/4 Hp., 120 Volts, 60 Hz.
60601048908/ Clear Container
60601049909/ S/S Container



TEMPEST BLENDER

High torque 2+ hp motor for efficient, quieter operation. Three programmable cycles give you sets of pulses and speeds for precision blending. Rotary dial timer lets you vary the blending time for each cycle. High-Performance stainless steel cutting and mixing blades ensure smooth drinks without unwanted ice or fruit chunks. Electronic speed control with load sensor provides constant speed regardless of the load. With a 32 oz. Lexan® container, vinyl lid with filler-cap.
91555 Tempest Blender

For a wider selection of mixers and blenders, please see the Equipment Chapter.



1 & 3 SPINDLE DRINK MIXER

Perfect for milk shakes, smoothies, bar cocktails, eggs, batters, ice cream drinks, and more. Bartenders worldwide consider this drink mixer the standard because of its dependable performance. The three speed toggle switch is conveniently located for quick and easy access. Designed for durability, the stainless steel agitator crushes ice and cuts through hard ice cream. The motor automatically activates when the cup is placed in position on the drink mixer, and stops when the cup is removed. The automatic motor activation ensures perfect operation every time. 1/6 Hp. 120 Volts, 60 Hz.
555936.....1-Spindle Drink Mixer
555009503-Spindle Drink Mixer





TWO-STEP DRINK MACHINE

Put away that old granita machine; toss that slow moving blender; free up time for your servers to serve! Vita-Mix® makes it possible to blend the perfect granita, frozen coffee and tea, smoothie or margarita - all with the same machine. With a 2+ peak hp motor with 37,000 rpm motor speed, all stainless steel enclosed blade assembly with sealed ball bearings. Specially designed clear polycarbonate container is virtually unbreakable and lets you see inside. Blends as little as 4 oz. with the same consistency and quality as a full load. Now you can put ingredients in the blender, set the timer and walk away. The blender stops automatically!

6061230.....1230 Vita-Mix 2-Step Blender



BAR SINKS

Shown is our Challenger Model 21" deep, 3-compartment sink, with deck-mount faucet, overflow pipes, stainless steel drains and molded apron for extra durability. Let us know your needs, and we'll help you find the right bar sink. Please check Equipment Chapter for more sinks.

606110233-compartment sink, 59" long, with drainboards left & right



GLASS WASHING BRUSHES

- Positive-suction molded plastic base provides a tight grip in sinks and countertops
- All plastic construction helps prevent glasses from being chipped or broken and seals out moisture
- Cleans most bar glasses

80890.....8" Twin Glass Washer

80895.....8" Triple Glass Washer



BAR MAID GLASS WASHERS CONSTANTLY DELIVER!

- Easily installs in virtually any sink in seconds
- 5 spinning brushes for crystal clear glasses - faster
- Built with the heaviest quality components available
- Tested and approved to toughest UL, CSA and NSF standards
- Service and reliability that's tough to beat

60601016A-200 Upright Bar Glass Washer

60601017SS-100 Submersible Glass Washer

808901.....Replacement Brush ea.

8080226.....Glasswashing Detergent 6/1 gal.



CAMWEAR PITCHERS

Are these glass pitchers? Of course not, they are made of polycarbonate, the best alternative to glass. They won't chip or break. Polycarbonate construction assures long life, eliminates replacement costs and provides light-weight, easier handling for servers. Thumb-grip pour control and exclusive ice-control contoured lip and pour spout eliminate the mess associated with other pitchers. Camwear Pitchers are dishwasher safe and available in 5 styles and a variety of sizes. Slotted base helps drain water for complete and sanitary drying. Exclusive ice lip lets you control amount of ice with beverage. Broad base for stability, prevents tipping.

580333548 oz. Clear P480CW

580333860 oz. Clear P600CW

580338160 oz. Amber P600CW



RUBBERMAID BOUNCER PITCHERS

The clarity of glass with the safety and durability of polycarbonate.

- Resists chipping and breaking.
- Commercial dishwasher safe.
- Drip-proof spouts.
- Certified to NSF Std. #2.

580333754 oz. Clear Bouncer

580333972 oz. Clear Bouncer



CAMLITERS

Wine decanters make a distinctive presentation at any table or buffet line. But glass is so impractical. It chips and breaks causing lost product or worse... an injury. Cambro has solved all of that by making these decanters out of polycarbonate. They won't chip or break. Also, they help save time. A spill-proof lid is included. Perfect for serving juice on a buffet, at a table or for room service. It allows you to fill and store beverages in off hours.

505021491 Liter

606932



44023



MANUAL JUICERS

Designed to extract pure citrus juice from oranges, lemons, limes and grapefruits. Acid-resistant finish, rack and pinion gearing, easy operation, and sure-grip feet.

606932Hamilton Beach 932

44023JE23 Heavy Duty



ALUMINUM SCOOPS

Made of die-cast aluminum, highly polished inside and out.

- 530103985 oz.
- 5301039912 oz.
- 5301040024 oz.
- 5301040138 oz.
- 5301040258 oz.
- 5301040385 oz.



RUBBERMAID BOUNCER SCOOPS

Multi-purpose Carb-x® and Dur-XT™ designed for better weight distribution and better handling.

- 58028826 oz. Bar Ice 2882 Clear
- 580288432 oz Bouncer 2884 Clear
- 580288564 oz. Utility Scoop 2885 White
- 580288664 oz. Utility Scoop 2886 Clear



STAINLESS STEEL ICE SCOOP

This narrow-nose scoop is perfect for the bar, ideal for ice, flour, condiments. 1/2 cup capacity, 9" long.

4503912



SUPER SCOOP

Durable white plastic, 64 oz.
555830



STAINLESS ICE BIN SCOOP

Stainless steel with a sturdy round handle.
4709211052 oz



PLASTIC ICE BIN SCOOP

One-piece durable, white plastic, with a flat bottom. Dishwasher safe and non-toxic.
530183382 oz



PLASTIC SPEED RAIL

Kwik store single tier injection molded speed rail with hanging straps or in keyhole style.
6061103623"



STAINLESS STEEL SPEED RAILS

Heavy-gauge stainless steel rack keeps bottles where you need them in a hurry.
6061103722"
6061103824"

Bar Supplies



BRASS GLASS HANGER

Genuine heavy-gauge brass wire, has an entry and stop section so glass won't fall out.
 5551001616"
 5551002424"



BAR TOWELS

Good quality, absorbent cotton bar towels, sold by the dozen.
 80811413Ribbed White
 80811416Red Stripe



NAPKIN HOLDER, STIRRERS & PICKS

Designed with a pedestal base to fit securely into the drain rail. With side pockets for stirrers and picks.
 CR1272 . . .Napkin Holder
 50546003 . . .Aero Picks
 50546001 . . .Sword Picks
 50501102 . . .8" Bar Straws
 50501100 . . .5-1/2" Sip-Stix



UMBRELLA PICKS

Assorted colors
 50546010

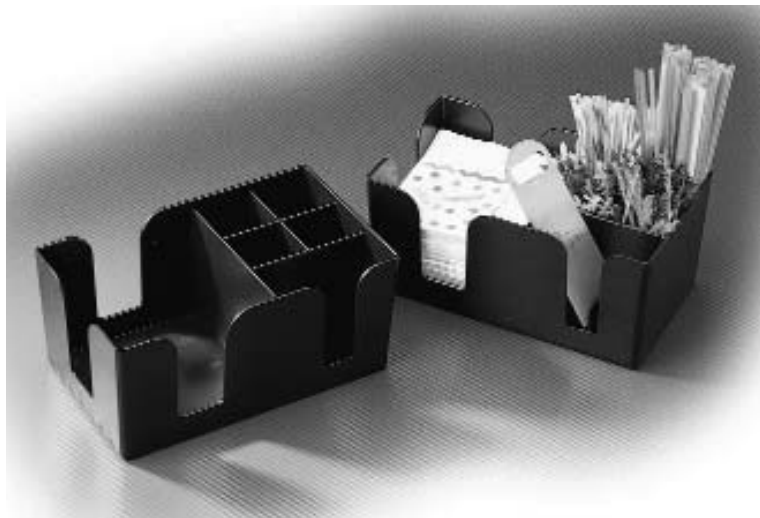

BAR CADDY

Black ABS plastic caddy has 6 compartments for napkins, straws, picks and utensils.
 5050101

BAR MIXES & CONDIMENTS

RESCO carries a full selection of fresh condiments and mixes for a huge variety of drinks.

- 52010100.....Roses Lime Juice
- 52010200.....Cherries 4/1 Gallon (no stem)
- 52010250.....Cherries 4/1 Gallon (with stem)
- 52010350.....Olives 4/1 Gallon
- 52010400.....Onions 12/16 oz.
- 52010500.....Margarita Salt 12/8 oz.
- 52020340.....Mr. C's Margarita 12/32 oz.
- 52020350.....Watt's Clamato (12/32 oz.)
- 52020375.....Strawberry Daiquiri 12/32 oz.
- 52020380.....Mr. C's Triple Sec 12/LT
- 52020390.....Mr. C's Grenadine 12/LT





LIQUOR DISPENSING SYSTEMS
RESCO can help you keep your liquor operations
legal and profitable with a Liquor Dispensing
System, approved by the State of Utah

WUNDER-BAR® DISPENSING SYSTEM

Let us design and install a Wunder-Bar behind your bar, so you will have the "big guns" in liquor dispensing on your team!

With Wunder-Bar, the service flows. drinks are served accurately, consistently, and faster than ever before. The bartender holds as many as 16 different liquor brands in the palm of his hand, ready to pour a pre-measured amount in less than 1.5 seconds! Concerned about state-mandated requirements? No problem! Push the brand selection, and the system will automatically pour an accurate amount, pre-set to your desire. What about control? No problem! Each time a drink is poured or a drink size is varied, it is recorded, by shift and station, and made part of the system's beverage management report - which you may examine, anytime.

CONTROL & RECORD KEEPING

The beverage manager has full access to the information that is needed to manage the bar efficiently and effectively. This information is available daily, weekly, monthly.



Keep accurate daily track of your liquor records.



FIXED POINT CONSOLE

The underbar mount dispenser is offered for fixed-point dispensing.



BAR-GUN

Fixed hose faucets provide quick and easy access to as many as 16 brands of liquor on one dispenser.



STORAGE RACKS IN 4 SIZES

Bar management requires quick and easy access to accurate pour information. You'll receive timely and accurate reports that allow you to better calculate your pouring costs - and comply with state regulations. Your inventory will be easier to figure than ever before - more reliable too. Switching from 1 liter to 1.75 liter bottles will simplify storage, accounting and ordering.

Wunder-Bar's on-staff Electronic Engineers and microprocessor design allow for easy interfacing to a wide variety of point-of-sale systems and electronic cash registers. These optional features can be designed for your bar operation, or we offer programs that have been designed for other successful bar operations.

Call your RESCO representative to discuss a system that will meet your needs and increase your profits.

Wunder-Bar

POLISHED CAST ALUMINUM TRAYS BY BALAAM INTERNATIONAL

These economical cast aluminum trays are hand polished and will not tarnish. For best results prechill or preheat to keep food warm or cold for hours. Hand wash with mild soap and dry immediately. Prime trays with light oil prior to use when fatty acids may be present.

- A. 40429712x6" deep Plain Salad
- B. 40429928x10" Kayak
- C. 40430023x17-1/2" Buffet
- D. 40430914-1/2" Round Aurora Bowl
- E. 40431118" Round Pasta Bowl
- F. 40431625" Round Centerpiece
- G. 40431711" Square Dish
- H. 40431915" Round Plain Platter

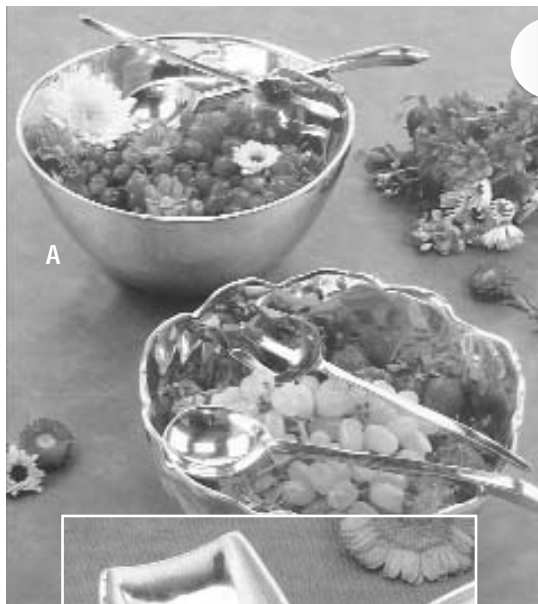

A

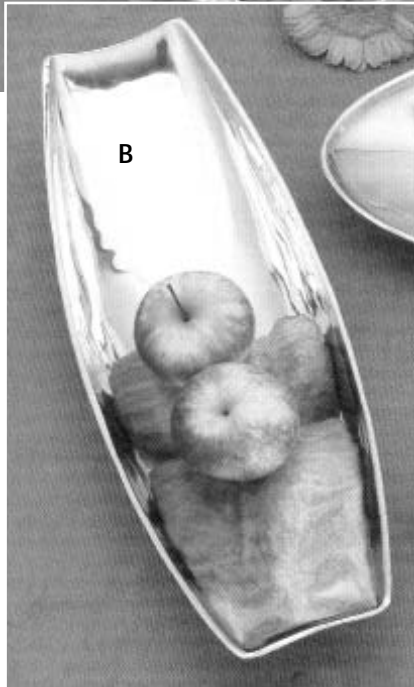

B



D



E

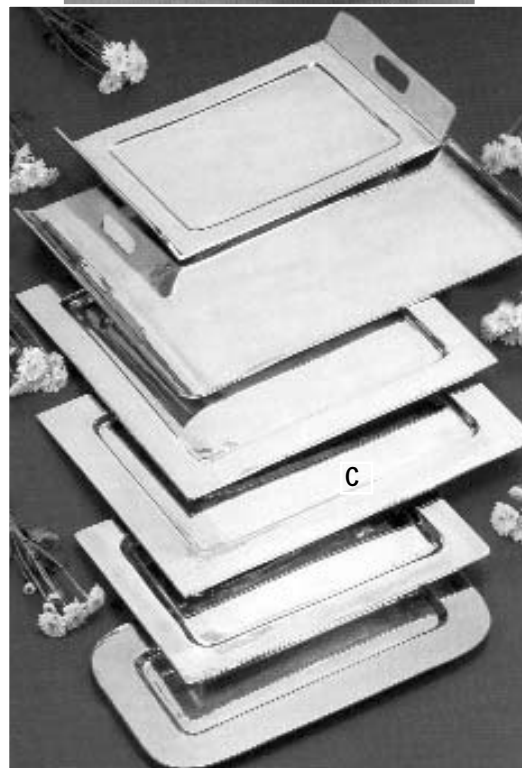

C



F



G



H

Ask your RESCO representative about the large variety of special order Polished Aluminum Trays & Bowls that are available.



CRYSTALWARE TRAYS & BOWLS

- Beautiful, high impact styrene
- Durable & dishwasher safe

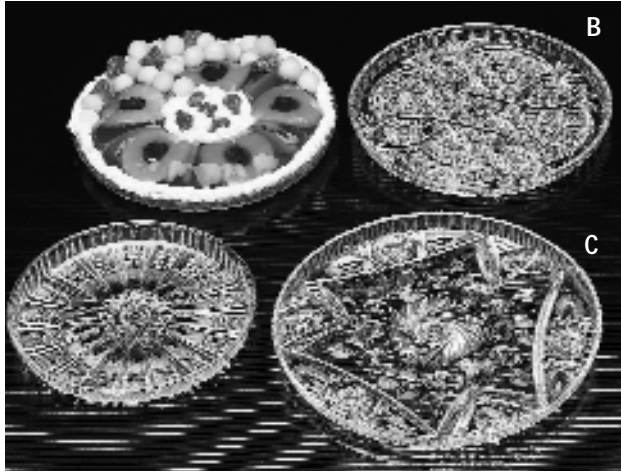

B. 53001604 11" dia. Crystalware Tray
 C. 53001606 12-1/4" dia. Crystalware Tray

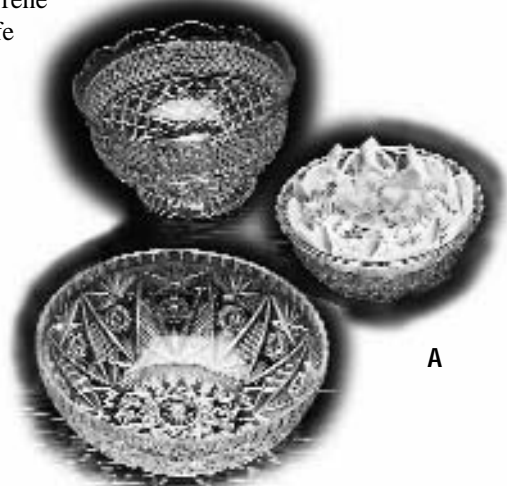

A. 53001603 8" dia, 4" deep Crystalware Bowl



E. 53001608 16" Round Crystalware Tray

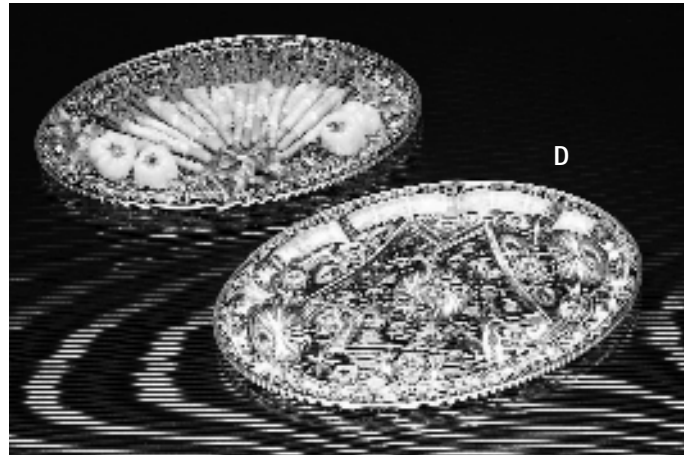

D. 53001607 20"x16" Crystalware Oval Tray

FESTIVAL TRAYS™

- An alternate to glass, crystal, or disposables
- Dishwasher safe
- Break resistant SAN resists food acids & oils
- Safe in temperatures from 0° to 180°F

- F. 57006413..... 13" Round Tray
- G. 57006415..... 15" Round Divided Tray
- 57006416..... 16" Round Tray
- 57006417..... 12.5x7" Rectangular Tray
- H. 57006426..... 22x16" Handled Tray
- 57006439..... 13x19.5" Handled Tray
- I. 57006450..... 15x10.75" Rectangular Tray

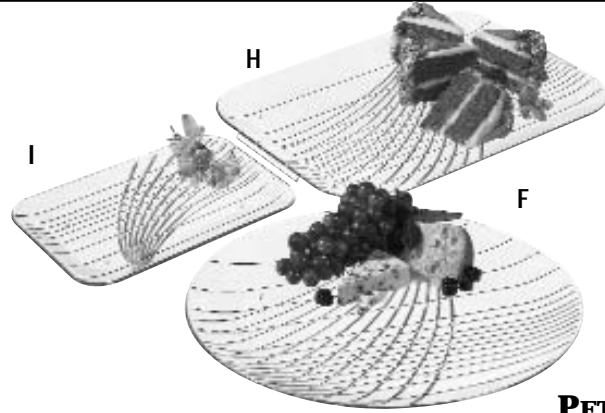

PETAL MIST™ TRAYS

NSF listed trays are perfect for buffets or displaying catered foods. Safe for use in freezers and in temperatures from -40° up to 212°F; dishwasher safe.

- 57030866 16 x 22"
- 57030865 12 x 18"



A

DISPOSABLE SABERT TRAYS

18" round.

- A 50503818Marble-look Platter
- B 50503250Chrome-look Tray
- C 50503550Dome Lid

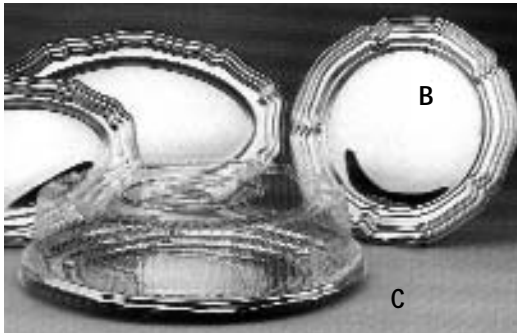

B

C



PLASTIC CRYSTAL-CUT TRAYS & BOWLS

Crystal serving pieces serve it up in style. Handsome, light, yet durable and dishwasher safe, our Crystal Cut party pieces put the "punch" in your party plans.

- 50500029Luau Bowl, 11-1/8 x 7-5/8"
- 505006006" Round Bowl
- 505009254 qt. Bowl, 12-7/8 x 5"
- 5050189612 qt. Large Punch Bowl
- 5050150115" Round Sectional Tray
- 50501510Rectangular Tray, 14-3/8 x 10-3/4"
- 50501913Hostess Tray w/Handles, 19 x 13"
- 505046003-1/2 qt. Bowl, 11 x 4-1/8"
- 50506664Round Chip Dip Tray, 16-3/8"
- 53001600Rectangular Tray, 22-1/2 x 16-1/2"



STAINLESS STEEL TRAY

Polished stainless steel tray ideal for serving & buffet.
44011.....12" Round



STAINLESS CATERER TRAY

Mirror-finished, made of polished stainless steel, with decorative sculptured edges.
5550051019 x 12-3/8 x 1/2"



PETAL MIST 3-TIER DESSERT SERVER

Polycarbonate trays.
6981

ODYSSEY™ CLASSIC CHROME TRAYS

These value priced trays complement casual or formal banquet applications and are ideal for catered events. Various styles to meet your serving needs.

- * Tough chrome plating provides long life
- * Mirror-finish
- * Surface safe for direct food contact
- * Premium product at an economy price
- * *Not dishwasher safe. Recommend cleaning with sponge, mild detergent, and warm water

- 4704726214" Round
- 4704726117-1/2 x 10" Eight Sided
- 4704726320 x 13-3/4" Eight Sided
- 4704726720-3/4 x 15" Victorian Rectangle





**SCHOOL
COMPARTMENT
TRAYS**

6-compartment, right-hand, heavyweight.
57030744 10 x 14-1/2" Tan



57030744

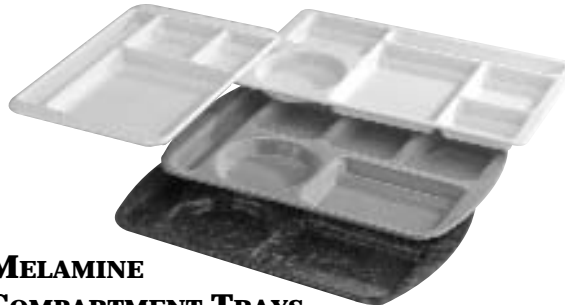

**MELAMINE
COMPARTMENT TRAYS**

Prolon's NSF listed Melamine compartment trays have a hard, scratch resistant surface, easy-to-hold handles, are interstackable and come in many colors.
5059953 10 x 15" mottled



GRIP TITE™ TRAYS

Reinforced trays with permanently bonded rubber liner prevents slipping and sliding of glass and dinnerware.
57030746 . .14" Round Beige
57030747 . .16" Round Beige
57030748 . .22 x 27" Oval Beige



FIBERGLASS CAMTRAYS™

Depend on these hi-impact fiberglass trays with aluminum reinforced edges for years of service. Ask us about our many color, shape and size choices. Personalization available.

- 50502143.....14x18" Antique Parchment
- 50502145.....15x20" Antique Parchment

CAFE TRAYS®

Economical lightweight polypropylene trays are NSF listed, have anti-skid surface, and drying & stacking lugs.



- | | |
|---------------------------------|-------------------------------|
| 57030700.....10x14" Light Brown | 57030732.....12x16" Gray |
| 57030702.....10x14" Dark Brown | 57030734.....12x16" Mauve |
| 57030706.....10x14" Orange | 57030754.....12x16" Teal |
| 57030708.....10x14" Light Brown | 57030758.....12x16" Blue |
| 57030724.....10x14" Buff | 57030762.....12x16" Black |
| 57030726.....10x14" Gray | 57030764.....12x16" Green |
| 57030728.....10x14" Mauve | 57030736.....14x18" Buff |
| 57030752.....10x14" Teal | 57030738.....14x18" Gray |
| 57030760.....10x14" Black | 57030740.....14x18" Mauve |
| 57030710.....12x16" Chocolate | 57030756.....14x18" Teal |
| 57030712.....12x16" Gold | 57030718.....14x18" Dark Brn. |
| 57030714.....12x16" Orange | 57030720.....14x18" Gold |
| 57030730.....12x16" Buff | 57030722.....14x18" Orange |





SALT & PEPPER REFILLERS

Speed refilling with these plastic half-gallon refillers.

- 50509016Pepper Refiller
- 50509019Salt Refiller



SQUARE CUT SHAKER

Traditional square jar with stainless top.

- 450214 2 oz.

MUSHROOM TOP S&P SHAKERS

Classic style shaker with stainless steel mushroom top.

- 4501222 oz. Shaker
- 50501552 oz. Shaker
- 47045660Top only



REGENT SHAKERS

Modern design shakers with chrome tops.

- 4501253 1.5 oz.

TOWER SHAKER

A sleek, modern design, with chrome top and universal holes.

- 55551000 1.5 oz.



BARREL SHAKERS

Tall, tapered shaker with stainless stop.

- 55556310 2 oz.



FLAT TOP SHAKERS

Dent resistant tops and tapered glass jars.

- 4501121 oz. Shaker
- 4502122 oz. Shaker
- 47045658Flat Top Only



HARDWOOD PEPPERMILLS

These are the best wooden peppermills available. Exclusive ceramic grinding mechanisms carry a lifetime warranty. Made of quality hardwood.

- 555105008" Senator Walnut
- 5551055010" Imperial Walnut
- 5551055410" Imperial Beechwood
- 5551075017" Imperial Walnut

ACRYLIC SALT &

PEPPER COMBINATION

Made of clear acrylic. Exclusive ceramic grinding mechanism carries a lifetime warranty.

- 5553008 6-1/2" Coronet

WALNUT PEPPERMILLS

- 440-088" Walnut
- 440-1010" Walnut
- 440-1818" Walnut



8 Oz OIL & VINEGAR DISPENSER

Glass cruets have chrome plated plastic tops, rack is durable chrome.

5556083Cruet Only

5556082Rack Only

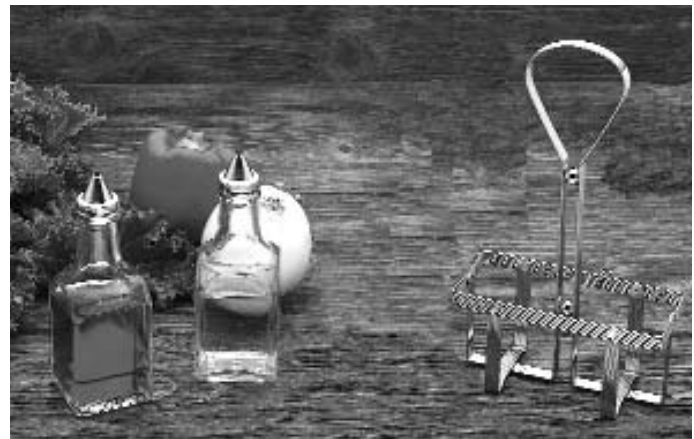

6 Oz OIL & VINEGAR DISPENSER

Glass cruets have stainless steel tops, rack is durable chrome.

4501274Cruet Only

4501275Rack Only



SQUEEZE DISPENSERS

No-drip design helps eliminate mess. Comes in three colors, and sizes of 8 to 24 oz., also with new wide-mouth design.

450142.....8 oz. Clear

45014278 oz. Red

45014288 oz. Yellow

450162.....12 oz. Clear

450162712 oz. Red

450162812 oz. Yellow

5551243124 oz. Clear

5551243224 oz. Red

5551243324 oz. Yellow

5551243416 oz. Clear Wide Mouth

5551243024 oz. Clear Wide Mouth

45014251Clear Cap only

45014252Red Cap only

45014253Yellow Cap only



KETCHUP SAVER

Inexpensive and simple tool eliminates waste.

50546030



**KETCH-ALL
KETCHUP COLLECTOR**

Eli mates waste and mess. Holds 6 ketchup bottles or 2 #10 cans. Allows complete draining and filling with little effort.

59001019



TEARDROP SYRUP DISPENSERS

Teardrop shaped glass jars with chrome or plastic tops.
 55553511.....6 oz. w/Chrome Metal Top
 55553812.....14 oz. w/ Chrome Metal Top
 55553512.....6 oz. w/Chrome Plastic Top
 55553513.....6 oz. Glass Jar Only
 TBL4063R3-Ring Chrome Rack



OPTION DISPENSERS™

Ideal for juices, dressings, batter and mixes. Graduations on side. Clear Lexan jar is dishwasher and microwave safe.

5553300032 oz. Clear w/Gray Top
 5553300248 oz. Clear w/Gray Top
 5553300464 oz. Clear w/Gray Top
 55533006Gray Top Only



PLASTIC TOP SYRUP DISPENSERS

Chrome plated ABS top with 12 oz glass jar.
 55557912 12 oz.



WHITE POLY DISPENSERS

Durable polyethylene jars and chrome metal tops.
 55558411 10 oz



CREAMER/PITCHER

No-drip lip is perfect for cream, syrup or sauces. Made of durable plastic that offers weight and feel of china.

CAR4563 White, 3 oz



ALL PURPOSE DISPENSERS

Dishwasher safe polyethylene jars with wide mouths and white or chrome, thumb-control lids.

55558511.....48 oz. Server Chrome Top
 55558611.....48 oz. Server Plastic Top
 55555511.....32 oz. Server Plastic Top
 55558630.....48 oz. Plastic Top Only
 55555530.....32 oz. Plastic Top Only

CREAMER SYRUP PITCHER

Tapered spout for easy pouring. Safe in temperatures from 0° to 180°F, NSF listed. Made of virtually unbreakable SAN.

50502236 Clear, 2 oz



12 Oz. SUGAR SERVER

12 oz server with glass jar.
 55558011.....Sugar Server Complete
 55558021.....Glass Jar Only



6 Oz. CHEESE DISPENSERS

With a sculptured 6 oz glass jar and stainless steel tops.
 55500474.....Slotted Top
 55500475.....Perforated Top



FLUTED CHEESE SHAKER

Straight sided fluted jar has stainless steel cap with large perforations.
 450101 12 oz.



UNBREAKABLE SHAKERS

These 12 oz. fluted shakers are made of virtually indestructible SAN plastic, are dishwasher safe and stain proof. The sugar top has a self-closing flap.

- A 55500476Cheese Shaker
- B 55500477Dredge Shaker
- C 55500478Sugar Pourer



SLOTTED CHEESE SHAKER

Compact glass jar is perfect for serving grated cheese or hot pepper flakes.
 55500474 8 oz.



S/S TOP SUGAR POURER

Fluted glass body with 12 oz. capacity and stainless steel top.
 45099



CHINA PACKET HOLDER

White ceramic sugar packet holder
 20200020White Diversified
 20271602White Hall China
 20271600Black Hall China



SUGAR PACKET HOLDERS

Durable plastic sugar packet caddies hold 20 sugar packets each.
 57030918Clear
 57030920White



SMOOTH RAMEKINS

Thick-walled, heavy-weight melamine for easy care. Durable, dishwasher safe, with easy-stacking design.

570309281.5 oz. Bone
 555006202 oz. Bone
 570285024 oz. White
 555006606 oz. Bone White
 570309096 oz. Black



CARLISLE® FLUTED RAMEKINS

Perfect for individual service of butter, salsa, condiments. Made of impact resistant SAN, NSF listed and dishwasher safe.

570309101 oz. White
 570309112 oz. Clear
 570309122 oz. White
 570309132 oz. Brown
 570309162.5 oz. White
 570309144.5 oz. White



DEEP SALSA BOWL

Perfect for serving salsa, soups, cheese and sauces. Made of durable, break-resistant SAN, dishwasher safe.

57030908 . .Brown, 8 oz.



TORTILLA SERVER

7 1/2" diameter base holds popular size tortillas. Interlocking base/lid design allows stacking. Withstands temperatures up to 212°F.

57030925

TORTILLA SERVERS

The best tortilla server this side of the Rio Grande! Microwave & dishwasher safe, virtually unbreakable, thermally insulated, stackable, paprika color.

5551000 7 x 1"
 5551001 8 x 2"



MOLCAJATE

Great for salsa, salads, or shrimp cocktail. Authentic charcoal color.

55510068 oz. Molcajete Singular
 55510084 oz. Molcajete Chico





TULIP SHERBET

Ideal for ice cream, nuts, fruit and sauces. Stackable and virtually unbreakable.

57030880 5 oz., Clear



CLAM SHELLS

Perfect for seafood presentations. Durable SAN is resistant to oils and acids, and is dishwasher safe.

5703088222 oz White

570308845 qt. White



OYSTER CUP

Made of durable, break-resistant SAN. Holds 2 3/4 oz.

57030242 Clear

STAINLESS STEEL SAUCE CUPS

Sized for individual condiment service, these Sauce Cups retain temperature longer to help reduce food waste.

450378412.5 oz.

450378421.5 oz.



STAINLESS STEEL SHERBET DISH

Put your dessert on a pedestal with this scalloped top sherbet dish. Mirror finish stainless steel and a wide gadroon base.

4503728 3.5 oz.

GRAVY/SAUCE BOAT

Classic, footed, stainless steel gravy boats have a gadroon edge, and well balanced design for easy pouring.

47047573 3 oz.



STAINLESS STEEL AU GRATIN

Go straight from the oven to the table with these Au Gratin dishes, to keep your servings piping hot. Prep and serve in the same dish.

470474088 oz. Round

4704742212 oz. Oval





WATER PITCHER

This tall, elegant pitcher is made of satin-finish stainless steel. Ice guard reduces spills.

4503754 2 qt.



BUTTER MELTER

Chrome tripod stand. Stainless steel pan has handle and pour spout.

450545



SNAIL TONG

This mirror-finish stainless steel tong provides a comfortable, secure grip. With a durable, self-closing spring.

5551612 6 in.



SNAIL FORKS

Comfortable 2-tine stainless steel forks with black plastic or plain handles.

55516147 in. Plain Handle

55516107 in. Plastic handle



TEAPOT

Value priced, these wide-mouth stainless steel servers are easy to clean and fill.

4503700 10 oz., closed handle



GOOSENECK TEAPOT

Traditional styling compliments any table. Insulated hollow handle and hinged cover make serving a breeze.

4503704 10 oz



BELL CREAMERS

These classic, stainless bell creamers are excellent for serving cream, sauces and dressings.

4503701 . . .3 oz.

4503702 . . .5 oz.



ACRYLIC TOOTHPICK DISPENSER

Smoke and clear color, holds toothpicks up to 2-5/8". 3-1/2 x 2-3/4 x 4"

55585031



TOOTHPICK DISPENSERS

Available in stainless steel or translucent plastic, for round toothpicks. 4.5" high.

57030940Clear

55511000Stainless steel



ACRYLIC TOOTHPICK DISPENSER

Durable acrylic construction with see-through design.

55585031 4.5 in.



**BISTRO™
FLUTED TUMBLERS**

Made of break resistant SAN, these easy stacking tumblers are dishwasher safe.

- 5703060410 oz. Clear
- 5703060612 oz. Clear



STACKABLE™ TUMBLERS

Durable SAN reduces breakage, while textured exterior hides wear and tear. Tapered sides for easy stacking, with lugs to prevent jamming.

- | | |
|-----------------------------|----------------------------|
| 570306105 oz. Amber | 5703064412 oz. Ruby |
| 570306125 oz. Clear | 5703065016 oz. Amber |
| 570306145 oz. Ruby | 5703065216 oz. Clear |
| 570306208 oz. Amber | 5703065416 oz. Ruby |
| 570306228 oz. Clear | 5703066020 oz. Amber |
| 570306248 oz. Ruby | 5703066220 oz. Clear |
| 570306309.5 oz. Amber | 5703066420 oz. Ruby |
| 570306329.5 oz. Clear | 5703067032 oz. Amber |
| 570306349.5 oz. Ruby | 5703067232 oz. Clear |
| 5703064012 oz. Amber | 5703067432 oz. Ruby |
| 5703064212 oz. Clear | |



CRYSTALON® STACK-ALL TUMBLERS

Update your tabletop with this distinctive look. Stylish ribbed texture offers better grip, and break-resistant SAN reduces breakage. Stackable, dishwasher safe, and will not jam.

- 570306788 oz. Amber
- 5703069616 oz. Amber



PEBBLE OPTIC™ TUMBLERS

Attractive pebbled exterior hides scratches, with a thick-walled construction for a sturdy feel. Made of dishwasher safe, virtually unbreakable SAN.

- 555003408 oz. Clear
- 505022089.5 oz. Clear
- 505022109.5 oz. Ruby
- 5050221612 oz. Clear
- 5050222416 oz. Clear
- 5050222816 oz. Smoke





Ask your RESCO rep about Custom Menu Covers.

MENU COVERS

Clear sewn menu covers with durable colored binding and brass tipped corners.

11" x 8 1/2" Panels

55583010.....Double Clear with Black

55583014.....Double Clear with Maroon

55519607.....Double Clear



MENU/CARD HOLDERS

Stainless steel spring clip on a stamped base
55500437



CRUMB SWEEPER

Eliminate the problem of brushing crumbs by hand into a napkin. Can be carried in an apron pocket. Cover snaps off for easy cleaning. mahogany colored hi-impact styrene case. White nylon bristles twisted in rust-proof steel wire. Nylon roller parts. 2-7/8 x 5-3/8"

808408



CRUMB SWEEPER

Gold, anodized aluminum with a pocket clip. Helps maintain table top free of crumbs.

55500430 6"

STAINLESS STEEL NAPKIN DISPENSER

For Standard 3 1/2 x 7" napkins, with a capacity of 150 napkins.

540221 4 x 4 1/2 x 7 1/2"



5053810



5053802

5053825



STRAW DISPENSERS

For 7-1/2" to 8-3/4" Jumbo or Super Jumbo straws.

3802Unwrapped (500 straws)

3810Wrapped (250 straws)

3825Unwrapped (400 straws, double sided)



THERMO-PLATES®

Keep your servings hot with these stainless steel platters and polyester bases specially formulated to hold heat . Stackable, dishwasher safe..

- 5550032212" S/S Thermo-Plate
- 55500321Black Thermo-Base for 12"
- 5550032611" S/S Thermo-Plate
- 55500325Black Thermo-Base for 11"



CAST IRON PLATTERS & UNDERLINERS

Excellent for cooking and serving steaks or hamburgers.

- 4040800015" Oval Cast Iron (Lodge)
- 44015115" Oval Cast Iron (Imported)
- 440152Wood Underliner for 15"
- 4400919" Round Cast Iron (imported)
- 440092Wood Underliner for 9" (imported)



SERVING SKILLET

Lightweight, sandcast aluminum skillet and real birchwood base.. Hand wash.

- 555003247 1/4 x 9 1/2" Skillet
- 555003239 x 12" Birchwood Base



SALAD BOWLS

Dishwasher safe, impact resistant melamine bowls are in compliance with FDA standards.

- 470310005.75" Birch
- 470310046" Birch
- 470310076" Black
- 470310108" Birch
- 470310138" Black



SALAD SERVICE

These woven wood bowls are durable and dishwasher safe .Mahogany color

- 53001620Fork & Spoon Set 12"
- 530016225.5" Round Bottom Bowl
- 530016246" Flat Bottom Bowl
- 530016268" Flat Bottom Bowl



ACRYLIC PEBBLED BOWLS

Pebbled exterior resists scratching, smooth interior is unaffected by oils or acids. NSF listed, dishwasher safe, high-gloss acrylic construction.

5703085110" Round

5703085212" Round

5703085416" Round

5703085518" Round



PETAL MIST® BOWLS & PLATES

Petal Mist's delicate design and floral shaped edge gives an elegant appearance. Made of break-resistand polycarbonate, safe in temperatures from -40°F to 212°F. NSF listed.

570308606" Clear Petal Mist Bowl

570308687-1/2" Clear Petal Mist Bowl

570308619" Clear Petal Mist Bowl

5703086212" Clear Petal Mist Bowl

5703086318" Clear Petal Mist Bowl

5703086416" Clear Petal Mist Round Tray

5703086512 x 18" Petal Mist Tray

5703086616 x 22" Petal Mist Tray



CAMWEAR® RIBBED BOWLS

Stylish, contemporary appearance. Virtually unbreakable polycarbonate construction guarantees our ribbed bowls won't break like glass, dent like stainless steel, or chip and crack like acrylic.

505021809 x 12" Black Rectangular

5050218110.25 x 14.5" Black Rectangular

5050218214.25 x 19.33 Black Rectangular

505021838" Black Round Bowl

5050218410" Black Round Bowl

5050218512" Black Round Bowl

5050218615" Black Round Bowl

5050218718" Black Round Bowl

CAMWEAR® PEBBLED BOWLS

Textured on the outside for an elegant look, smooth on the inside for easy cleaning. made oif virtually unbreak-able polycarbonate for years of dependable service.

505021758" Pebbled Bowl

5050217610" Pebbled Bowl

5050217712" Pebbled Bowl

5050217815" Pebbled Bowl

5050217918" Pebbled Bowl



CARLISLE
FoodService Products

MUNCHIE BASKETS

Excellent for serving deli sandwiches or specialty appetizers! Stackable and dishwasher safe. Ask us about imprinting your name and logo.

- 5703440302 ...5.33 x 7.33" Black
- 5703440305.33 x 7.33" Red
- 5703440301 ...5.33 x 7.33" Green



BREAD & BUN BASKETS

Extremely economical plastic baskets are great for all types of food such as sandwiches, fries, ribs, chips & bread.

- 57030900.....9" Brown Oval
- 57030901.....9" Green Oval
- 57030902.....9" Red Oval
- 57030903.....9" White Oval
- 57030904.....9" Yellow Oval



CHICAGO PLATTER BASKETS

Durable, rectangular, polypropylene baskets. 10.5 x 7 x 1.5" oval. Perfect shape for burgers, sandwiches, fries, & entrees.

- 555010761Red Oval
- 555010762Blue Oval

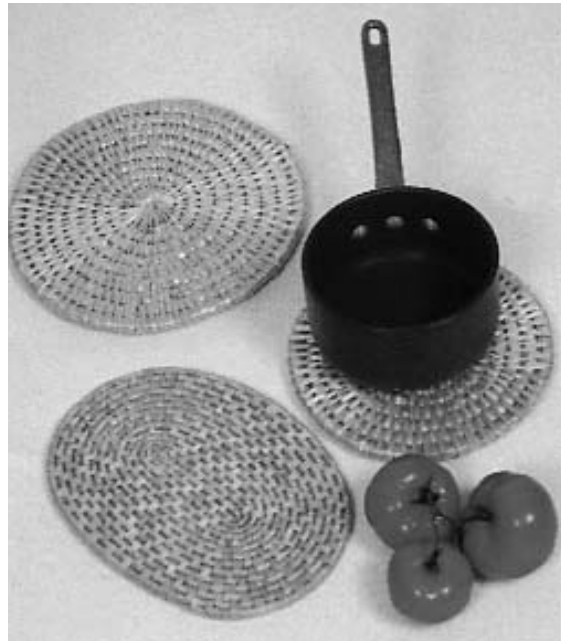

HANDMADE STRAW HOT PADS

Round woven straw coil hot pads from Willow Specialties.

- 55585588Oval 11 x 8"
- 55585589Round 11"



A

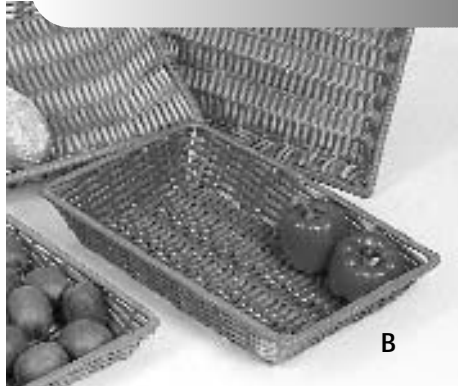

B

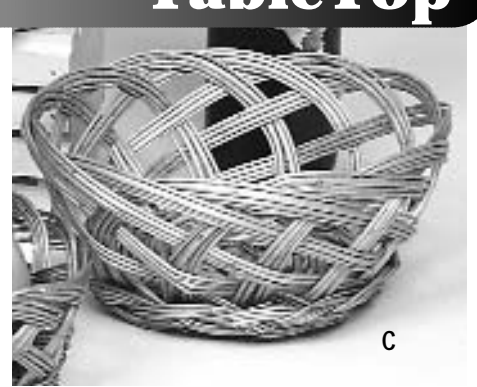

C

WILLOW BASKETS

The finest in woven willow baskets from Willow Specialties.

- A 53010105.....10 x 8.5 x 3.5" Split Willow Split Basket
- B 55511800.....10 x 7.5 x 3.5" Rectangle Poly-Line Basket
- C 55511802.....9" Round Open Weave Bun Basket
- D 55500117.5 x 12 x 5" Display Basket
- E 55500217 x 12 x 10" w/5" front Display Basket
- F 55500323 x 17 x 9" w/5" front Display Basket
- G 55500418 x 11.5 x 4" Tray Basket
- H 55500514 x 10 x 2.5" Tray Basket
- I 55500616 x 11 x 3.5" Tray Basket
- J 55500714" Dia. X 4" H. Round Basket
- K 55500810 x 7.5 x 3.25" Oval Basket
- L 55500921" x 16.5 x 5" Market Basket

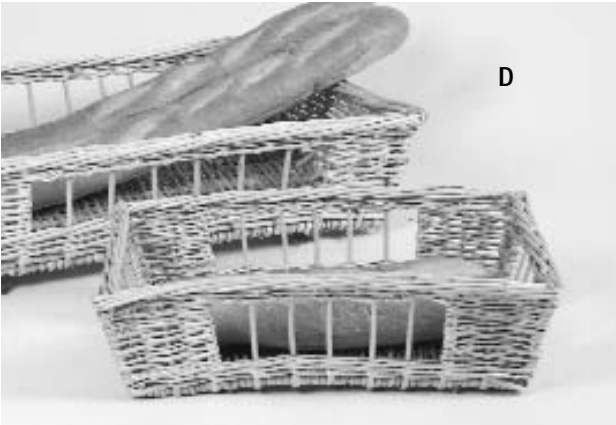

D



E



F

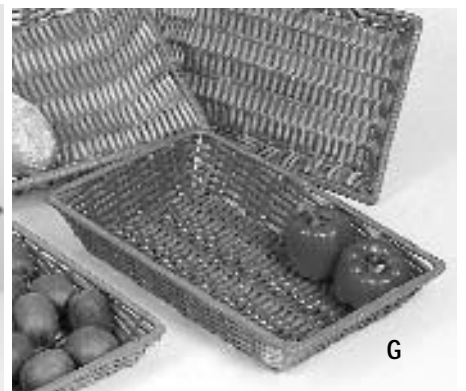

G



I & J



K



L



BAMBOO BASKET

Basket is tightly woven of narrow strand bamboo in a natural color.
53010103Oval 9 x 6.75 x 2"



A



B

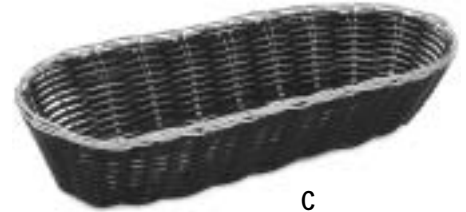

C

BLACK VINYL BASKETS WITH GOLD TRIM

Made of durable black vinyl with gold wire trim. easy to wipe clean.
A 53010115Round Roll Basket, 8.5" dia x 2.5" high
B 47047208Oval Roll Basket, 9.5 x 6.75 x 2.75"
C 53010107Long Cracker Basket, 8.5 x 3 x 2"



POLYPROPYLENE BASKET

Round poly willow basket with wire reinforced top.
530101099 x 3"



POLYPROPYLENE BASKET

Oval poly willow basket with wire reinforced top.
530101139 x 6 x 3"



POLY CRACKER BASKET

Oblong poly willow basket with wire reinforced top.
530101119 x 3 x 2"



POLY BUN BASKET

Brown oval bun basket made of polypropylene, 10 x 7.5 x 3.25"
555008Brown



ROUND FERN BASKET

Smooth polypropylene. Round, easy to clean.
555010779x3" round



HANDMADE WOVEN BASKET

Woven from smooth polypropylene cord, no jagged edges. Will not absorb oils or odors, easy to wipe clean.
57006504Black 9x6x2.75" oval

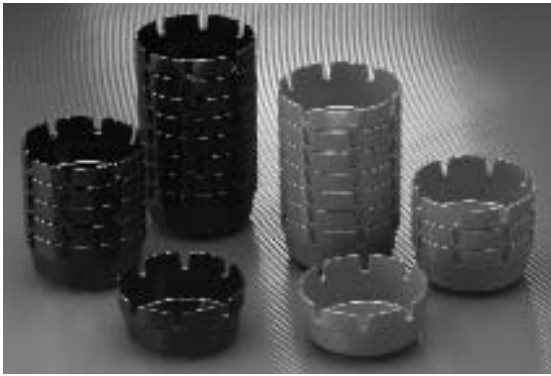

**STACKING
DEEPWELL ASHTRAYS**

Made of black phenolic melemine, will not blister or scorch.
570309423.88 x 1.75"



CAMWEAR CONDIMENT JARS

Clear and virtually indestructible.
8 oz. capacity
50502151Jar & Cover



CAKE COVER

Clear acrylic cover is dishwasher safe, keeps cake & pastries fresh longer.
5703087412" Dia.

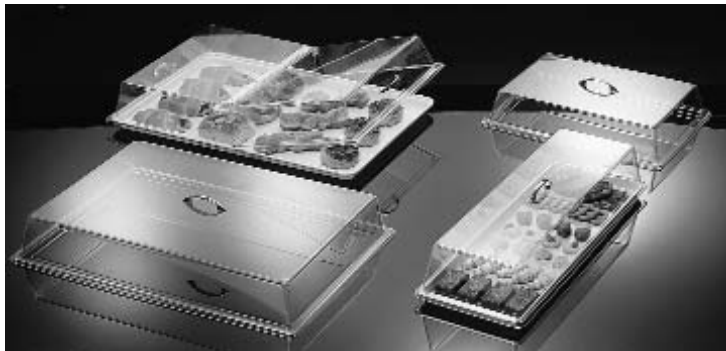

PASTRY TRAY COVERS

Clear covers offer the best visibility in bakeries & delis. Stainless steel handle and hinge, clear acrylic construction.
5703087518 x 13 x 4" Cover
5703087026 x 18 x 4" Cover
5703087126 x 18 x 4" Cover
5703087320 x 12 x 4" Hinged Cover



**STAINLESS
CAKE STAND**

Attractive stainless steel display stand will give desserts better visibility.
4503300.....13" Dia, 7.13"H



**ACRYLIC
CAKE STAND**

Made of black, dishwasher-safe acrylic.
5702559.....2.25" H
5702563.....4.88" H



POLYCARBONATE PASTRY & CHAFER COVERS

Excellent for self-serve or attendant-serve. Hinged lid for sanitary use. Durable polycarbonate construction. Not warranted for steam table use. Caution: handles can get extremely hot in continuous use.
555773.....18"x26" hinged

CAL-MIL

**SLANT FRONT
PASTRY CASE**

U-Build it; you save, easy assembly! Slant front, rear door, self-serve front door, stainless steel hinges, with three 10 x 14" trays
555963 11.5"w x 17"d x 17"h

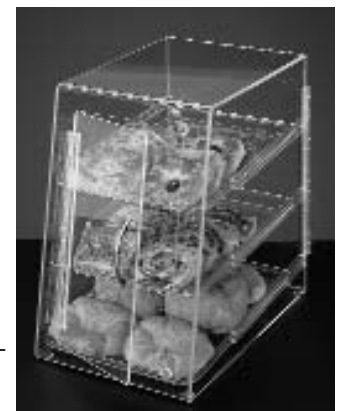



PASTA/SOUP BOWL

This western "Rodeo" style, 13 oz bowl is perfect for serving salad, soups and pasta.

555139.....9.5"



ACRYLIC BELL PEBBLED BOWLS

555848.....5 qt, 12" Bell

555849.....10 qt, 15" Bell



ACRYLIC PEBBLED BOWLS

555835.....20 qt, 18"



IRON FRAME WRITE-ON SIGN

9 x 15" writing area. Stable rectangle base. Dry erase pens sold separately

555898.....Write-On Sign

55501870Dry Erase Markers



RESERVED SIGN

555004312 x 6

CAL-MIL

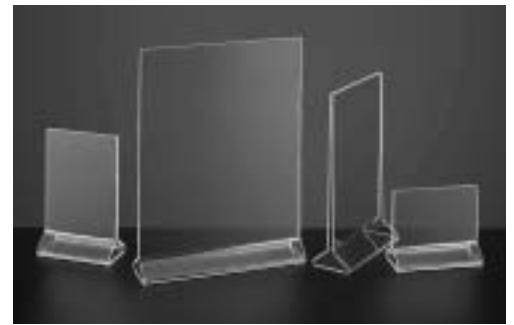

CLEAR CARD HOLDERS

505517.....4.5"Wx3.5"H

505518.....5.5"Wx3.5"H

CONTEMPORARY SYMBOL SIGNS

Complete international and directional signage system with international symbols. 3 x 9" signs with adhesive backing.

58056101 "Exit"

58056102 "Rest Rooms"

58056103 "Mens"

58056104 "Womens"

58056105 "Employees Must Wash"

58056107 "Not Responsible for"

58056112 "Employees Only"

58056114 "No Smoking"



BRILLE SYMBOL SIGNS

These 6 x 9" signs have adhesive backing for easy mounting. Meets requirements of the American With Disabilities Act.

5055630 "Women" Accessible

5055631 "Men" Accessible

5055632 "Accessible"

5055633 "Restroom"

5055634 "Women"

5055635 "Men"



ARC DE TRIUMPH WRITE-ON BOARD

The Arc de Triumph was designed and engineered to fill the need for a contemporary styled write-on board that could handle tough daily use. Comes with four markers. Markers store in the frame for convenience. 18 x 24"

ARC-18-WH-WHWO



PARK AVENUE TELLER MENU BOARD

The stunning oak frame compliments the modern, gold fluted stand. Comes with solid weighted base. Hinged frame allows for sufficient storage of all messages when not in use.

55511112



WRITE-ON 2000 BOARDS

Your message will leap off our special black surface once you have written with our hi-intensity color markers. Write-On 2000 appears to be illuminated, although no electricity is required, and your sign can be placed anywhere.

WO-2000-18-0



LIGHT WRITER & EASEL

Light Writer's superior lighting system remains brilliantly illuminated, even in a brightly lit room. The colorful glow of whatever you draw on them naturally attracts people's attention. Your message is enhanced with the use of 21 tracing templates included. Supplied complete with the templates, 4 fluorescent markers and the integral scratch resistant, acrylic surface. Our 401 Easel has a natural lacquer finish. Real Brass hardware makes this an attractive easel, 32"W x 60"H. Some assembly required

LWE-2528.....Light Writer Sign

55501842#401 Easel/Oak for Light Writer

55501870Write on Markers (4ea)





STAINLESS STEEL TUBULAR FRAME CART

Ideal for moderate weight loads and all-purpose back-of-the-house duties as well as constant use over various standard floor surfaces. Tubular frame incorporates handles with U-frame construction for structural strength. 20 gauge stainless steel shelves have reinforced edges for heavy loads. Easy to clean and sanitize, simply steam clean or wipe down. NSF listed.

450172343 Shelf, 17 1/2"L x 27"W x 35 3/4"H



HEAVY DUTY TOTE-ALL LUG

Made for heavy loads. Winholt 104432
555104432 ...Gray; 16 x 26 x 8"



STANDARD BUS BOXES

Reliable tote for busing flatware and dishes. With reinforced ribbed bottom, and ant-locking stacking ribs. Impact resistant. 20 x 15 x 7"D. NSF listed.

45010727Gray
450107271Black



SAVE-ALL™ COMPARTMENTED BUS BOX

Combines silverware tray and heavy duty bus box to save time clearing tables. Stackable. Grease, scuff & stain resistant

57030930Brown Divided
4501071Gray Cutlery Bin
45010711Black Cutlery Bin



STANDARD BUS BOXES

Sturdy boxes with reinforced rims reduce bending, and Comfort Curve™ handles. Stackable. 20 x 15".

58033511Brown, 7" D
5803351Gray, 7" D
5803349Gray, 5" D
58033491Brown, 5" D



STAINLESS STEEL 3-SHELF CARTS BY LAKESIDE

Medium duty carts, 400 lb capacity. Ideal for moderate weight loads and all-purpose back-of-the-house duties as well as constant use over various standard floor surfaces. Durable, 16 ga. unitized electronically welded angle leg frame. 20 gauge stainless steel reinforced shelves. Protective bumpers on legs and handle safeguard furnishings. Sound deadening panels under shelves restrict vibrations and noise. Please see the Equipment Chapter for more bussing and utility carts.

450456.....16 3/4"L x 27 5/8"W x 33 3/8"H (411)
450436.....19"W x 31"W x 33 3/8"H (422)

SILVER BIN

Fits all standard sized carts, makes bussing easy. Gray, 15 1/2 x 6 3/8 x 6 1/2"

450238.....Gray
4502381.....Black



REFUSE BIN

Extra deep for paper and food waste. Stainless steel brackets support heavy loads. Plastic carts require hangar rod assembly.

16 x 8 1/2 x 21 5/8"

4502391.....Black*
450237.....Gray

*for cantilever & tubular cart

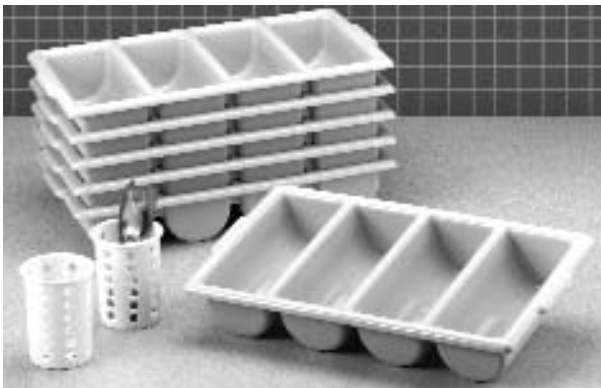

CUTLERY BINS & CYLINDER

Bins made of high density polyethylene, stackable and FDA approved material. Flatwear cylinder is white polypropylene.

4501071.....Gray Bin 21 x 12 x 4"
45010711.....Black Bin 21 x 12 x 4"
5558802.....Poly Silverware Cylinder



PLASTIC SILV-A-TAINER

Made of tough gray plastic, easy to clean. Cylinders sold separately.

4501084.....Silv-A-Tainer 6-hole
47099710.....S/S Cylinder



S/S SILV-A-TAINER

High gloss S/S with rubber feet. Cylinders sold separately.

4501096.....Silv-A-Trainer 6-hole
4501094.....Silv-A-Trainer 4-hole
47099710.....S/S Cylinder



CYLINDER TRANSPORT RACK

Holds 6 cylinders.

Cylinders sold separately.

4501090.....15 x 10 x 11 1/8"
47099710.....S/S Cylinder

HEAVY DUTY BUS BOX

Heavy duty tote for bussing flatware and dishes. 20 x 15 x 5". NSF listed.

4501072.....Gray Bus Box
45010740.....Gray Bus Box Cover



UNDER COUNTER DISH BOX

Compact size fits narrow spaces, for heavy duty use.

4501073.....Gray, 20 x 12 x 6"



CAMBRO BOOSTER SEATS

Contoured seats, high sides, wide square bases and non-skid surfaces make the Cambro Booster a safe way to keep toddlers comfortable.

- 50520131Brown
- 50520157Beige
- 50520158Red



HARDWOOD HIGH CHAIRS

Attractive, stackable high chairs are made of durable, stain-resistant hardwood, with a 27" arm height. Wide stance prevents tipping.

- 70740005Walnut Finish
- 70740004Natural Oak Finish



STURDY CHAIR™

Strength and stability, attractive styling. Easy to clean, with removeable tray. With casters

- 5807805Platinum Sturdy Chair
- 5807815Platinum Tray



WOOD HIGH CHAIRS

Imported wood high chair, not assembled.

- 70739000Light Oak Finish
- 70739001Dark Walnut Finish



57030835

PLASTIC TRAY STAND

Provides maximum strength and durability. Sanitary, non-porous and non-corrosive, cleans with a damp cloth. 30 1/2" high.

- 57030835Walnut color

METAL TRAY STAND

Chrome steel stand, 31" high; 19 x 16-1/2" top, nylon straps

- 80876000

TRAY CHIC TRAY STAND

Handcrafted, subtly turned walnut, with a superb furniture finish becomes the ultimate look in tray stands. It is not only handsome, but rugged as well, with machine bolts, threaded insert fastening, rubber friction rings, and special Nyl-Strap automotive belting.

- TS-TRAY-CHIC17 x 16-1/2 x 30" h



WOOD TRAY STAND

Well balanced, folding stands. Hardwood construction for upscale appearance

- 70700500Walnut Finish



Pots & Pans

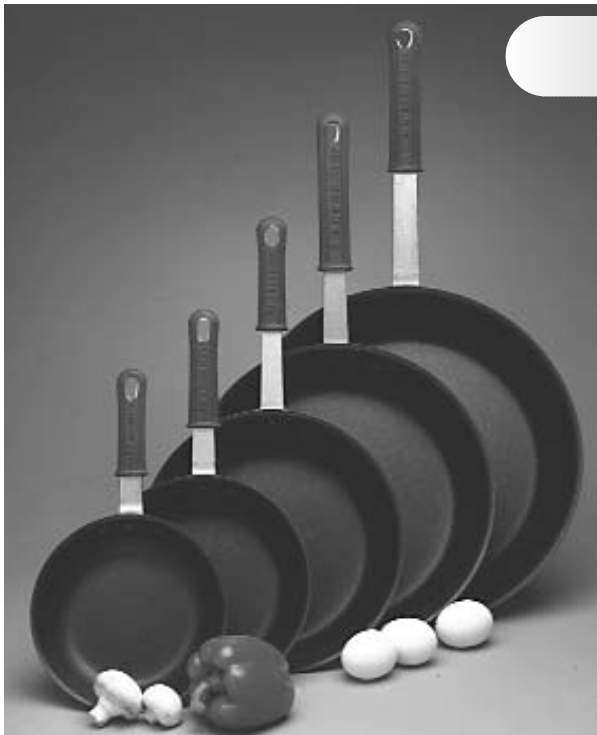

WEAR-EVER CERAMI GUARD® FRY PANS

CeramiGuard withstands the abuse of metal utensils better than any other no-stick fry pan coating, even under high heat conditions.

- 430400737" CeramiGuard
- 430400838" CeramiGuard
- 4304010310" CeramiGuard
- 4304012312" CeramiGuard
- 4304014314" CeramiGuard



WEAR-EVER SILVERSTONE® NON-STICK FRY PANS

New and improved non-stick coating has exceptional release qualities, with good scratch resistance. Perfect for foods with high sugar content.

- 430400717" Silverstone Frypan
- 430400818" Silverstone Frypan
- 4304010110" Silverstone Frypan
- 4304012112" Silverstone Frypan
- 4304014114" Silverstone Frypan



NATURAL ALUMINUM FRY PANS

Choose a traditional cooking option with classic Wear-Ever Professional natural finish fry pans. They look attractive and provide years of dependable service.

- 43040077" Natural Frypan
- 43040088" Natural Frypan
- 430401010" Natural Frypan
- 430401212" Natural Frypan
- 430401414" Natural Frypan



WEAR-EVER COOL HANDLES

Easily handle hot fry pans. Even when placed in the oven or in an open flame, Cool Handles will not burn, smoke or smolder.

- 4303009for 12 & 14" Fry Pans
- 4303010for 8 & 10" Fry Pans
- 4303011for 7" Fry Pans



NON-STICK ECONOMY FRY PANS

Aluminum fry pans with non-stick coating.

- 4401077-1/2" Non Stick Frypan 1100 alum.
- 4401088-1/2" Non Stick Frypan 1100 alum.
- 44011010" Non Stick Frypan 1100 alum.
- 44011212" Non Stick Frypan 1100 alum.
- 4402077-1/2" Non Stick Frypan 3003 alum.
- 4402088-1/2" Non Stick Frypan 3003 alum.
- 44021010" Non Stick Frypan 3003 alum.
- 44021212" Non Stick Frypan 3003 alum.



VOLLRATH STEELCOAT™ INDUCTION FRY PANS

These rapid-heating carbon steel fry pans take full advantage of induction cook tops, and work flawlessly on conventional ranges too!

- 470599008.5" Induction Fry Pan
- 470599109.38" Induction Fry Pan
- 4705992011" Induction Fry Pan



STEELCOAT x3™ ALUMINUM FRY PANS WITH NON-STICK INTERIOR

Triple-layer SteelCoat x3™ coating has been subjected to rigorous lab and field testing. In an independent lab test comparing SteelCoat x3™ versus Vollrath's top competitor's premium non-stick, SteelCoat x3™ showed more than three times the resistance to wear when subjected to repeated drawing of a Scotch-Brite™ pad across the pan surface.

Your SteelCoat x3 will last 3 times longer!

470676077" SteelCoat x3 w/GatorGrip handle

470676048" SteelCoat x3 w/GatorGrip handle

4706761010" SteelCoat x3 w/GatorGrip handle

4706761212" SteelCoat x3 w/GatorGrip handle



POWERCOAT2™ NON-STICK ALUMINUM FRY PANS



This dual layer ceramic-reinforced coating on pans constructed from impact-resistant 3004 aluminum offer excellent commercial performance at an affordable price.

PowerCoat2 pans have improved durability by 250%!

470678077" PowerCoat2 w/GatorGrip handle

470678088" PowerCoat2 w/GatorGrip handle

4706781010" PowerCoat2 w/GatorGrip handle

4706781212" PowerCoat2 w/GatorGrip handle



GATORGRIP® HANDLES

Patented black handle is permanently bonded, will not slide off and eliminates food traps and cleaning headaches.

Oven safe to 450°F.

DURA-WARE STAINLESS STEEL CLAD FRY PANS

The finest 18-8 stainless interior is permanently bonded to hard aluminum body to create the ultimate fry pan for any foodservice environment. Aluminum body ensures maximum heat transfer throughout the pan, eliminates hot spots and scorching. Easy care stainless interior is incredibly durable and will not react with food or discolor sauces; NSF listed

40403048S/S Clad 8" Frypan

40403049S/S Clad 10" Frypan

40403050S/S Clad 12" Frypan



Pots & Pans



VOLLRATH TRI-PLY STAINLESS STEEL STOCK POTS

The finest stock pot for rough, everyday commercial kitchen use. An inner and outer layer of 18-8, type 304 S/S, bonded to a core of highly-conductive carbon steel. Strong, corrosion-resistant and offers superior heat transfer.



- 4508010.....S/S 10 Qt. Stock Pot
- 4508012.....S/S 12 Qt. Stock Pot
- 4508016.....S/S 16 Qt. Stock Pot
- 4508020.....S/S 20 Qt. Stock Pot
- 4508025.....S/S 20 & 24 Qt. Stock Pot Lid
- 4508024.....S/S 24 Qt. Stock Pot
- 4508040.....S/S 40 Qt. Stock Pot
- 4508045.....S/S 40 Qt. Stock Pot Lid
- 4508060.....S/S 60 Qt. Stock Pot
- 4508065.....S/S 60 Qt. Stock Pot Lid



ALUMINUM STANDARD STOCK POT

Sanitary open bead stock pots are great for light to medium use operations.. Extra dent-resistant 3004 aluminum alloy with spot-welded handles. NSF listed

- | | <u>Use Cover</u> |
|-------------------------------------|------------------|
| 4304302.....2 gal. Stock Pot..... | 4304189 |
| 4304303.....3 gal. Stock Pot..... | 4304190 |
| 4304305.....5 gal. Stock Pot..... | 4304192 |
| 4304306.....6 gal. Stock Pot..... | 4304192 |
| 4304307.....7.5 gal. Stock Pot..... | 4304192 |
| 4304310.....10 gal. Stock Pot..... | 4304194 |
| 4304315.....15 gal. Stock Pot..... | 4304196 |

Lincoln WFAF-FVFR

ALUMINUM PREMIER® STOCK POT

Double thick tops and bottoms make these stock pots ideal for medium to heavy use. Extra dent-resistant 3004 aluminum alloy with spot-welded handles. NSF listed.



- 4304253.....32 qt. Premier Stock Pot
- 4304254.....40 qt. Premier Stock Pot



ECONOMY ALUMINUM STOCK POTS

Standard weight aluminum stock pots will give you years of reliable service. Riveted handles.

- 4403120.....12 qt. Stock Pot.....use Cover 4403121
- 4403160.....16 qt. Stock Pot.....use Cover 4403161
- 4403200.....20 qt. Stock Pot.....use Cover 4403201



STAINLESS STEEL STOCK POTS

Long lasting stainless steel with specially conductive bottoms for even heat distribution.

- 44050132.....25.5 Qt. S/S Stock w/Lid Lacor
- 44050136.....38 Qt. S/S Stock w/Lid Lacor



CARLISLE
FoodService Products



**DURA-WARE HEAVY WEIGHT
ALUMINUM STOCK POTS**

Heavy weight cookware is designed from 1/4" aluminum alloy for optimal hardness and durability; NSF listed. 3003 alloy allows cookware to heat rapidly and retain even heat. Perfect for preparing soups, pasta, or long-simmering stocks and sauces

	<u>Use Cover</u>
4040304020 qt. Alum. HD Stock Pot	40403078
4040301324 qt. Alum. HD Stock Pot	40403078
4040301440 qt. Alum. HD Stock Pot	40403082
4040304260 qt. Alum. HD Stock Pot	40403084

DURA-WARE ALUMINUM STOCK POTS

Traditional weight satin finish cookware is an economical choice for busy foodservice operations. Quality construction with a thick base for superior thermal conductivity. With sanitary open bead rolled edge. NSF listed.

	<u>Use Cover</u>
404030008 qt. Alum. Stock Pot.....	40403076
4040300110 qt. Alum. Stock Pot.....	601010
4040300212 qt. Alum. Stock Pot.....	40403080
4040300316 qt. Alum. Stock Pot.....	40403078
4040300420 qt. Alum. Stock Pot.....	40403078
4040300524 qt. Alum. Stock Pot.....	40403078
4040300632 qt. Alum. Stock Pot.....	40403081
4040300740 qt. Alum. Stock Pot.....	40403082
4040300860 qt. Alum. Stock Pot.....	40403084

CARLISLE
FoodService Products



**DURA-WARE HEAVY WEIGHT
ALUMINUM SAUCE POTS**

Heavy weight cookware is designed from 1/4" aluminum alloy for optimal hardness and durability; NSF listed. Double thick top edge and base for superior strength and shape retention. 3003 alloy allows cookware to heat rapidly and retain even heat. Wider diameter pots with lower sidewalls for smaller preparations. Use for foods cooked with liquid over medium heat that require frequent stirring or handling.

4040302514 qt. Alum. Sauce Pot
4040302626 qt. Alum. Sauce Pot
4040304520 qt. Alum. Sauce Pot
4040304640 qt. Alum. Sauce Pot



Lincoln WEAR-EVER

WEAR-EVER STANDARD DOUBLE BOILER

The inside container has a flat bottom for even cooking of delicate sauces, puddings and pie fillers. NSF listed; Bottoms and covers are made of dent-resistant 3004 aluminum alloy.

- 4304355.....5.5 qt. Double Boiler
- 4304370.....17.5 qt. Double Boiler



WEAR-EVER SUPER-STRENGTH BRAZIER

Sturdy construction and large diameter cooking area for braising large pieces of meat., while shallow heights permits small amounts of liquid to be used.

- 4304096.....18 qt., 16" Brazier Pan; use Cover 4304196

DURA-WARE ALUMINUM COVERS

Tight fitting aluminum covers fit Dura-Ware pans with spot-welded loop handles.

- 404030768.5" Duraware Cover
- 404030779.5" Duraware Cover
- 4040307910" Duraware Cover
- 4040308011" Duraware Cover
- 4040307812" Duraware Cover
- 4040308113" Duraware Cover
- 4040308214" Duraware Cover
- 4040308416" Duraware Cover
- 4040308518" Duraware Cover



ECONOMY ALUMINUM SAUCE PANS

Standard weight aluminum taper side sauce pan will give you years of reliable service. Riveted handles.

- 4402010.....1.5 qt. Sauce Pan.....use Cover 4402011
- 4402020.....2.75 qt. Sauce Pan.....use Cover 4402021
- 4402030.....3.75 qt. Sauce Pan.....use Cover 4402031
- 4402040.....4.5 qt. Sauce Pan.....use Cover 4402041
- 4402060.....6.5 qt. Sauce Pan.....use Cover 4402061
- 4402070.....7 qt. Sauce Pan.....use Cover 4402071
- 4402100.....10 qt. Sauce Pan.....use Cover 4402101



DURA-WARE PASTA COOKER

ideal for pasta, vegetables, and seafood. Save time, energy, and space by cooking multiple portions in one pot. Stainless steel inserts with 1/8" holes feature cool-touch handles and can be hooked on the side of the pot for easy draining. Complete unit includes 20 qt pot and inserts.

- 40403090Quarter size Sectional Pasta Cooker



Lincoln WEAR-EVER



**WEAR-EVER SUPER-STRENGTH
DEEP-STYLE SAUCE PAN**

Constructed of extra-dent resistant 3004 aluminum alloy to take the abuse of daily foodservice operations, with double-thick top, edges and bottoms for maximum wear.
4304110.....8.5 qt. Sauce Pan; use Cover 4304190

WEAR-EVER ALUMINUM COVERS

These durable aluminum covers fit all Wear-Ever pots and pans.

- | | |
|-----------------------|-----------------------|
| 4304188.....8" Cover | 4304192.....12" Cover |
| 4304189.....9" Cover | 4304193.....13" Cover |
| 4304190.....10" Cover | 4304194.....14" Cover |
| 4304191.....11" Cover | 4304196.....16" Cover |



**WEAR-EVER PREMIER
SUPER-STRENGTH SAUCE POTS**

Made of extra dent-resistant 3004 aluminum alloy, with extra-thick bottoms and tops for heavy-duty use. All with sanitary, open bead and spot welded loop handles.
4304152.....14 qt. Sauce Potuse Cover 4304192
4304153.....20 qt. Sauce Potuse Cover 4304193



WEAR-EVER STANDARD SAUCE PANS

French-style pans with tapered sides are NSF listed and made of extra dent-resistant 3004 aluminum alloy.

- | |
|--|
| 4304341.....1.5 qt. Sauce Panuse Cover 43043412 |
| 4304342.....2.5 qt. Sauce Panuse Cover 43043422 |
| 4304343.....3.5 qt. Sauce Panuse Cover 43043432 |
| 4304344.....4.5 qt. Sauce Panuse Cover 43043442 |
| 4304345.....5.5 qt. Sauce Panuse Cover 43043452 |
| 4304347.....7 qt. Sauce Panuse Cover 43043472 |
| 4304348.....8.5 qt. Sauce Panuse Cover 43043482 |
| 4304350.....10 qt. Sauce Panuse Cover 43043502 |



WEAR-EVER STANDARD SAUCE POTS

Made of extra dent-resistant 3004 aluminum alloy, with uniform thickness, for years of dependable service. All with sanitary, open bead and spot welded loop handles.
433214 qt. Sauce Pot; use Cover 4304192

Pots & Pans



LACOR STAINLESS STEEL BRAZIER & PANS

Base of 18/10 stainless steel suitable for induction cooking. Non-heat conducting S/S handles. Sides curve gently into base to make stirring easy and cleaning simple.

- 4405003210.5 Qt. S/S Brazier & Lid
- 4405003315.5 Qt. S/S Brazier & Lid
- 4405003615 Qt. S/S Brazier & Lid
- 4405003723.25 Qt. S/S Brazier & Lid
- 4405004528.5 Qt. S/S Brazier & Lid
- 440502172.25 Qt. S/S Deep Sauce Pan
- 440502214.25 Qt. S/S Deep Sauce Pan
- 440502256.5 Qt. S/S Deep Sauce Pan
- 440512201-3/4 Qt. S/S Saute Pan
- 440512222-1/4 Qt. S/S Saute Pan
- 440512242-3/4 Qt. S/S Saute Pan

LODGE CAST IRON SKILLET

The best line of cast-iron cookware available. Not even the most expensive stainless steel or aluminum cookware can rival the even heating, the heat retention, the versatility and the value of lodge cast iron.

What other cookware can fry, saute, grill, roast, stew and bake at the expectation level of great chefs?

- 540600106.5" Cast Iron Skillet
- 540600118" Cast Iron Skillet
- 5406001210.25" Cast Iron Skillet
- 5406001312" Cast Iron Skillet

LODGE



WIRE ROUND FRY BASKETS

Heavy nickel-plated wire frame. Medium mesh wire basket with handle securely welded. Great for stove-top deep frying.

- 4040120111.5" Fry Basket
- 404010019.5" Fry Basket
- 40409018.5" Fry Basket



Halco

PRESSURE COOKER PARTS



- 90976Bakelite Top Handle
- 90977Bakelite Top Handle Screw
- 90965Control Valve
- 90972Geared Steam Gauge
- 90975Overpressure Plug
- 90954Clamp Bolt
- 90955Pin for Clamp Bolt
- 90964Bakelite Knob

STEEL FRY BOTTOM PAN

A stamped steel pan with steel upright and handle welded to pan. Rolled rim for extra strength. Keep fry bottom well-oiled when not in use to prevent corrosion.

- 404090.....9" Steel Fryer Pan
- Other sizes available for special order





Lincoln WEAR-EVER



WEAR-EVER STANDARD BAKE PAN

Natural finish extra dent-resistant type 3004 aluminum alloy, with straight sides and spot welded handles.
4304455.....18-1/2 x 12-1/2 x 2" Bake Pan



WEAR-EVER STANDARD BAKE PANS

Ideal for lasagna, roasts, meats, baked goods, casseroles and more. Made of extra dent-resistant type 3004 aluminum alloy, with sloping sides and spot-welded handles.
4304412.....9-3/4 x 13-3/4 x 3-1/4" Bake Pan
4304414.....10-7/8 x 16 x 2-1/4" Bake Pan
4304415.....11-7/8 x 17-3/4 x 2-1/4" Bake Pan



STANDARD STRENGTH FULL-SIZE BAKE & ROAST PAN

Will fit standard bun racks and refrigerator or freezer tray slides. Made of extra dent-resistant type 3004 aluminum alloy. NSF listed.
4305312117-3/4 x 25-1/4 x 2-1/4"

WEAR-EVER STANDARD STRENGTH STRAPPED ROAST PAN

Reinforced steel straps add strength and durability. NSF listed. Extra dent-resistant type 3004 aluminum alloy. Can be used as covers for 43044821 and 43044831 (below).
4304482.....16 x 20 x 4-1/2" Roast Pan
4304483.....18 x 24 x 4-1/2" Roast Pan



PREMIER SUPER-STRENGTH ROASTER

Tough enough to be standard equipment with the U.S. Army field range. For extremely heavy roasting needs.
4304493.....20-7/8 x 17-3/8 x 7" Roast Pan
4492.....21-1/8 x 17-5/8 x 2" Cover (special order)



WEAR-EVER STANDARD STRENGTH STRAPPED ROAST PAN W/LUGS

Strapped roast pans are ideal for high-volume use. they always retain their rigidity, in and out of the oven.. NSF listed. Extra dent-resistant type 3004 aluminum alloy.
4304482116 x 20 x 4-1/2" Roast Pan
4304483118 x 24 x 4-1/2" Roast Pan

Lincoln WEAR-EVER



DURA WARE BAKE & ROAST PAN

This 21 qt. roaster's extra large, heavy duty size is capable of holding multiple roasts, turkeys or hams. Made of 12 ga. aluminum, with drop handles. Reinforced rolled edge for added strength.

4040303825-3/4 x 17-3/4 x 3-1/2"



ALUMINUM MUFFIN & CUP CAKE PANS

Pans are heavy-duty construction with cups permanently seamed in the frame.

4049500612 Cups, 10-3/4 x 14-1/8"

4049500724 Cups, 20-5/8 x 14-1/8"



BREAD PANS

Aluminum 4-strap 10 x 5" open-top bread pan.

40495003overall 10-23/32 x 26"



WEAR-EVER PROFESSIONAL SHEET & BUN PANS

Preferred in kitchens because of their excellent strength and durability. Made of extra dent-resistant type 3004 aluminum alloy with sanitary open bead. Full and half-size pans are NSF listed.

43090021Natural Finish Perf. Full-Size, 12 ga. Heavy Duty, 18 x 26"

4309001Natural Finish Full-Size, 16. ga. Medium Duty, 18 x 26"

4309002Natural Finish Full-Size, 18. ga. Light Duty, 18 x 26"

4305303Natural Finish Half-Size, 18. ga. Light Duty, 12 x 18"

4305220Natural Finish Quarter-Size, 16. ga. Medium Duty, 9 x 12"

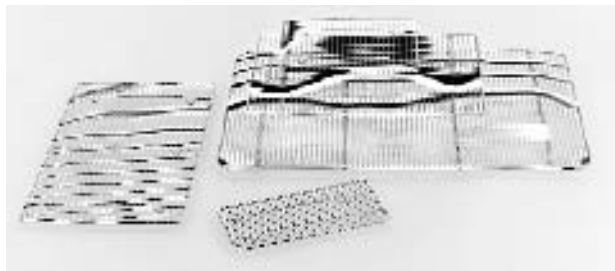

SHEET PAN & ICING GRATES

65010303Full Sheet Pan Grate, 17 x 25"

65010301Half Sheet Pan Grate, 16-1/2 x 12 x 3/4"

65010300Icing Grate, 16-1/2 x 24-1/2 x 1"

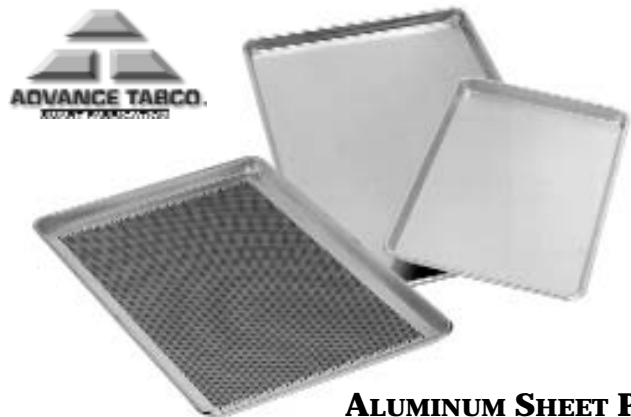

ALUMINUM SHEET PANS

Rugged and durable sheet pans, perfect for everyday use..

40400100Full-Size, 16 ga. Heavy Duty, 18 x 26"

40400101Full-Size, 18 ga. Standard Duty, 18 x 26"

43053032Half-Size, 18 ga. Standard Duty, 13 x 18"



WEAR-EVER HOUSEHOLD WEIGHT UTENSILS

Small jobs deserve professional treatment, so we stock Household Weight utensils for professional who needs to prepare smaller portions of specialty items.



BISCUIT & CAKE PAN
Perfect for baking cakes, biscuits and baked apples. Household weight.
43027661 ...12-3/4 x 9 x 2"



BREAD & MEAT LOAF PANS
Seamless loaf pans with easy-clean corners - perfect for frozen desserts, nut breads, meat loaf, and pound cake. Household weight.
430277119-1/4 x 5-1/4 x 2-3/4"
4302773111-1/4 x 4-1/2 x 2-3/4"



LIGHT WEIGHT PIE PANS
Anodized finish absorbs and spreads heat evenly for better crusts and fillings.
430284419" dia.
4302845110" dia.



MUFFIN & CUPCAKE PAN
Perfect for preparation of smaller portions of muffins, cupcakes and potato puffs. With 12, 2-1/2" cups. Household weight.
4302756112-3/4 x 9-3/4"

Lincoln WEAR-EVER



NO-STICK BAKE PAN
Easy-to-clean bake pan, with DuPont SilverStone® coating. Household weight.
4302672113-1/4 x 9-1/4 x 2-1/4"



WEAR-EVER PROFESSIONAL WEIGHT PIE PAN
Natural finish for even baking.
430583419" dia.

PROFESSIONAL LAYER CAKE PANS
The pans are aluminized steel glazed with rolled rims and rounded edges for easier release, cleaning and stacking. Professional weight.
54001010 " dia. 1" deep



WEAR-EVER PROFESSIONAL WEIGHT LAYER CAKE PAN
Seamless and strong aluminum layer cake pans with a special non-warping feature.
43053479" dia. Cake Pan
S5347*9" dia. Non-Stick Cake Pan
*special order





VOLLRATH SUPER PAN II® STAINLESS STEEL STEAM TABLE PANS

Made in the U.S.A. for consistent quality, of industry-standard 18-8, type 304 Stainless Steel, these pans can go from freezer to oven to serving line without re-panning your food. With reinforced corners, anti-jamming design, coved interior corners, and flat edges for a tight fit to keep temperatures even. 22 Gauge, NSF listed.

FULL-SIZE PANS

460100102.5" Deep Perf
 460100114" Deep Perf
 460100126" Deep Perf
 470310602.5" Deep
 470310614" Deep
 470310626" Deep
 46010005Hinged Flat Cover
 46010006Dome Cover
 46010007Hinged Dome Cover

TWO-THIRD-SIZE PANS

460100802.5" Deep
 460100814" Deep
 460100826" Deep
 46010083Solid Cover

HALF-SIZE

470310631.25" Deep
 470310642.5" Deep
 470310654" Deep
 470310666" Deep
 470310804" Deep Perf Pan

HALF-SIZE LONG

460100691.25" Deep
 460100702.5" Deep
 460100714" Deep
 460100726" Deep
 46010073Flat Cover

ONE-THIRD-SIZE

470310682.5" Deep
 470310694" Deep
 470310706" Deep
 75130*Flat Cover

ONE-FOURTH SIZE

470310722.5" Deep
 470310734" Deep
 470310746" Deep
 75140*Flat Cover

ONE-SIXTH SIZE

470310762.5" Deep
 470310774" Deep
 470310786" Deep
 75160*Flat Cover

* special order





CARLISLE
Food Service Products

DURAPAN™ STAINLESS STEEL STEAM TABLE PANS

Non-jamming 18-8 stainless steel construction with double-reinforced edges and unique impact-resistant edge so pans hold their shape under rough conditions. Maintain tight seal; with spoonable bottom design. 22 gauge, NSF listed.

FULL-SIZE PANS

- 45002000 . . .2.5" Deep
- 45002004 . . .4" Deep
- 45002006 . . .6" Deep
- 45002010 . . .Slotted Cover
- 45002011 . . .Solid Cover

HALF-SIZE PANS

- 45001202 . . .2.5" Deep
- 47031079 . . .2.5" Deep Perf
- 45001204 . . .4" Deep
- 45001206 . . .6" Deep
- 45001210 . . .Slotted Cover
- 45001211 . . .Solid Cover

ONE-THIRD SIZE PANS

- 45001302 . . .2.5" Deep
- 45001304 . . .4" Deep
- 45001306 . . .6" Deep
- 45001310 . . .Slotted Cover
- 45001311 . . .Solid Cover

SPILLAGE PANS

- 404552Aluminum Spillage Pan/Fabrication
- 404576Aluminum Spillage Pan
- 404676S/S Spillage Pan

ONE-FOURTH SIZE PANS

- 450014022" Deep Pan
- 450014044" Deep Pan
- 450014066" Deep Pan
- 45001410Slotted Cover
- 45001411Solid Cover

ONE-SIXTH-SIZE PANS

- 450016022.5" Deep
- 450016044" Deep
- 450016066" Deep
- 45001610Slotted Cover
- 45001611Solid Cover

ONE-NINTH-SIZE PANS

- 460100602.5" Deep
- 460100614" Deep
- 46010062Slotted Cover
- 45001911Solid Cover



ADAPTER BAR

450731012" Adapter Bar



TELESCOPING COVER

4042000Full Size



CAMWEAR DRAIN SHELF

Support product and promote drainage. Clear polycarbonate.

- 50502090Drain Shelf for Full
- 50502091 Drain Shelf for 1/2
- 50502092Drain Shelf for 1/3
- 50502093Drain Shelf for 1/4
- 50502094Drain Shelf for 1/6



FOOTED PAN GRATES

Chrome plated grates keep food raised from the bottom of pans.

- 65010302Full Size Pan Grate 10-1/2 x 18-1/2 x 3/4"
- 65010304Full Size Pan Grate 10-1/2 x 18-1/2 x 1"
- 65010307Half Size Pan Grate 8 x10"



CAMBRO

FULL-SIZE PANS

- 50502512Amber 2-1/2" Deep
- 50502514Amber 4" Deep
- 50502516Amber 6" Deep
- 50502080Amber Notched Cover w/Handle
- 50502101Clear 2-1/2" Deep
- 50502102Black 2-1/2" Deep
- 50502103Clear 4" Deep
- 50502104Black 4" Deep
- 50502105Clear 6" Deep
- 50502106Black 6" Deep
- 50502107Clear Flat Cover
- 50502108White Seal Cover
- 50502085Clear Grip Lid
- 50502095Clear Notched Cover w/Handle
- 50502041Translucent 4" Deep
- 50502042Translucent 6" Deep
- 50502059Translucent Cover

HALF-SIZE PANS

- 50502522Amber 2-1/2" Deep
- 50502524Amber 4" Deep
- 50502526Amber 6" Deep
- 50502081Amber Cover w/Handle
- 50502109Clear 2-1/2" Deep
- 50502110Black 12-1/2" Deep
- 50502111Clear 4" Deep
- 50502112Black 4" Deep
- 50502113Clear 6" Deep
- 50502114Black 6" Deep
- 50502115Clear Flat Cover
- 50502116White Seal Cover
- 50502086Clear Grip Lid
- 50502096Clear Notched Cover w/Handle
- 50502136Long Food Pan Flat Cover
- 50502044Translucent 4" Deep
- 50502045Translucent 6" Deep
- 50502061Translucent Cover

ONE-THIRD-SIZE PANS

- 50502532Amber 2-1/2" Deep
- 50502534Amber 4" Deep
- 50502536Amber 6" Deep
- 50502082Amber Notched Cover w/Handle
- 50502117Clear 2-1/2" Deep
- 50502118Black 2-1/2" Deep
- 50502119Clear 4" Deep
- 50502120Black 4" Deep
- 50502121Clear 6" Deep
- 50502122Black 6" Deep
- 50502123Clear Flat Cover
- 50502124White Seal Cover
- 50502097Clear Notched Cover w/Handle
- 50502087Clear Clear Grip Lid
- 50502047Translucent 4" Deep
- 50502048Translucent 6" Deep
- 50502063Translucent Cover

CAMWEAR® FOOD PANS

Our Clear, Black, White and translucent pans have a wide temperature range, -40°F to +210°F, while our Amber pans are microwave and steam-table safe, with a wider temperature range, -40°F to +375°F. Economical Translucent polypropylene pans have a range of -40°F to +160°F. Camwear pans are made of virtually unbreakable polycarbonate and are quiet, easy-to-touch, non-sticking, and won't bend or dent.

ONE-FOURTH SIZE PANS

- 50502542Amber 2-1/2" Deep
- 50502544Amber 4" Deep
- 50502546Amber 6" Deep
- 50502083Amber Notched Cover w/Handle
- 50502153Clear 2-1/2" Deep
- 50502154Black 2-1/2" Deep
- 50502155Clear 4" Deep
- 50502156Black 4" Deep
- 50502157Clear 6" Deep
- 50502158Black 6" Deep
- 50502098Clear Notched Cover w/Handle
- 50502159Clear Flat Cover
- 50502152White Seal Cover
- 50502050Translucent 4" Deep
- 50502051Translucent 6" Deep
- 50502065Translucent Cover

ONE-SIXTH-SIZE PANS

- 50502562Amber 2-1/2" Deep
- 50502564Amber 4" Deep
- 50502566Amber 6" Deep
- 50502125Clear 2-1/2" Deep
- 50502126Black 2-1/2" Deep
- 50502127Clear 4" Deep
- 50502128Black 4" Deep
- 50502129Clear 6" Deep
- 50502130Black 6" Deep
- 50502131Clear Flat Cover
- 50502132White Seal Cover
- 50502099Clear Notched Cover w/Handle
- 50502053Translucent 4" Deep
- 50502054Translucent 6" Deep
- 50502067Translucent Cover

ONE-NINTH-SIZE PANS

- 50502170Clear 2-1/2" Deep
- 50502134Black 2-1/2" Deep
- 50502171Clear 4" Deep
- 50502135Black 4" Deep
- 50502172Clear Flat Cover
- 50502056Translucent 4" Deep
- 50502069Translucent Cover



STAINLESS STEEL BAINS MARIE

You can never have enough storage and serving containers. These 18-8 type 304 stainless steel containers are perfect for rapid heating and cooling, and clean up quickly. NSF listed.

- | | |
|------------------------|------------------------------|
| 450000011.25 Qt. | 450100011.25 Qt. Cover |
| 450000022 Qt. | 450100022 Qt Cover |
| 450000033.5 Qt. | 450100033.5 Qt Cover |
| 450000044.25 Qt. | 450100044.25 Qt Cover |
| 450000066 Qt. | 450100066 Qt. Cover |
| 450000088.25 Qt. | 450100088 Qt. Cover |
| 4500001212 Qt. | 4501001212 Qt. Cover |



STAINLESS STEEL VEGETABLE INSETS

Our shouldered round insets are perfect for use in round steam table openings and soup merchandisers. These 18-8 type 304 stainless steel containers are perfect for rapid heating and cooling, and clean up quickly. NSF listed.

- 450000052.5 Qt. Inset, 5" dia.
- 450000164 Qt. Inset, 6-1/2" dia.
- 450000187 Qt. Inset, 8-1/2" dia.
- 4500001011 Qt. Inset, 10-1/2" dia.
- 450100052.5 Qt. Inset Cover, 5" dia.
- 450110064 Qt. Inset Cover, 6-1/2" dia.
- 450110087.25 Qt. Inset Cover, 8-1/2" dia.
- 470474887.25 Qt. Hinged Inset Cover, 8-1/2" dia.
- 4501001011 Qt. Inset Cover, 8-1/2" dia.
- 4704749011 Qt. Hinged Inset Cover, 10-1/2" dia.



ADAPTER PLATES

- 46010094.....#32 Panel for 2 each 8-1/2" Inserts
- special order.....#31 Panel for 3 each 6-1/2" Inserts

Kitchen Supplies

FINE & COARSE CHINA CAPS

Sturdy 18-8 stainless steel with a perforated metal body. One piece handle rests solidly on rim of pan. The grooved handle design adds to strength, while frame-style handle dissipates heat.

- 4041709.....9" Fine China Cap
- 4041809.....9" Coarse China Cap
- 4041710.....10" Fine China Cap
- 4041712.....12" Fine China Cap
- 4041812.....12" Coarse China Cap



BOUILLON STRAINER

Tin-plated with extra-fine mesh. Pan hook provides stability while straining liquids.

- 4041711.....8" Bouillon Strainer



STAINLESS STEEL SINGLE MESH STRAINER

Double pan hooks and flat bottom handles. Stainless steel makes these strainers more durable and easier to clean.

- 530102014.75" Medium Strainer
- 530102026.375" Medium Strainer
- 530102038" Medium Strainer
- 5301020410.125" Medium Strainer



STAINLESS STEEL DOUBLE MESH STRAINER

Double pan hooks and flat bottom handles. Stainless steel makes these strainers more durable and easier to clean.

- 530102066.375" Med. Double Mesh Strainer
- 530102078" Med. Double Mesh Strainer
- 5301020810.125" Fine Strainer
- 5301020910.125" Reinforced Strainer
- 5301021012" Reinforced Strainer



WEAR-EVER CHINA CAP STRAINER

Fitted with 2 hooks for hanging over the edge of a stock pot - the top hook allows strainer to sit level with pan when using wooden roller, the lower hook leans strainer against side of pan during straining to eliminate back splash.



- 4304700..... 5.5 Qt.
- 4700R.....Wooden Roller - special order



FINE MESH BOUILLON STRAINER

Fine mesh, 18-10 steel.

- 555348.....8" Bouillon Strainer
- 555349.....9-1/2" Bouillon Strainer



**BRUSHED FINISH & NON-SKID
S/S MIXING BOWLS**

These bowls are dishwasher safe stainless steel. Non-skid bowls feature a non-skid coating bonded to outside bottom of bowls to keep them in place and stable while you work.

- 650871.....4 Qt. S/S
- 650872.....6 Qt. S/S
- 650873.....8 Qt. S/S
- 6508721.....6 Qt. Non-Skid S/S
- 6508731.....8 Qt. Non-Skid S/S



STAINLESS STEEL MIXING BOWLS

Vollrath's imported bowl are made of bright, mirror-finish 18-0 stainless steel. They clean easily and are dishwasher safe.

- | | |
|---------------------|--------------------|
| 4503501.....3/4 Qt. | 4503508.....8 Qt. |
| 4503502.....1.5 Qt. | 4503513.....13 Qt. |
| 4503503.....3 Qt. | 4503516.....16 Qt. |
| 4503504.....4 Qt. | 4503510.....20 Qt. |
| 4503505.....5 Qt. | |



**STANDARD WEIGHT
ALUMINUM COLANDER**

Seamless satin-finish aluminum with rolled top edge for extra strength. Sturdy handles are securely riveted.

- 4040301111 Qt.
- 4040301216 Qt.



**PROFESSIONAL WEIGHT
ALUMINUM COLANDERS**

Perforated with 3/16" holes, the bowl is fitted to the base with 8 spot welds. Satin finish aluminum.

- 4304611.....11 Qt.
- 4304616.....16 Qt.



**HOUSEHOLD WEIGHT
ALUMINUM COLANDER**

Satin finish anodized aluminum is resistant to stains. Fitted with sturdy feet.

- 430312515 Qt.



**PROGRESSIVE PLASTIC
COLANDER**

Perfect for all draining needs, with easy-grip handles and feet for stability

- 50000011PSC-11 11-3/8"



STAINLESS STEEL COLANDER

Mirror finish stainless steel with base.

- 404060013 Qt. S/S
- 404060025 Qt. S/S
- 404060038 Qt. S/S
- 4040304713 Qt. S/S

Kitchen Supplies



STAINLESS STEEL FLOUR SIFTER

Sifter is 18-8 stainless steel with a polished body, handle and 16 mesh (squares per inch) screen. The beater is chrome plated with wire reinforcement on the bottom. 8 cup capacity.

40423 lb. Rotary Flour Sifter



STAINLESS STEEL RIM SIEVE

16 mesh wire with two cross-bar reinforcers. 4041105016" dia.



STAINLESS STEEL SKIMMERS

Brightly polished S/S skimmer is easy to clean. Long, hooked handle serves as a pot rest.

450814.5" Round Skimmer

450866" Round Skimmer



SQUARE SKIMMER

One-piece handle is low heat transferring. Fine wire mesh.

5409975 x 6" square



ROUND MESH SKIMMERS

Rigid, hooked handle is designed for low heat transfer. Nickel-plated square mesh.

55513077" dia.

55513088" dia.

55513099" dia.



ALUMINUM MEASURING CUPS

Set of 4 aluminum short handle cups, including measures for 1 cup, 1/2 cup, 1/3 cup and 1/4 cup. Can be used on stove top for heating ingredients.

54077Aluminum



MEASURING CUP SET

Set of 4 S/S measuring cups with wire handles.

65010864Stainless Steel



MEASURING CUP SET

Cup sizes with graduated measures for 1 cup, 1/2 cup, 1/3 cup and 1/4 cup.

555136Stainless Steel



S/S MEASURE SPOON

S/S with contoured grip handles. 1/4 tsp., 1/2 tsp., 1 tsp., & 1 Tbsp.

50003494



MEASURING SPOON SETS

Stamped with U.S. standard capacities; 1/4, 1/3, 1/2, 1 teaspoon, and 1 tablespoon.

555130Square Aluminum

5402314Round Aluminum





ECONOMY LIQUID MEASURES

Heavy-duty aluminum with seamless construction, large, riveted handles, and capacity markings. Designed for no-spill pouring.

- 404040001/2 Qt.
- 404040011 Qt.
- 404040022 Qt.
- 404040034 Qt.



CAMWEAR MEASURING CUPS

These color-coded crystal-clear measuring cups make measuring easier. Molded-in graduations are blue on one side for metric and red on the other side for standard American measures. Virtually indestructible polycarbonate.

- 58032101 Cup (Dry Measure)
- 58032151 Pt.
- 58032161 Qt.
- 58032172 Qt.
- 58032184 Qt.

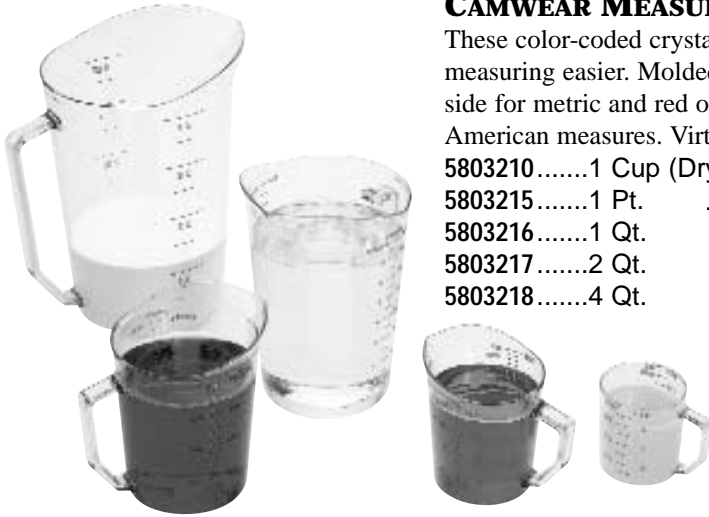

WEAR-EVER PROFESSIONAL ALUMINUM MEASURES

Made of extra dent-resistant aluminum alloy with silver-glow finish. Concave bottom eliminates tipping. NSF listed.

- 43053501/2 Pt.
- 43052601 Pt.
- 43052611 Qt.
- 43052622 Qt.
- 43052644 Qt.



STAINLESS STEEL DREDGE

Polished stainless steel with with universal holes, perfect for flour, sugar, etc.

- 5550050110 oz. w/Handle
- 5550050010 oz. no Handle



ALUMINUM DREDGES

For all ground and granular spices, these dredges feature seamless construction and wide screw tops for easy filling.

- 4305062Dredge w/Handle
- 4305063Dredge no Handle



FLUTED PLASTIC SHAKERS

These 12 oz. lexan shakers are practically indestructible. With straight-side fluted design, they are perfect for pizza spices, sugar and cheese.

- A. 55500476w/Cheese Lid
- B. 55500477w/Dredge Lid



CAMWEAR SHAKERS

You should use these in your dining area, they look sp good. Made of clear lexan so you can easily see the contents. Virtually indestructible. 10 oz.

- 50502133w/ Salt & Pepper Lid
- 50502140w/ Cheese Lid
- 50502141Replacement Cheese Lid (yellow)



WIDE RIM PIZZA PANS

Made of 18 gauge, 1 mm. aluminum with wide, rolled edge.

555004448"	5550045413"
555004469"	5550045614"
5550044810"	5550045815"
5550045011"	5550045916"
5550045212"	5550045718"



PIZZA SCREEN RACK

Made of rigid chrome plated steel rods, this rack holds up to 96 screens, from 6" to 28" diameter screens.

55501804 . .4-Slot Screen Rack



HEAVY DUTY ALUMINUM PIZZA SCREENS

Pizza screens allow a more evenly baked crust by allowing heated air to circulate beneath the crust.

555004678"	5550046314"
5550046810"	5550046415"
55500469*11"	5550046516"
5550046112"	5550046618"
55500462*13"	

* special order

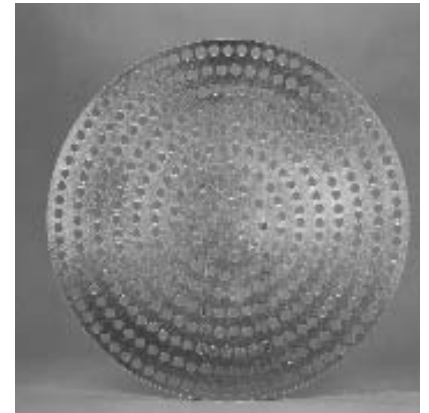

PERFORATED COOKING DISKS

Produce more evenly baked crust by allowing air to circulate beneath crust.

5550048412" Dia.

5550048614" Dia.

5550048816" Dia.

5550049018" Dia.

PIZZA PAN RACK

Sturdy square base and heavy chrome-plated steel rod construction. Each shelf can hold up to 6 pounds.

5551902915-Shelf, for 1.25" pans

5551903011-Shelf, for 2.25" pans



PIZZA DOUGH BOXES

These rigid, white, polycarbonate boxes save time, labor and money by increasing the storage life of your pizza dough.

They stack securely, and are reinforced on all sides, with rounded edges for safety. 18 x 26" outside dimensions, 15-1/2 x 23-1/2" inside dimensions.

505022053" deep Box

505022066" deep Box

50502207Cover





PIZZA STAND

Makes for added room on table, made of heavy chrome plated steel rod.
555190039 x 8 x 7"h.



HARDWOOD PIZZA PEEL

Made of seasoned hardwood.
Never soak wooden peels in water.
5550004312"x14" Blade
5550004416"x18" Blade



PIZZA PEELS

Hardwood handles with aluminum blades and rugged cast aluminum ferrules.

55500439Extra Large 16" x 18" Blade; 39 1/2" long
5551428Large 14"x16" Blade, 28" Long
55500440Medium 12 x 14" Blade, 26" long
55500441Medium 12 x 14" Blade, 35 1/2" long



PIZZA KNIVES

Safe, two-handed pizza knives. Stainless blades.
55500471Two Handle Pizza Knife
5550047220 20" Rockin' Pizza Knife



BUBBLE POPPER

All aluminum, 31" long.
55500493



SANI-SAFE SERVER

Stainless steel blade, sanitary plastic handle.
555165036 x 5" Blade



PIZZA CUTTERS

Sanitary stainless blades with rust-proof guards and finished wooden handles.
555004422.5" Blade
555004434" Blade



SANI-SAFE PIZZA CUTTER

Stainless steel blade, sanitary plastic handle. 4" Blade.
55518023Cutter
55518010Rrp'l. Blade



CHEESE & SPICE JARS

Clear unbreakable lexan w/stainless lids.
55500475w/Perforated Lid
55500474w/Slotted Lid



DOUGH SCRAPER

Wood handle and S/S blade.
555240004 x 6" blade
5401835 x 7" blade

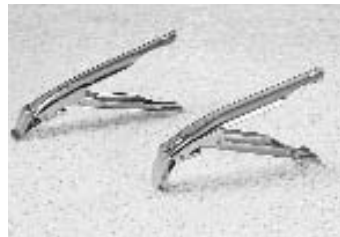

PAN GRIPPERS

Self-locking design.
55500491Shallow
55500492 Deep



PIZZA DELIVERY BAGS

Heavily insulated pouch with velcro closures is ideal for transporting hot pizzas.
5550014020"x20"

Baking Supplies



PLASTIC FUNNEL

White, one-piece seamless.
530935.....16 oz. Funnel



STAINLESS STEEL FUNNEL

Mirror-finish stainless steel.
470847701 Qt. Funnel



PLASTIC SCOOP

One-piece, durable plastic, flat bottom.
530183382 oz.

PIE MARKERS

Reliable, consistent sizing eliminates waste and increases profitability. Cast aluminum with polished finish.

54084066-Cut

54084088-Cut

5408566-Cut 856

5408577-Cut 857

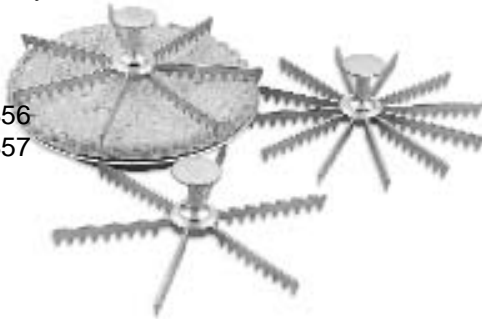

WOOD ROLLING PINS

530526515"

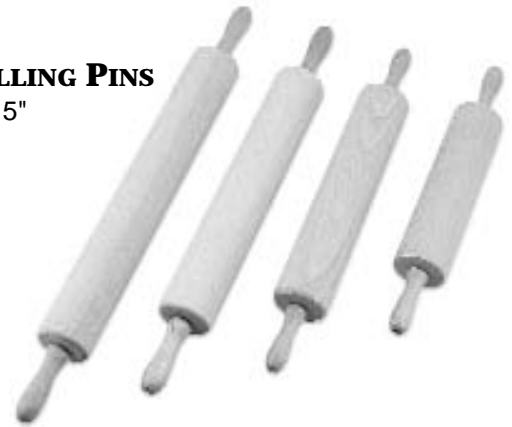

ROUND COOKIE CUTTER SET

Set of 16 tinned cookie cutters.
530138



DONUT CUTTERS

Solid construction for heavy commercial use;
1" center tube.
55541033" Aluminum

ALUMINUM SCOOPS

Polished, die-cast aluminum.

530103985 oz.

5301039912 oz.

5301040024 oz.

5301040138 oz.

5301040258 oz.

5301040385 oz.



WEAR-EVER ALUMINUM SCOOPS

Die-cast aluminum with integral handles, they are strong, durable and NSF listed.

430528018 oz. Scoop

430528124 oz. Scoop

430528232 oz. Scoop

430528348 oz. Scoop



DECORATING COMB

Quick and easy way to decorate cakes and pastries. made of aluminum.
5551446

PLASTIC COATED DECORATING BAGS

Great for piping foods. Easy to clean, economical, and won't slip from your hand. made of print cloth, lined with polyethylene; with rust-proof eyes.

- 555460.....10"
- 555462.....12"
- 555464.....14"
- 555466.....16"
- 555468.....18"
- 555471.....21"
- 555474.....24"



8-PIECE DECORATING SET

With a standard coupler attached to a 10" flex bag, 6 standard tubes.
55502432



CAKE ORNAMENTOR SET

With a plastic coupler attached to a 10" plastic-coated decorating bag and 12 assorted seamless decorating tubes.
55502431



DECORATING TUBE SETS

Sets including writing, star, leaf, rose, basket-weave, and other flower tubes, in a hinged storage box.
555782.....29-Piece Set
555783.....55-Piece Set



LARGE PASTRY TUBES

Seamless stainless steel

- | | |
|-------------------------|-----------------------------------|
| 55502409800 Plain | 55502420840 Closed Star |
| 55502410801 Plain | 55502421841 Closed Star |
| 55502411802 Plain | 55502422842 Closed Star |
| 55502412803 Plain | 55502423843 Closed Star |
| 55502413804 Plain | 55502424844 Closed Star |
| 55502414805 Plain | 55502425845 Closed Star |
| 55502415806 Plain | 55502426846 Closed Star |
| 55502416807 Plain | 55502427847 Closed Star |
| 55502417808 Plain | 55502428848 Closed Star |
| 55502418809 Plain | 55502429849 Closed Star |
| 55502408Standard* | 55502430400 Delrin Coupling |

*Standard tube available in stock, #1 - 105: please specify

Baking Supplies



MATFER FLUTED TART PAN

555718234-3/4 x 3/4"



NON-STICK FLUTED TART PANS

5557328110-1/4 x 1"

5557328511-7/8 x 1"



MATFER PASTRY TIPS

55580068A8 Star 1/8"

55580088B8 Star 5/32"

55580108C8 Star 9/32"

55580128D8 Star 10/32"

55580148E8 Star 11/32"



EXOCET BAKING MAT

5558450618"x26"

5558450713"x18"



BAGEL BOARD

Perfect for proofing bagels.
Heavy duty plastic, easy to clean,
will not rot or mildew.

606182618 x 26 x 5/16"



BELSHAW PANCAKE DISPENSER

Exact portion control for greater profits.
Eight dial settings for 1/2 to 3 ounce
deposits- dollar size to king size. NSF
listed, disassembles and cleans up easily.
5.5 lb capacity



MANDARIN WOKS

Hand hammered Mandarin woks with riveted iron handles. Cold forged, ideal for induction, gas or electric ranges.

- 4048713.....13" Wok
- 4048715..... 15" Wok



CANTONESE WOKS

The finest Cantonese woks available. Cold forged, perfect shape: handles will not break. Other sizes available special order.

- 4048718.....18" Wok
- 4048722.....22" Wok
- 4048724.....24" Wok
- 4048728.....28" Wok



55500056

CHINESE SHOVEL

Long stainless steel turner with wood handle

55500054S/S Turner

CHINESE SOLID LADLES

Stainless steel bowl and ferrule with wooden handle

555000569 oz.



WOK & GONG BRUSHES

Perfect for cleaning woks and electric griddles.

- 808113208-3/4"
- 8084401212"

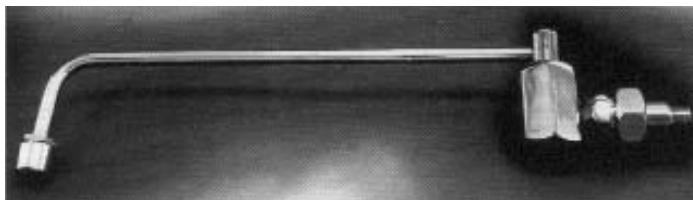

SWING FAUCET

Fits 3/8" IPS fittings, includes aerator. special order

CLEAVERS

Wood handle and high-carbon or stainless steel blades.

- A 555080607" High Carbon Steel
- B 555080106" High Carbon Steel
- C 555080408 x 3-1/4" S/S
- D 555080208 x 3-1/4" High Carbon Steel



A



B



C & D

For more of our Asian foodservice products, see the Cutlery and Equipment sections.



BEST LIGHT FRENCH WHIP

This balanced whip is perfect for small mixing needs, with its small handle and whip head. metal handle.
555340498"



BEST MAYONNAISE WHIP

Big, strong whip for blending, stirring and mixing of large batches. Flexible wires mix more efficiently than rod or paddle mixers.
5553406036"

BEST WOOD HANDLE FRENCH WHIPS

Hi-tensile strength stainless steel wires firmly attached to lacquered wood handles. The wood handle provides a secure grip, and is sealed for sanitary, dishwasher-safe cleaning.

- 5553405010"
- 5553405112"
- 5553405214"
- 5553405316"
- 5553405418"
- 5553405520"
- 5553405624"



CONICAL WHIPS

New shape makes sauces quicker with less waste. Quickly deglaze flat bottom pans. Reach ingredients in corners. Commercial stainless steel construction.

- 5551371043 ..13 3/4"
- 5551371044 ..15 3/4"
- 5551371045 ..19 3/4"

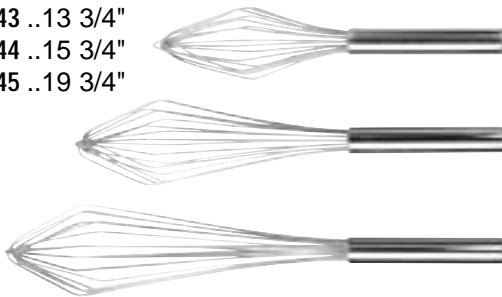

MATFER FRENCH WHIPS WITH EXOGLASS HANDLES

Handles heat resistant to 430°F, dishwasher safe.

- 5550826210"
- 5550826312"
- 5550826413.75"
- 5550826515.75"
- 5550826617.75"
- 5550826719.75"



FRENCH WHIPS

Thicker wires for mixing heavy products. Made of 18-8 S/S. Wires and uniform handle are securely welded and sealed to eliminate any dirt-catching seams.

- 450321010"
- 450321212"
- 450321414"
- 450321616"
- 450321818"
- 450322020"
- 450322424"

PIANO WHIPS

Fine wire construction for blending thin foods and consommés. Wires and uniform handle are securely welded and sealed to eliminate any dirt-catching seams.

- 450331010"
- 450331212"
- 450331414"
- 450331616"
- 450331818"





KOOL-TOUCH LADLES

Color codes portion-control ladles take the guesswork out of size selection. 18-8 stainless steel ladles with coated handles that stay comfortable up to 180°F.

- 470583444 oz. Gray
- 470583556 oz. Teal
- 470583668 oz. Orange



ONE-PIECE LADLES

Sturdy mirror-finish stainless steel. One-piece construction is sturdier and more sanitary.

- 45037911 oz.
- 45037922 oz.
- 45037933 oz.
- 45037944 oz.
- 45037966 oz.
- 45037988 oz.
- 450379912 oz.



STAINLESS STEEL TWO-PIECE LADLES

Sturdy mirror-finish stainless steel.

- 45038001/2 oz.
- 45038011 oz.
- 450380111.5 oz.
- 45038022 oz.
- 45038033 oz.
- 45038044 oz.
- 45038055 oz.
- 45038066 oz.
- 45038088 oz.
- 450381212 oz.

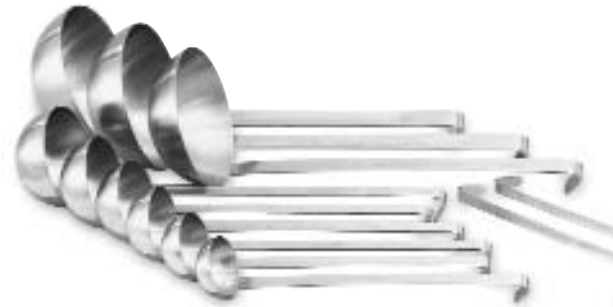

GOURMET LADLE

One-piece stainless steel construction, 5" long.
555004271/2 oz.



STAINLESS SYRUP LADLE

Ideal for syrup, fudge, fruit & gravy, 7" handle.
555004291.5 oz.



DIPPER

Stainless steel with 12" hooked handle, with marked gradations
4501771 qt.



DIPWELL

The running water action, as required by the US Dept of Health, removes food residue, therefore the bacteria which forms on the residue. 10"L x 6"H x 3"W.

- 55511703Standard Dipwell
- 55511702Installation Kit





STOCKEL ICE CREAM/FOOD DISHERS

Our best quality dishers, made from solid brass, then chrome-plated for durability. They have a round bowl, with capacity stamped on blade. Twin grip handle operates the S/S spring for easy portion release. Works for right or left handed use.

53010300Size 8	53010306Size 30
53010301Size 10	53010307Size 40
53010302Size 12	53010308Size 50
53010303Size 16	53010309Size 60
53010304Size 20	53010310Size 70
53010305Size 24	53010311Size 100



ICE CREAM DISHERS

Stainless steel bowls and color-coded sure-grip handles with heavy-duty spring action.

47047139Size 6	47047144Size 20
47047140Size 8	47047145Size 24
47047141Size 10	47047146Size 30
47047142Size 12	47047147Size 40
47047143Size 16	



SQUEEZE DISHERS

Constructed entirely of type 304 stainless steel. Blade extends beyond bowl to prevent sticking. Fits right or left hand. NSF listed.

47047150Size 8	47047156Size 30
47047151Size 10	47047157Size 40
47047152Size 12	47047158Size 50
47047153Size 16	47047159Size 60
47047154Size 20	47047160Size 70
47047155Size 24	47047161Size 100



PORTION SERVERS

One-piece stainless steel with plastic handles color-coded to capacity.

45038402 oz. Red	45038454 oz. Perf Green
45038412 oz. Perf Red	45038466 oz. Black
45038423 oz. Ivory	45038476 oz. Perf Black
45038433 oz. Perf Ivory	45038488 oz. Blue
45038444 oz. Green	45038498 oz. Perf Blue



ICE CREAM SPADE

One-piece stainless steel blade with plastic handle.
555289.25"



ALUMINUM ICE CREAM DIPPER

Polished aluminum, with no moving parts to break. Releases portions instantly, defrosts automatically.

555012Size 12	55520Size 20
55516Size 16	ICD-24Size 24 (special order)



BASTING & SERVING SPOONS

One-piece stainless steel. Heavy weight

- 4500011011" Solid
- 4500111011" Perforated
- 4500211011" Slotted
- 4500013013" Solid
- 4500113013" Perforated
- 4500213013" Slotted
- 4500015015" Solid
- 4500115015" Perforated
- 4500215015" Slotted



HOOKED HANDLE SPOON

Heavy gauge 18-8 stainless steel with long, hooked handle.

- 4500021021" Solid Serving Spoon
- 6018015" Fork (special order)
- 6019021" Fork (special order)



PLASTIC HANDLE SPOONS

Stainless steel serving spoons with Bakelite® handles.

- 4500313013" Solid
- 4500313113" Perf.
- 4500313213" Slotted



**MATFER EXOGLASS
BASTING SPOONS**

Heat resistant to 430°F,
dishwasher safe.

- 5556543015"
- 5556543111-7/8"
- 5556542917-3/4"

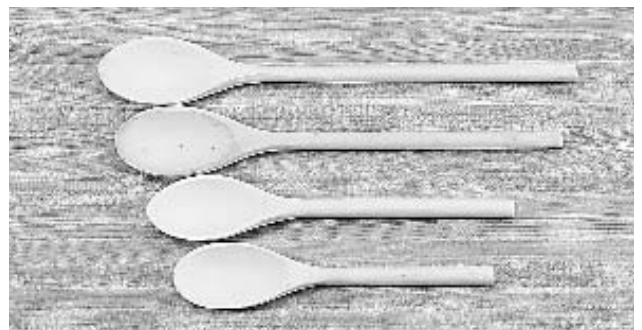

HEAVY WOODEN SPOONS

Heavy weight hardwood, professional quality.

- 540831212"
- 540831818"
- 540842424"



Kitchen Supplies



KOOL-TOUCH COLOR-CODED UTILITY TONGS

Provide a cool, comfortable grip, and avoid cross-contamination with color coded handles.

- | | |
|----------------------------|---------------------------|
| 4704780910 ..9-1/2" S/S | 4704780970 ..9-1/2" Green |
| 4704780920 ..9-1/2" Black | 4704781230 ..12" Blue |
| 4704780930 ..9-1/2" Blue | 4704781240 ..12" Red |
| 4704780940 ..9-1/2" Red | 4704781250 ..12" Yellow |
| 4704780950 ..9-1/2" Yellow | 4704781260 ..12" Tan |
| 4704780960 ..9-1/2" Tan | 4704781220 ..12" Black |

HEAVY DUTY UTILITY TONGS

Heavy gauge stainless steel is stronger and more rigid for heavy use.

- 530103977.5" - Light Weight
- 55544099.5"
- 5559051212"
- 555441616"



KOOL TOUCH SCISSOR TONG

Chrome plated heavy duty wire with handle that stays cool up to 180°F.

4704732516"



POM TONGS

Stainless steel.

- 530103206"
- 530103219"
- 5301032212"



HEAVY DUTY LOCKING SCALLOP TONGS

With Edlund's patented locking mechanism and heavy duty replaceable S/S springs.

- 555905179" HD Scallop Tongs
- 5559051812" HD Scallop Tongs
- 5559051616" HD Scallop Tongs
- 55590513Spring Only



EDLUND LOCKING GRIPPER TONGS

These heavy-duty stainless steel grippers with unique flat paddle are ideal for separating frozen burger patties.

- 555641010" Gripper Tongs
- 555641212" Gripper Tongs
- 555641616" Gripper Tongs



**HIGH HEAT
SCRAPERS**

All purpose scrapers resist melting & scratching pans. Resist heat up to 500°F. NSF listed.
 58019629.5"
 580196313.5"
 580196416.5"

SCRAPERS/SPOON-SHAPED SPATULAS

Flat blades for scraping, spoon-shaped blades for scooping & spreading. Seamless construction to resist dirt and bacteria buildup.
 58019019.5" Scraper
 580190513" Scraper
 580190617" Scraper
 58019319.5" Spatula
 580193513.5" Spatula
 580193616.5" Spatula



FLEXIBLE SCRAPERS

Flexible blade, wood handle
 54012659.5", medium blade
 540126612", large blade



MATFER EXOGLASS SPATULAS

Heat resistant to 430°F, dishwasher safe.
 555112420 ...Wide Spatula, 12"
 555654329.875" Spatula
 5556543313.75" Spatula
 5556543417.75" Spatula

555112420



SPARTA® PADDLE SCRAPERS

Nylon blades for temperatures up to 300°F, and stainless steel of nylon handles. Perfect for mixing and stirring.
 80847540" Nylon Handle w/Blade
 80848548" S/S Handle w/Blade
 8084851 Nylon Blade Repl. 4.5 x 7"



WOOD

STIRRING PADDLES

Smoothly sanded hardwood.
 530532424"
 530533030"
 530533636"
 530534242"
 530534848"



**LONG STAINLESS
STEEL PADDLES**

Seamless stainless steel w/tubular handle, blade is 4-3/4 x 9-3/4".
 55504848"
 5550043636"





JACCARD MEAT TENDERIZERS

No chemicals - a healthy way to enjoy meat. Triple-action meat tenderizer with rows of stainless steel saber blades. reduce cooking time, save flavor, less shrinkage.

55537500Mini - 1 row/16 blades

55537502Super - 3 rows/48 blades



HAMBURGER PATTY MOLD

Chrome plated, form identical patties time after time.

450404-3/4" dia.



MEAT TENDERIZER Mallet

Hardwood handle and cast aluminum head, one face is coarse cut, the other fine cut.

450432 x 4-1/4" head, 11-1/4" long

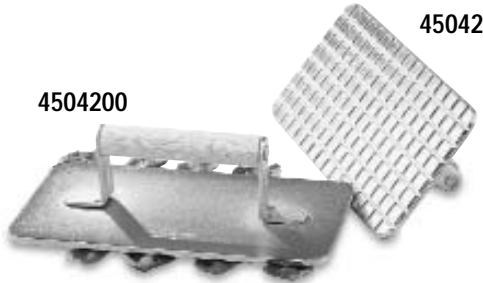

4504200

45042

STEAK WEIGHTS

Steak weights speed cooking on grills and keep bacon from curling. 9 x 4-1/2"

45042Chrome Plated Steel

4504200Cast Aluminum



WOOD POTATO MASHERS

Nickel plated heavy duty steel wire, with long, hardwood handles to reach into deep pots..

555171818" long, Round

555172525" long, Round



BEST HEAVY DUTY MASHER

Stainless steel one piece masher permanently welded to heavy gauge 1" dia. S/S handle.

5551158225" HD



BEST BEAN MASHER

S/S head firmly attached in chrome plated handle, and sealed in epoxy.

5551158125"

PRONTO BEAN MASHERS

Nickel and chrome-plated construction for durability and strength, black textured plastisol-coated handles for a better grip.

555115786" Square, 24-5/8" long

555115794.5" Round, 19-3/4" long

555115806" Round, 24-5/8" long



55511580



55511579

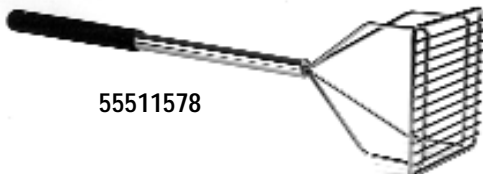

55511578



PRONTO PRODUCTS



TACO BASKET
Designed to fry 6" to 8" tortillas into a crisp, flat shape.
555115681-6 per load
555115721-8 per load



TOSTADA BASKET
Designed to fry 6" corn tortillas into a flat, crisp shape. 1 - 18 per load
55511569



TACO SHELL BASKET
Designed to fry 4 each 7" to 9" tortillas into taco molds.
55511573



TACO SALAD BOWL
Designed to fry 8" to 16" tortillas into unique shapes for taco salads.
55511574

TACO SALAD BOWL
Designed to fry 8 to 16" tortillas into bowl-like shapes for taco salads.
55511575



BAGGING SCOOPS
Controls portions, eliminating over-bagging and broken fries. Balanced to permit natural bag filling. Available in right-hand, left-hand, or dual handle models.
59001012Left hand
59001013Right hand

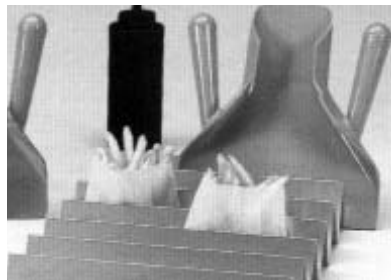

DUAL HANDLE PLASTIC SCOOP
One-piece molded unit eliminates food traps, unlike more expensive metal fry baggers
59001015

FRY BAG RACK
Made of high-impact ABS plastic, holds 24 fry bags.
152-15



KETCHUP COLLECTOR
Holds six ketchup bottles or two #10 cans. Allows complete draining and filling
59001019



CARTRIDGE SAUCE DISPENSERS
Portion control for tartar sauce, guacamole and other sauces
590010011 oz
590010041/2 oz
59013610Piston only
59013622Spout Cap only
5901363Retainer only
5901367Diffuser only

MEAT CHOPPER
Bench-mounted meat chopper makes ground beef and other meats. Furnished with a 3/16" plate, many more available.
53010000Chopper
53010020Chopping Knives
53010022Stomper
530100251/8" Chopper Plate
530100273/8" Chopper Plate
530100283/16" Chopper Plate
530100291/4" Chopper Plate



DICE WITCH
Dices onions and other firm vegetables with one stroke. Fast and easy to use, provides 3/8" square.
59001020Dice Witch
59001021Blade Set

PRINCE CASTLE

Kitchen Supplies



REDCO® LETTUCE KING IV

Fast & reliable, it delivers the speed, consistency and performance you need at a fraction of the cost of an electric powered machine.

5554400.....1" cut



MANDOLINE

The ultimate vegetable slicer, made of 18/10 stainless steel. Comes with combinations of 30/20/10 plus waffle and carver. Easy to clean. 4 1/2" w. x 14 1/4" l

55500183Mandoline
w/Guard Cutter/Shredder



VOLLRATH POTATO CUTTER

Clean, durable S/S "V" trough for smooth operation. Sure-grip handle, mounts to table or wall

45029Potato Cutter Complete
450292613/8" Cutting Die
450296013/8" Push Block

ALEGACY FRENCH FRY CUTTER

Heavy duty cast body, cast iron handle and a stainless trough for reliable, long-lasting service. The frame, pusher block and cutting frame are rust proof. Capacity of 6" long potatoes, and will process up to 50 lb. of potatoes per hour. can be wall or table mounted.

555040001/4" Potato Cutter
555040023/8" Potato Cutter
555040041/4" H-15C Cutting Head
555040053/8" H-15 Cutting Head
555040061/4" H-16P Pusher Head
555040073/8" H-16 Push Block

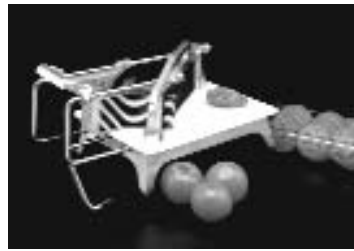
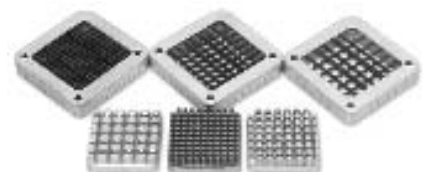

REDCO® TOMATO PRO

Prepare perfect tomato slices fast. Ideal also for strawberries or mushrooms in high volumes. Holds firm on countertop while operating. NSF listed.

55506433/16" Tomato Pro
55506441/4" Tomato Pro
555653.....3/16" Repl. Blades
555654.....1/4" Repl. Blades

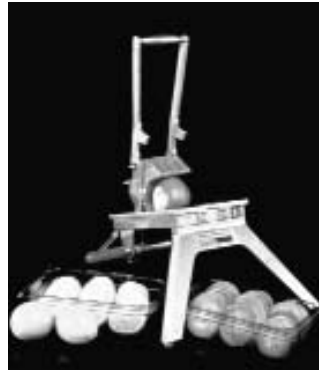

REDCO® ONION KING

Greater yield & portion control are achieved with exact slice thickness. Also great for potatoes for Cottage Fries, Squash, or other firm vegetables.

555500.....3/16" Onion King
555501.....1/4" Redco Onion King
5555001.....509 Repl. Blade Set 3/16"
5555511501 repl. Blade Set 1/4"



REDCO® WEDGEMASTER

For superior portion control of lemons, limes, pickles, tomatoes and potatoes, and yields a great looking product.

555808.....8 Section
5551212.....12 Section



KEEN KUTTER SHAVER

Cut fresh vegetables as you need them. Slice, dice, shred - potatoes, onions, carrots, green peppers, lettuce and other fresh vegetables. Save the cost of buying less-flavorful pre-cut or frozen vegetables. Save storage space.

55530038Keen Cutter Complete - 3/8" head
55530014Keen Cutter Complete - 1/4" head
55520021/4" Pusher Block
55520033/16" Pusher Block
55520043/8" Pusher Block
55522011/2" Cutting Head
55522021/4" Cutting Head
55522033/16" Cutting Head
55522043/8" Cutting Head
555222Small Blades 12/pk
5552243/16" Spacer Blade
5552251/4" Spacer Blade
5552263/8" Spacer Blade
5552271/2" Spacer Blade



**HEAVY DUTY
MANUAL JUICERS**

Dependable design exerts 2000 pounds of extraction pressure for juicing lemons, limes, oranges and grapefruits, with swing-out juice collector cup.

A 606932.....Hamilton Beach 932

B 44023JE-23

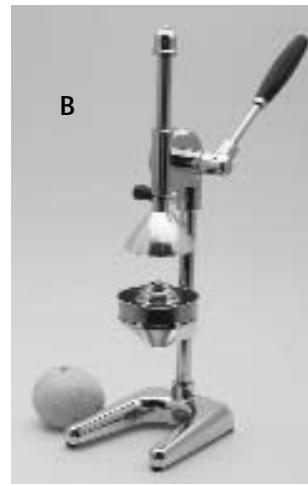

FIRM GRIP CAN OPENER

Ergonomic soft-grip handles provide non-slip grip for comfort and security.
55500603



HAND CAN OPENER

Chrome plated rotary knife type, gear operated, with a cap remover.
540407



NEW G SERIES CAN OPENER

Can opener with standard length bar, stainless steel shaft, and plated base. Features take-apart design. NSF listed.
55590529



EDLUND MANUAL CAN OPENERS

The standard of the industry since Edlund invented them over 75 years ago. With rust-resistant arbor, new base with plastic insert and Delrin plastic bushing to reduce friction and improve handle wear.

- 55590500#1 Can Opener w/ Base
- 55590502#1 Can Opener w/o Base
- 55590506#2 Can Opener w/ Base
- 55590507#2 Can Opener w/o Base
- 55590504S-11 Can Opener w/ Base
- 91324000#1 Can Opener Knife
- 91324001#1 Can Opener Gear
- 91324006S-11 Can Opener Knife
- 91324007S-11 Can Opener Gear
- 91324010#2 Can Opener Knife
- 91324011#2 Can Opener Gear
- 91324015Electric Can Opener Knife
- 91324016Electric Can Opener Gear

Kitchen Supplies



S/S ZESTER

Great for zesting lemons, oranges or grapefruits. Plastic comfort grip. 50003705



CHEESE CUTTER

Chrome plated with adjustable rust-proof wire allows you to cut block cheese to any thickness. 45020



FRANMARA CHEESE PLANE

Smooth beechwood handle with 18-10 stainless blade. 555010756-3/4"



COFFEE SCOOP

Great for scooping ground coffee, cocoa or tea from bag. Stainless steel. 500000511/2 oz., 1 Tbsp



NON-STICK GARLIC PRESS

Aluminum with w/non-stick coating. 50000093



STAINLESS SCOOPER/CHOPPER

Slice, chop, scrape, mince and scoop with one handy tool. S/S with etched 6" ruler. LGK-3620Special Order



PEELER

Fruit & vegetable peeler with double edge floating blade. 555000452-1/2" blade



GARLIC PRESS

Die cast aluminum, 6" long 530330



A



C



B



D

TOOLS WITH A SOFT TOUCH

AMCO kitchen tools have contoured handles of non-slip Santoprene® thermal plastic for better handling ease. All metal parts are dishwasher safe stainless steel.

- A. 55500600Swivel Peeler
- B. 55500601Black Lemon Zester
- C. 55500607“Y” Black Peeler
- D. 55500608Black Cheese Grater

AMCO
• 1947 • 1968 • 1998 •



CYLINDER CHEESE GRATER

Most widely used in restaurants, for fast, easy grating of cheese, chocolates, even nuts. Great for table use.
55584000White, Right-Hand use



FOUR-SIDED GRATER

Quality stainless steel for grating and slicing of cheese, potatoes and meats.
555533009-1/2" high



SKEWERS

Stainless steel oval wire skewers with tempered blades and loop ends.
540600238"
5406002510"
5406002712"



GARNISH/SERRATOR

Stainless steel corrugated blade and hardwood handle.
540600597 x 2"



KITCHEN SHEARS

Stainless blades with bone shear.
530300.....3-1/2" Blade



APPLE DIVIDER

Die-cast metal with rust-proof knives. Cuts 14 equal slices.
540600544-3/4" dia.



SCRAP BLOCK

Fits standard 5-3/4" opening in dish table. Heavy plastic.
540600554"H x 6-3/4" dia.



BASTING COVER

Aluminum with bakelite knob, 2" clearance, 10" diameter.
55500426

Kitchen Supplies

NYLON HI-HEAT TOOLS

These essential tools are safe to use with non-stick cookware coatings, and are heat-resistant up to 400°F.

- A. 500001009.5" Scraper
- B. 5000020012.5" Spatula
- C. 5000030011.25" Wide Turner
- D. 5000040012" Ladle
- E. 5000060012" Slotted Spoon
- F. 5000070012.5" Horizontal Turner
- G. 5000050012.5" Spoon

PROGRESSIVE
INTERNATIONAL CORP.

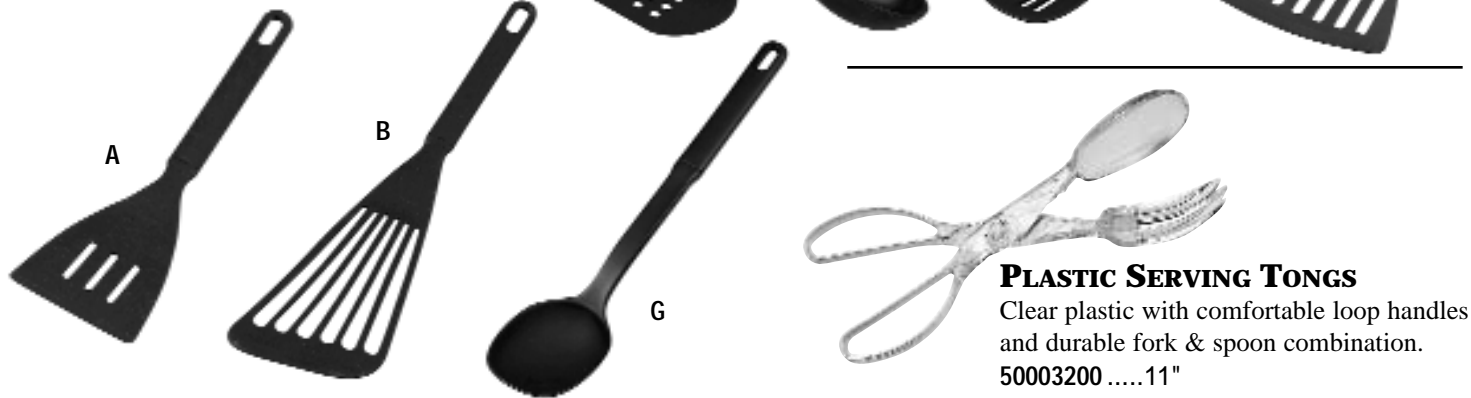

PLASTIC SERVING TONGS

Clear plastic with comfortable loop handles and durable fork & spoon combination.
5000320011"

PROGRESSIVE
INTERNATIONAL CORP.



Lincoln WFAE-EVER

NON-STICK EGG POACHER

Dent-resistant aluminum alloy.
43038144Poacher
43038644Rep'l. Cup



CALL BELL

Durable nickel-plated bell with plastic base. loud ring.
5407153" dia.



SHRIMP DEVEINER

Peels and deveins shrimp in one easy motion.
50003147



PROGRESSIVE
INTERNATIONAL CORP.

DELUXE EGG BEATER

Sure-grip handles, S/S blades and heavy duty gears.
5406005612"

ELECTRIC HAND MIXER

5-speed Classic Plus hand mixer from Kitchen Aid.
606-41096



EGG SLICER

Polished die-cast aluminum. Quickly cuts egg slices for salads and garnishes.
450214-1/4"



LEVER EGG SLICER

Cast aluminum base with 7 S/S wires
45022



LUX TIMER

Times in minutes up to one hour and has insistent ring up to 18 seconds.
555192901.....2-3/4" dia.



QUARTZ DIGITAL TIMER

Compact, accurate, durable. Times up to 19 hours and 59 minutes. magnetic back, battery included.
50030000



SIXTY-MINUTE TIMER

Mechanical bell timer. Loud ring
55500168

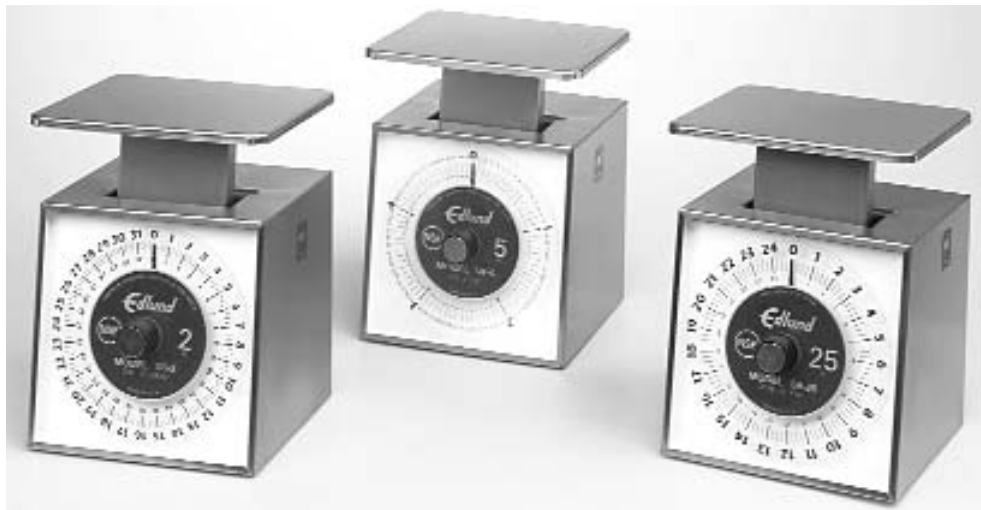

**EDLUND
STAINLESS STEEL
PLATFORM SCALES**

These popular portion scales are NSF listed. Stainless springs, mechanisms and housing.
6-3/8L x 6-1/2W x 9"H
5559052032 oz x 1/4 oz
555905215 lb x 1 oz
5559052225 lb x 4 oz



DIGITAL PORTION/RECEIVING SCALE

Low profile, high performance portion scale features compete portability with built-in rechargeable battery. With built-in foot/tare switch.
LP-10H.....12-1/2 lb x .1 oz.



EDLUND PORTION SCALE

Electric stainless steel portion scale is NSF listed. Automatic pushbutton tare. Also operates with 9V battery (not included). 6 x 6-3/4" S/S platform.
5559051548 oz x .1 oz/2 gm.



ONE POUND PORTION SCALE
 Small, compact portion control scale with stainless steel platform. Durable ABS plastic housing with nickel plated bezel. 1 lb X .25 oz
 55500160



FRENCH FRY PORTION SCALE
 Assure extra profit from careful portion control. Special platform keeps tacos and fries bags upright. Stainless steel platform. Durable ABS plastic housing with nickel plated bezel. 1 lb X .25 oz
 55500162



ICE CREAM PORTION SCALE
 Helps eliminate over runs. Stainless steel platform. Durable ABS plastic housing with nickel plated bezel. 2 lb X .25 oz
 55500164



ELECTRONIC PORTION SCALE
 50 hr. rechargeable battery included, Auto off, Tare feature, Removable stainless steel platform; ABS chassis; LCD display; Sealed electronic components; Dual load cell protection up to 250 lbs; AC adapter included; 9V battery adaptable; NSF certified; 6 lb x 0.1 oz
 55500165



20 LB DIAL SCALE
 Scales feature temperature compensated mechanism, standard baked enamel finish and stainless steel platform. Color coded lens by capacity (Blue). Large numerals; Zero knob tare feature; Shatterproof lens; 20 lb x 1 oz.
 55500820



60 LB DIAL UTILITY SCALE
 Twin spring weighing mechanism; Angled dial; Angled dial; Shatterproof lens; Fixed dial; Baked enamel finish; Chrome plated steel platform; Platform: 13" x 13"; 60 lb x 4 oz
 55501060



25 LB DIAL SCALE
 Fast check weighing of incoming food, Rustproof Anodized Aluminum Chassis with Stainless Steel Platform & Bezel. Large numerals; Shatterproof lens; Zero knob tare feature; 25 lb x 2 oz
 55500154



TAYLOR THERMOCOUPLE THERMOMETER
 Compact size, built-in sharp-tip probe, slips inside meter for handy storage. 9V battery, probe & belt-loop case included.
 55509800 . . -40/500°F



ACCUTUFF THERMOCOUPLE THERMOMETER
 With Duraneedle insertion/immersion technology. When accuracy is your top priority, this instrument is for you.
 40/500°F; -40/260°C
 55533032





TAYLOR



POCKET DIGITAL THERMOMETER

Heavy duty stainless steel stem with on/off button. Fast update button. Instant read digital display. Dual read °F/°C switchable modes. Recalibratable.
5559865..... -60/300°F.



POCKET DIAL BI-THERM®

1" dial with 5" slim stem and a plastic pocket case. Shock proof protection. Stainless steel parts. Unbreakable polycarbonate crystal.
5556092 . . .0/220°F
5556093 . . .5/550°F



DIGITAL POCKET THERMOMETER

Professional Series digital pocket thermometer large, easy to read display & On/Off switch to extend battery life. One second update Durable, stainless steel stem. Includes protective case and battery
5559840.....-58/302°F, 1" dia.



FREEZE GUIDE THERMOMETER

Perfect for refrigerators and freezers, it is rust proof. It hangs or stands and is permacolor filled.
5555925.....-40/80°F



DIAL MEAT THERMOMETER

Clear unbreakable 2-3/4" dial, 5-1/2" stem. NSF listed
5555939.....120/200°F



STICK-ON MAXI DIAL

Plastic case for many uses, double face adhesive tape provides for easy placement in freezers & room locations.
5555380.....40/120°F



DIAL OVEN THERMOMETER

Stainless steel case, stands or hangs, 2-1/2" high.
5555931.....200/500°F



DIAL REFRIGERATOR FREEZER THERMOMETER

Stainless steel case, it hangs or stands. Cold zones are color coded.
5555923.....-35/70°F

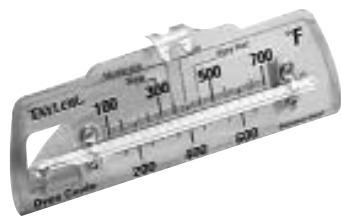

OVEN THERMOMETER

Non-toxic permanent color thermometer. Hangs from oven rack.
5555921.....100/700°F



CONFECTIONERS' THERMOMETER

Non-toxic permanent color thermometer. Durable, with metal guard and plastic hanger top.
5555983.....90/400°F; 12"



CANDY DEEP FRY THERMOMETER

Adjustable pan clip. 2-1/2" dial, 5-1/2" probe. NSF list, Dishwasher safe.
5555972.....100/400°F

Food Containers

CAMSQUARE CLEAR CONTAINERS

CamSquare® containers take up 33% less space than round containers! And, they are made from Camwear polycarbonate so they will actually bounce off a tile kitchen floor and not break! Printed graduations on the outside show you how much is inside. Color coded snap-tight covers feature tabs so they can be easily removed.

- 505021602 Qt Clear Square Container
- 505021624 Qt Clear Square Container
- 50502163Lid for 2, 4 Qt Container
- 50502164 6 Qt Clear Square Container
- 50502165Lid for 6 and 8 Qt Container
- 505021668 Qt Container
- 5050216812 Qt Container
- 5050217318 Qt Clear Square Container
- 5050217422 Qt Clear Square Container
- 50502169Lid for 12, 18, 22 Qt Container



CAMBRO PAIL

Cambro's multipurpose polyethylene Pail is a real workhorse. Great for mixing, storing or transporting. Durable, stain resistant and dishwasher safe. The tab-off cover (optional) produces a great transporter. 5050232222 Qt Pail

CAMBRO

CAMBRO CLEAR ROUND CONTAINERS

The round shape promotes proper air circulation. The durable polycarbonate construction is virtually unbreakable. Plus, it withstands temperatures of -40°F to +210°F, so you can use them in just about any condition. Food acids, oils and alcohol won't stain or harm them. The molded-in handles offer convenience in lifting.



- | | |
|-------------------------------------|--|
| 505023101 Qt Container | 50502317Cover Fits 6 and 8 Qt |
| 50502311Cover Fits 1 Qt | 5050231812 Qt Container |
| 505023122 Qt Round Container | 50502321Cover Fits 12, 18, 22 Qt |
| 505023134 Qt Round Container | 5050231918 Qt Container |
| 50502314Cover Fits 2 and 4 Qt | 5050232022 Qt Round Container |
| 505023156 Qt Round Container | 50502323Cover for 22 Qt |
| 505023168 Qt Round Container | |

ECONOMICAL SQUARE SPACE SAVERS

CARLISLE
FoodService Products

Translucent polypropylene containers offer "contact clarity" for easy identification of products; withstand temperatures from 32° to 170°F. White polyethylene containers will withstand temperatures from -40° to 180° F. NSF listed; dishwasher safe

- | | |
|-------------------------------------|--|
| 570308002 Qt White Container | 570308038 Qt White Container |
| 570308014 Qt White Container | 57030806Lid for 6 and 8 Qt Cont. |
| 57030805Lid for 2, 4 Qt Cont. | 5703080418 Qt White Container |
| 57030802 6 Qt White Container | 57030807Lid for 18 Qt Cont. |



CARLISLE BAINS MARIE

The original round food storage containers. Seamless, translucent polypropylene containers are NSF listed and dishwasher safe. Will withstand temperatures from -40° to 180° F.

- 58026022 Qt White Bain Marie
- 58026043.5 Qt White Bain Marie
- 58026672 & 3.5 Qt Lid
- 58026066 Qt White Bain Marie
- 58026088 Qt White Bain Marie
- 58026686 & 8 Qt Lid
- 580261212 Qt White Bain Marie
- 580261818 Qt White Bain Marie
- 580622222 Qt White Bain Marie
- 580266912, 18, 22 Qt Lid

CARLISLE
FoodService Products



800-877-0087

141



CAMBRO
AN AMERICA'S FOOD SERVICE SUPPLY COMPANY

CAMWEAR FOOD STORAGE BOXES

Camwear Food Storage Boxes' clear finish assure instant food identification and inventory-at-a-glance for premium organization and time savings. Tough Camwear polycarbonate stands up to tough treatment, withstanding temperature extremes from -40°F to +210°F. Camwear Boxes stack securely (loaded or unloaded), fit standard carts and racks and are dishwasher safe. Their smooth surfaces are easy-to-clean and their snap-tight covers are available hinged or new SlidingLid™ for easy access.

- 5803300.....18 x 26 x 9" Food Box
- 5803301.....18 x 26 x 15 Food Box
- 5803302.....18 x 26" Food Box Lid
- 5803304.....18 x 12 x 9" Food Box
- 5803305.....Slide Lid 18 x 26"
- 5803306.....18 x 26 x 3.5" Food Box
- 5803307.....18 x 12 x 3.5" Food Box
- 5803308.....18 x 26 x 6" Food Box
- 5803309.....12 x 18 x 6" Food Box
- 5803310.....12 x 18" Food Box Lid
- 5803311.....Slide Lid 12 x 18"

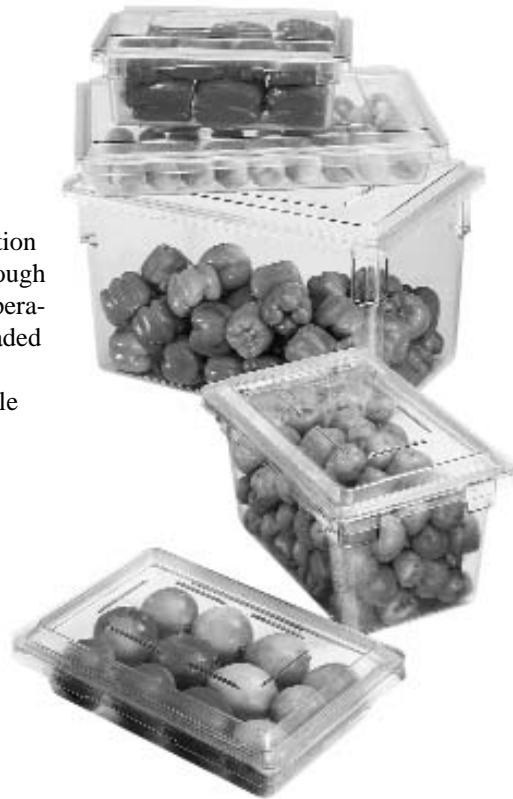

WHITE POLY FOOD BOXES

Cambro's Poly Food Storage Boxes are a great value in impact and scuff resistant protection for wet or dry storage. They maximize available shelf space, stack and nest easily, resist stains, acids and odors and are dishwasher safe. Snap-tight covers are available for all seven sizes.

- 5803690.....12 x 14 x 5" Food Box
- 5803507.....12 x 18 x 3.5" Food Box
- 5803509.....12 x 18 x 6" Food Box
- 5803504.....12 x 18 x 9" Food Box
- 5803510.....12 x 18" Food Box Lid
- 5803506.....18 x 26"3.5" Food Pan
- 5803508.....18 x 26 x 6" Food Box
- 5803500.....18 x 26 x 9" White Food Box
- 5803501.....18 x 26 x 15" Food Box
- 5803502.....18 x 26" Food Box Lid



CAMBRO CLEAR COLANDER

Ideal for draining vegetables, fruits, meats, fish and poultry to protect freshness. Made of Camwear polycarbonate, these Colanders are durable, easy-to-clean and dishwasher safe.

- 5803303.....18 x 26"

INGREDIENT BIN

Mobile bin with sliding hinged lid, lightweight, made of FDA compliant materials with rounded corners & smooth walls. 3" casters fixed front, swivel rear.

- 5803600.....White, clear lid





CHEF COATS & APRONS

RESCO carries the best selection of Chef Coats & Pants and Aprons. We stock many colors and patterns, and we can get many more on special order.

Chef Coats

- 5303451.....Medium Chef Coat with Fish
- 5303452.....Medium Chef Coat with Pepper Trim
- 530345.....White Medium Chef Coat
- 5303451L.....Large Chef Coat with Fish Trim
- 5303451XL...Xlarge Chef Coat with Fish Trim
- 5303452L.....Large Chef Coat with Pepper Trim
- 5303452XL...Xlarge Chef Coat with Pepper Trim
- 530345L.....Large All White Chef Coat
- 530345XL.....Xlarge All White Chef Coat

Aprons

- 55567024.....White Bib Apron 65/35
- 55567025.....White Bib Apron with 2 Reg.
- 5303353.....Royal Blue Bib Apron
- 5303354.....Bright Red Bib Apron
- 5303355.....Burgundy Bib Apron
- 5303356.....Black Bib Apron
- 5303357.....Hunter Green Bib Apron
- 5303432.....Green Apron w/3 pockets
- 5303434.....Red Apron
- 5303436.....Black Apron
- 5551504.....White 4 Way Apron
- 5551505.....White Waist Apron
- 5553421.....Waist Apron with 3 Pockets
- 5553422.....Waist Apron with 3 Pockets
- 5553423.....Waist Apron with 3 Pockets
- 50517000.....Brown Vinyl Bib Apron
- 55589501.....Plastic Bib Apron
- 55567030....."Designer" White Bib Apron (not shown)
- 55567031....."Designer" Colored Bib Apron (not shown)



TOWELS

Quality cotton towels.

- 80811412.....Terry Towels 16"x26"
- 80811413.....Ribbed Bar Towels
- 80811416.....Red Stripe Glass Bar Towels



CHEFS' HAT

- 555131.....8-7/8"



POT HOLDERS & HOT PADS

- 5553500215" Puppet Oven Mitt Nomex
- 5553500715" Puppet Oven Mitt Kevlar
- 5553500818" Puppet Oven Mitt Kevlar
- 5553501915" Puppet Oven Mitt
- 5553502015" Regular Oven Mitt Cotton/Poly
- 5550011317" Terry Oven Mitt
- 5550011515" Silicone Oven Mitt
- 5550011717" Silicone Oven Mitt
- 5550011912" Pyrotex Oven Mitt
- 5550012117" Pyrotex Oven Mitt
- 55500123Silicone Pot Holder
- 55535016Baker's Hot Pad Nomex
- 555001258" Terry Pot Holder
- 80830318.5" Terry Pot Holder
- 55500127Pan Grabber



CUT RESISTANT GLOVES

Stainless steel threads are woven into glove fibers for superior resistance for all who work with sharp knives, slicers, etc. Help prevent painful and costly lacerations.

- 55503201Small
- 55503200Medium
- 55503202Large
- 55503204XLarge



NITRILE GLOVES

Sol-Vex gloves are made of a high-performance nitrile compound which provides an outstanding strength and chemical resistance. When exposed to solvents, as well as caustics and animal fats, Sol-Vex gloves are a superior choice over rubber or neoprene. They won't swell, weaken, or degrade, and they offer better protection against snags, punctures, abrasions, and cuts. And, as added benefits, Sol-Vex gloves do not promote contact dermatitis, and their component materials comply with FDA regulations for food contact. 19" long

- 80817300Size 9 Nitrile
- 80817301Size 10 Nitrile



NEOPRENE COATED GLOVES

Neoprene gloves offer broad-spectrum protection, with excellent resistance to a wide range of chemicals, including oils, acids, caustics, and solvents. The gloves are case hardened to increase chemical and abrasion resistance over ordinary neoprene gloves. 12" long.

- 80818036Large
- 80818037Size 9

RUBBER GLOVES

Made of natural rubber, 16" long.

- 80818034Medium
- 80818035Large



Cutting Boards



MAPLE CUTTING BOARDS

The finest kiln-dried hardwood cutting boards. Both sides are finished, making these boards reversible.

- 555212.....10 x 16 x 1"
- 555214.....15 x 20 x 1-1/4"



MAPLE CUTTING BOARDS

The finest kiln-dried hardwood cutting boards. Both sides are finished, making these boards reversible.

- 5550004218 x 24 x 1-1/2"



BREAD BOARD W/KNIFE

Hardwood cutting board holds 12" bread knife.

- 53010512

KOLOR-CUT™ CUTTING BOARD SYSTEM

Reduce cross contamination by using color-coded cutting boards. Will not dull knives but has added toughness against grooving and scarring. Heat resistant to 185°F, cold resistant from -40°F. Non-porous, non-absorbent. NSF listed.

- 5551172712 x 18 x 1/2" White
- 5050500015 x 20 x 1/2" Kolor-Cut Combo Set
- 5551172215 x 20 x 1/2" White
- 5050500115 x 20 x 1/2" Red
- 5050500215 x 20 x 1/2" Yellow
- 5050500315 x 20 x 1/2" Green
- 5050501018 x 24 x 1/2" Color-Cut Combo Set
- 5551172818 x 24 x 1/2" White
- 5050501118 x 24 x 1/2" Red
- 5050501218 x 24 x 1/2" Yellow
- 5050501318 x 24 x 1/2" Green
- 50505015S/S Cutting Board Stand



BOARD MATE®

Stops sliding and eliminates unsanitary wet-towel method of stabilizing boards. Non-absorbent, dishwasher safe and NSF listed.

- 5050131813 x 18 "



WHITE POLY CUTTING BOARDS

A quality, durable easy-to-clean cutting surface at an attractive price. Will not chip, crack, peel or warp; non-porous, non-absorbent, and stain resistant. Lightweight and long lasting, will not dull knives. 1/2" thick.

- 5551190012 x 18"
- 5551172712 x 18"
- 5551172215 x 20"
- 5551190215 x 20"
- 5551190418 x 24"
- 5551172818 x 24"



3 WAY KNIFE SHARPENER
55507080Dexter

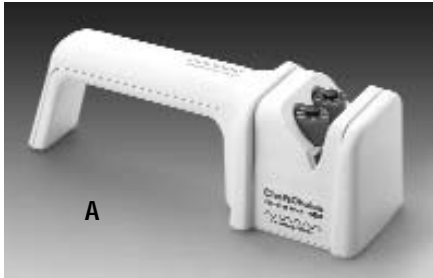

A

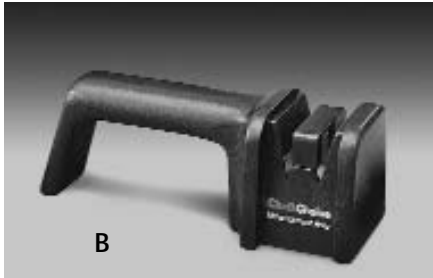

B

**DIAMOND HONE™
MANUAL SHARPENERS**

Revolutionary system for serrated or "never-needs-sharpening" blades, and 2-stage sharpener for straight edge blades.

- A. 5550430for serrated & "never-needs-sharpening" blades
- B. 5550450for straight edge blades

ChefsChoice



COMMERCIAL DIAMOND HONE® KNIFE SHARPENER

This 2 stage commercial electric knife sharpener uses 100% diamond abrasives in stage 1 and ultra-fine honing disks in stage 2 to sharpen all kitchen knives (including serrated, file and butcher) to hair-splitting sharpness in seconds. The alternative to outside knife sharpening services, it will never detemper the knife blade and features a powerful motor, precision angle guides and a sturdy compact design.
5552000.....Chef's Choice 2000



NORTON CRYSTALON BENCH STONES
5406003711.5 x 2.5 x 1" Combo Bench Stone w/ Box
spec. order ...11.5 x 2.5 x 1" Bench Stone only

NORTON INDIA BENCH STONE
54060042IB8 8 x 2 x 1" Bench Stone



NORTON MULTI OILSTONE SHARPENER
Complete sharpening system for all commercial kitchen cutlery. 3 stones mounted in a steel frame, inside a reservoir type base.
54060039Medium Crystalon 11.5 x 2.5 x 1"
54060040Coarse Crystalon 11.5 x 2.5 x 1"
54060041Fine/Med/Coarse Kit w/oil & reservoir
54060035XB2 Sharpening Oil (quart)
540600433-in-1 Sharpener Kit w/6 x 2 x .5" stones
spec. order ...Fine India 11.5 x 2.5 x 1"

EDLUND STAINLESS STEEL KNIFE RACK

Long skirt to protect blades.
12 x 12 x 2-1/2"
55590511



MAGNETIC KNIFE HOLDER

Get quick access to your most important kitchen tools. Attractive wall-mounted holder for cutlery, whips, and metal utensils.

5551670012" KM-12WG
5551670218" KM-18WG
5551670424" KM-24WG



SANTUFF® RUBBER CUTTING BOARDS

Self-healing surface stands up to abuse and wear in commercial kitchen and will last longer than any board on the market. Knives stay sharper longer with specially formulated, non-absorbent, non-porous rubber material, will not retain bacteria. NSF certified and USDA accepted.

5551172012 x 18 x 1/2" thick
5551172315 x 20 x 1/2" thick
5551172618 x 24 x 3/4" thick



COLOR CODED PARING KNIVES

Guard against cross contamination with these color-coded Sani-Safe® cutlery line. Quality, stain-free, high-carbon steel with the ultimate edges, hand ground and honed. High impact "Grip-Tex" handles of polypropylene textured and formed for slip-resistant grip, safety, and tough use. An impervious seal of blade and handle provides the utmost sanitary bonding and prevents the blade from pulling out.. Handles will withstand high and low temperatures. Easily cleaned. Same weight and balance as wood-handled knives.

555153743-1/4" Blade Green
555153753-1/4" Blade Red
555153763-1/4" Blade Yellow
15303C3-1/4" Blade Blue
15303T3-1/4" Blade Tan
555153633-1/4" Blade White



GERMAN STEEL CONNOISSEUR CUTLERY

The finest professional cutlery for hotels, restaurants, and institutions. Designed and produced with traditional Dexter/Russell® experience and craftsmanship.

- Stain-free, high-carbon steel blades, with edges stone-ground by hand & honed to ultimate sharpness.
- Formed, sanitary handles of laminated rosewood are impervious to stain, hot water, and food acids.
- Secured with large brass compression rivets.

5550121213F-6 Flexible Boning Knife
5551201245-10 10" Cooks Knife
5551202245-12 12" Cooks Knife
5551207248-10 10" Cooks Knife
5551302240D-10 10" Roast Slicer
5551303240D-12 12" Roast Slicer
5551304240D-14 14" Roast Slicer
55507042C-12 12" Chefs Steel
5551501225-3 3" Paring Knife



SANI-SAFE® CUTLERY

Widest line of sanitary, NSF-Certified, professional cutlery in the world.

- Quality, stain-free, high-carbon steel with the ultimate edges, hand ground and honed.
- High impact "Grip-Tex" handles of polypropylene textured and formed for slip-resistant grip, safety, and tough use.
- An impervious seal of blade and handle provides the utmost sanitary bonding and prevents the blade from pulling out.
- Handles will withstand high and low temperatures.
- Easily cleaned.
- Same weight and balance as wood-handled knives.



- 55500136SG136 6" Wide Stiff Boning
- 55510493S134 3" Oyster Knife
- 55509223S118-14DH 14" Cheese Knife
- 55513403S140N-10SC 10" Slicer
- 55513603S163-5SC 5" Offset Utility
- 55524422S163-7SC-PCP 7" Offset Sandwich
- 55524423SG163-9SC 9" Offset Sandwich
- 55515363S104 Paring Knife
- 55515373S104SC Scalloped Paring Knife
- 55524323SG107 3.25" Clip Point Paring
- 55524333SG104 3.25" Cooks Style Paring
- 55516193S171 2.5" Turner Spatula
- 55516363S286-8 8"x3" Turner
- 55516433S285-3 4"x3" Hamburger Turner
- 55516483S174 4.5"x2.25" Pie Knife
- 55516503S176 6"x5" Pizza Server
- 55512453S145-10SC 10" Cooks Knife
- 55517433S284-6-1/2 6.5" Frosting
- 55524073SG132-10 10" Cimenter Steak
- 55524153SG145-8 8" Cooks Knife
- 55524163SG145-10 10" Cooks Knife
- 55524213SG156SC 6" Scalloped Utility
- 55524253SG158SC 8" Scalloped Utility
- 55524263SG142-9SC 9" Scalloped Utility
- 55524273SG140-12GE 12" Granton Edge
- 55524403SG173SC 3.5" Scalloped
- 55524023SG136N 6" Narrow Boning
- 55527393S173 3.5" Sandwich Spreader
- 55527613S284-8PCP 8" Bakers Spatula
- 55517303S196 6"x3" Dough Cutter

RUSSELL IMPORTED - PLASTIC HANDLE

Designed for those who must have an imported professional line at a lower price point, this is the best value in imported cutlery. NSF Certified. Blades are 400 series stain-free, high-carbon steel and are hollow ground for easy edge maintenance and rapid resharpening. Servers, turners, and scrapers of stainless steel are ground with precision for the right flexibility and stiffness. Handles are of high impact polypropylene and slip-resistant. Easily cleaned.



- 55531617P94821 6" Stiff Narrow Boner
- 55531640P94850 4" Griddle Scraper
- 55531641P94851 4"x2.5" Pancake
- 55531642P94852 4.5"x2.25" Pie Knife
- 55531643P94853 5" Pie Knife
- 55531646P94856 8"x3" Cake Turner
- 55531647P94857 8"x3" Perf Turner
- 55531644P94854 4"x3" Hamburger Turner
- 55531645P94855 6"x3" Hamburger Turner
- 55531648P94858 5"x4" Hamburger Turner
- 55531603P94803 8" Scalloped
- 55531604P94804 10" Scalloped Slicer
- 55531606P94807 8" Offset Sandwich
- 55531611P94843 3.125" Tapered Paring
- 55531612P94846 3.125" Tapered Paring
- 55540525P40525DP 3.25" Paring Knife
- 55531366P40003 2.75" Paring Knife
- 55531600P94801 8" Cooks Knife
- 55531601P94802 10" Cooks Knife

DEXTER RUSSELL CUTLERY

- The choice of professionals for both quality and selection
- With proper blade length shape, flexibility, balance, handle design.
- Edges are hand-ground and honed to ultimate sharpness.
- Blades are available in either specially processed high-carbon or stain-free, high-carbon steel.
- Formed or traditional-shaped wooden handles are tightly secured to blade tangs with compression rivets

Cutlery



55508040 . .5198 8" Chinese Chefs Knife
55508020 . .5178 8" w/Hi Carbon Steel Blade



55513520 . .S42G8SC 8" Serr. Utility



55508010 . .5096 Cleaver 6"



55508060 . .5287 7" Cleaver



55513530 . .S42G9SC 9" Utility Slicer



55515120 . .S194-1/4R 3.25" Paring



55513290 . .S2096SC 6" Ser Utility Slicer



55518140 . .S2592SC 3.25" Grapefruit



55501250 . .S13G6R 6" Wide Boning Knife



55509210 . .S18914 14" Cheese Knife



55512100 . .48910 10" Cooks Knife



55512381 . .63689-10 10" Cooks Knife
55512391 . .63689-12 12" Cooks Knife



55514050 . .S2826 22" 1/2 Broiler Fork



55514110 . .28912MF 12" Forged Cooks Fork
55514120 . .28914MF 14" Forged Cooks Fork



55514070 . .S2896 11" Carver Fork



55516100 . .S244 4.5" Pie Knife



55516110 . .S245R 5" Pie Knife



55517040 . .S496 6"x3" Dough Cutter



55517110 . .S2496 6.5" Frost Spatula



55517160 . .S2498 8" Baker's Spatula
55517220 . .S24910 10" Bakers Spatula





55516090 . .S242-1/2 4 x 2" Turner



55516160 . .S8696 6"x3" Turner



55516170 . .S8698 8"x3" Turner



55516201 . .S240 2.5" Mini Turner



55516390 . .S8698SQ 3"x8" Square Turner



55516473 . .172 1/2 4 x 2" Turner



55518120 . .S2493-1/2SC 3.5" Sandwich Spreader



55510161 . .23 2-3/8" Oyster Knife



55516271 . .85849 4"x3" Turner



55550401 . .3F3 3" Flexible Pan Scraper



5551629185869 6"x5" Turner



L8386C 8"x3" Long Handle Turner



55516231 . .2386C-8 8"x3" Cake Turner



BUTCHER & CHEF'S STEELS

- A. 55507141.....1214-10 10" Wood Handle
- A. 55507191.....1214-12 12" Wood Handle
- A. 55507221.....1214-14 14" Wood Handle
- B. 55507201.....1237-12 12" Wood Handle
- B. 55507231.....1237-14 14" Wood Handle
- C. 55507343.....12SXL 12" Plastic Handle
- D. 55508101.....DDS-12 12" Diamond Steel
- E. 55507042.....C-12 12" Wood Handle



SOFGRIP CUTLERY

Ergonomic, comfortable handles with all the great features of SaniSafe Cutlery.
 55524303RH SGL155NSC 5-1/2" Narrow Scalloped



CUTLERY GIFT SETS & CASES

- 55520204RH CC1 7 Piece Cutlery Set w/Nylon Case
- 55520192RH 550 3 Piece Knife CS Only
- 55520202RH 50 7 Piece Knife Case Only

Cutlery

RH FORSCHNER CUTLERY

The preference of professionals since 1855.
Swiss made Victorinox stainless steel blades.
NSF listed.



55536112 . .40084 12" Butcher Steel
55536114 . .40089 14" Butcher Steel



55548010 . .10" Wavy Edge Cook's Knife



55543008 . .40020 8" Cook's Knife
55543010 . .40021 10" Cooks Knife



55549012 . .40240 12" Roast Slicer
55549014 . .40241 14" Roast Slicer



55540310 . .0131 Cimeter 10" Knife
55540312 . .0133 Cimeter 12" Knife



555406061 .40013 6" Boning Knife



55540760 . .40017 6" Boning Knife



55588200 . .3.25" Paring Knife



55588211 . .3.25" Paring Knife Wavy Edge



55518200 . .3.25" Wood Hdl. Paring Knife

BLUE MICROBAN BY RH FORSCHNER

Microban Product Protection is a safe, durable and effective antimicrobial protection built in to help keep them cleaner between washings. It inhibits the growth of bacteria, mold and fungus that cause odor and stains.



55546510 . .Blue Micro. 5" Boning
55546512 . .Blue Micro 5" Flex Boning
55546513 . .Blue Micro 6" Boning



55546520 . .Blue Micro 8" Chef's Knife
55546521 . .Blue Micro 10" Chef's Knife



55546521 . .Blue Micro 10" Slicer, Serrated



55546602 . .Blue Micro 3-1/2" Paring, Serrated



55546549 . .Blue Micro 8" Bread Knife



55546619 . .Blue Micro 6" Stiff Fillet



**WOOD HANDLE
FLEXIBLE TURNERS**
 55524003Solid 14-1/2"
 55524007Perf 14-1/2"
 55524004Solid 19-3/4"
 55524008Perf 19-3/4"



STAINLESS PANCAKE TURNER
 Made of #400-series stainless steel, 14-1/4" long.
 45000404Slotted Blade
 45000Solid Blade



WOOD HANDLE UTENSILS
 5552401010-1/2" Pie Server
 555240117-1/2" Spreader



HAMBURGER TURNER
 Riveted wood handle, 3"
 wide s/s blade
 450313011"



SANDWICH KNIFE
 White plastic handle,
 6" blade.
 55527393



PLASTIC SPREADER
 Sturdy, lightweight spatula
 and spreader.
 555092507-3/4"



**PLASTIC HANDLE
PARING KNIVES**
 53010506Yellow 3.25"
 53010507Yellow Serrated 3.25"



BREAD KNIVES
 ABS plastic handle, serrated blade.
 555240378-1/2"
 5406006210"



SOFT TOUCH PARING KNIFE
 Contoured plastic handle and 3-1/2" blade.
 55500602



WOOD HANDLE KITCHEN FORKS
 Long-reach, two-tine forks with wooden handles
 5552401213"
 5552401321"



HABAN MARKET SAW
 The standard for meat cutting, with nickel-
 chrome plated 25" blade, 31" overall length.
 60601013.....Haban #6050 Saw
 60601014.....Blades only

Kitchen Brushes



SPARTA® BASTING BRUSHES

Bristles are molded into handle to prevent contamination, molded hooked-handle hangs on crocks and pots.

8084342 2" Boar Bristle

8084343 3" Boar Bristle

8087542 2" Nylon Bristle

8087543 3" Nylon Bristle



SPARTA® VEGETABLE BRUSH

Classic round lop construction and a straight handle with firm bristles to clean vegetables and produce from all sides.

401649-1/2"



SPARTA® GALAXY™ PASTRY BRUSHES

One-piece smooth handles are easy to clean.

Nylon bristles are epoxy set into epoxy handles to prevent bacteria-harboring air pockets.

80875022"

80875033"

CARLISLE
FoodService Products



SPARTA® PASTRY BRUSHES

Quality lacquered hardwood handles with brown nylon ferrules are durable and attractive. Boar bristles are epoxy set into epoxy handles to prevent bacteria-harboring air pockets.

80843211-1/2" Pastry Brush

80843222" Pastry Brush

80843233" Pastry Brush

8084324" Pastry Brush

8084421" Round Pastry Brush



RAPI-KOOL

Helps stop bacteria growth cold! Rapi-Kool offers a fast, easy way to help chill cooked stews, soups and chili safely and within the time limit mandated by the FDA and boards of health.

- Chills in the most effective way-"inside out"
- Complements & speeds outside-in cooling
- Easy to use-simply fill the tap water, freeze, insert and stir
- Rapi-Kool is NSF certified
- It's the cost-effective way to cool stew, soup, Chili, sauces
- Smooth exterior allows for easy removal of chilled foods, reduces waste

55511910Rapid Kool 64 oz.

55511911Rapid Kool 128 oz.



KLEEN-PAIL

Meets HACCP "dedicated use" mandate. Kleen-Pail helps you overcome an age-old problem in foodservice-using the same container for food and dangerous non-food purposes!

- Reduces risk of serious cross-contamination
- Available in red for sanitizing solutions, green for soap solutions

55560088 Quart Red Kleen Pail

55560036 Quart Red Kleen Pail

555060036 Quart Green Kleen Pail

**H HAZARD
A ANALYSIS
C CRITICAL
C CONTROL
P POINTS**

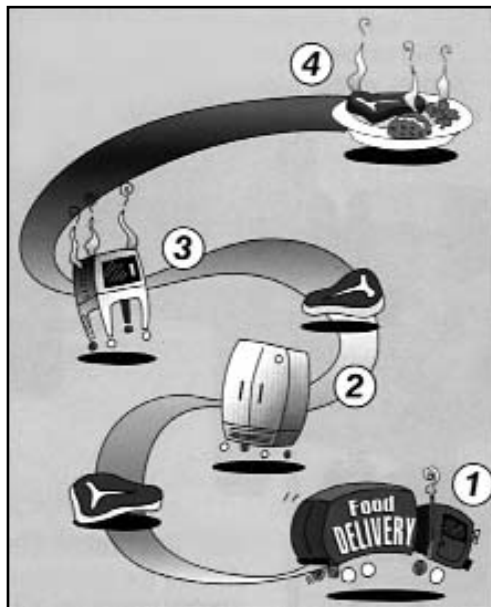

**FROM PURCHASE & RECEIVING (1);
TO STORAGE (2);
TO PREP & COOKING (3);
TO TABLETOP (4) -**

FOOD SAFETY IS ESSENTIAL TO YOUR BUSINESS!

Reduce risk of foodborne illness; increase profitability;
Improve overall employee attitude;
Higher food inspection scores; Enhance customer image.
Ask your RESCO representative for more information.

**KEEP YOUR FOOD & BEVERAGES SAFE
AND YOUR CUSTOMERS COMING BACK!**

Kitchen Supplies



KENKUT II® DISPENSER

Safety and sanitation dispenser for plastic film and foil. Safety blade reduces chances of injury and eliminates cross contamination from unsanitary cardboard cutter boxes.
55520300KK2 White for 12" roll



DYNAMIC SALAD SPINNER

Made of resilient alimentary plastic, 20 liter capacity.
60605010.....19.6 H x 16.9" Dia.

TOMLINSON NO-DRIP® FAUCETS

Faucets for dispensing a wide variety of beverages. No-Drip® faucets are the choice of beverage container manufacturers around the world.
55510722SPRH Tomlinson Faucet Assembly
55510723SPBT Tomlinson Faucet Compl.



ORDER RACK

Keep checks neatly arranged with this easy-in, easy-out, deluxe ball-bearing action rail. Can be mounted with screws, magnetic strips or adhesive tape. Heavy duty aluminum with clear satin anodized finish.

5550108118"
5550108224"
5550108436"
5550108548"



CHECK SPINDLE

55502721



ORDER WHEEL

Stainless steel and chrome with riveted springs to firmly hold checks. Can be ceiling mounted, wall mounted or pedestal mounted.

5551156012" Wheel
5551156117" Wheel
5551156221" Wheel
555115646" Pedestal
5551156510" Pedestal



BROILER BRUSHES

Cleans charbroilers quickly and easily. Ergonomically designed pistol grip prevents fatigue.
59001024Coarse Brush
59001025Medium Brush
59001026Coarse Repl.
59001027Medium Repl.

REDI-GRIL® SCRAPER

Increases food product yield by keeping grill clean and preventing patties from sticking. Prevents burnt food and buildup which ruin grills. Blades are easy to remove without tools. Disposable and resharpenable blades available. Dishwasher safe.

59001016RediGrill Scraper
59001017Repl. Blade





DISHRACKS

Ask your RESCO rep about the many racks, rack accessories and combinations available to create an efficient warewashing and storage system to fit your establishment's needs.

- 65010203Open Cup/Bowl Dish Rack.....P3303
- 6501020716 Compartment Cup Rack.....P4923
- 65010210Silverware Dish RackP6200
- 6501021425 Compartment Glass RackP8023
- 6501021636 Compartment Glass RackP8222
- 6501021736 Compartment Glass RackP8223
- 6501021836 Compartment Glass RackP8224
- 6501022036 Compartment Stemware RackP8244
- 6501022225 Compartment Glass RackP8024
- 6501022425 Compartment Glass RackP8044
- 650103108 Compartment Silverware Rack.....215
- 6501031112 Compartment Silverware Rack....216
- 650232.....Dish Rack Dolly

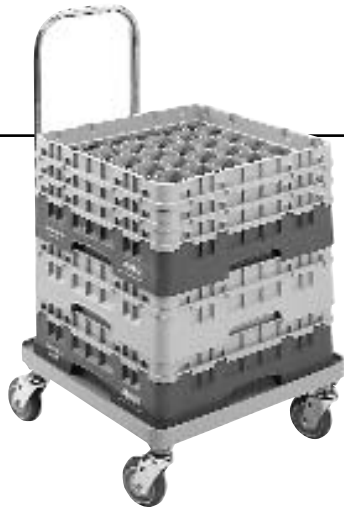
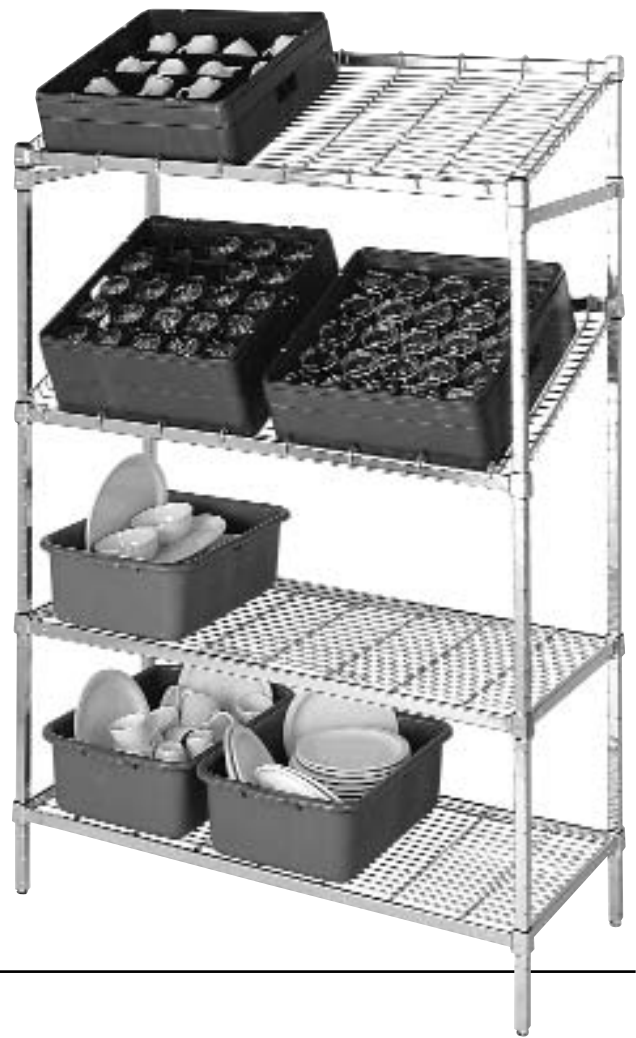

CAMBRO GLASS KEEPERS

Organize your storage area with Cambro Glass Keepers. Available in either fiberglass or economical regal plastic. They are lightweight, compact, easy to use and hold 20 glasses per layer. Dishwasher safe, they feature raised ribs for easy draining and drying.

CAMBRO CUP KEEPERS

Available in either fiberglass or regal plastic, these handy organizers hold 12 cups per layer. Safe, sanitary, stackable and transportable. Dishwasher safe and stain, acid and odor resistant.

50502137Glass Saver Rack - Regal Plastic

50502139Cup Saver Rack - Regal Plastic





AFTER DINNER MINTS

We carry an assortment of candy and treats for your patrons.

- 50601750Starlight Pinwheel Candy
- 50601752Fruit Stars Candy
- 50601755Starlight Chocolate Mint Candy
- 50601762Strawberry Bon Candy
- 50601766Fancy Filled Candy
- 50601772Bon Bon Assortment

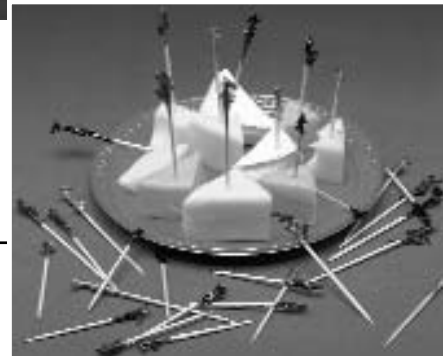

TOOTHPICK DISPENSERS

Available in stainless steel, for round toothpicks, 4.5" high.

- 55511000Stainless steel

TOOTHPICKS

- 505460013" Sword Pick (1M/pk)
- 54001133Frill Picks 2.5"
- 54001134Frill Picks 4"
- 50501109Round Toothpicks
- 50501113Toothpick, Individual Cello Wrap Plain
- 505401.....Single Wrap Mint Toothpick



ACRYLIC TOOTHPICK DISPENSER

Smoke and clear color, holds toothpicks up to 2-5/8".

- 555850313-1/2 x 2-3/4 x 4"
- 570309403-3/4 x 3-1/2 x 5"



BAMBOO SKEWERS

- 505740116" Skewers
- 505740218" Skewers
- 5057403110" Skewers
- 5057404112" Skewers



POP-UP TOOTHPICK DISPENSER

Plastic pop-up dispenser measures 4 x 2-1/2 x 1-7/8", white.

- 55555



DINE-A-WIPE

- 8082941913"x19" unfolded



SWORDS & ARROW PICKS

- 505460013" Sword Pick (1M/pk)
- 50546003Arrow Picks (1M/pk)

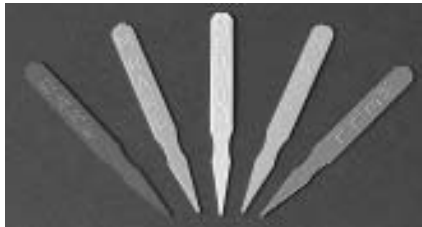

PLASTIC STEAK MARKERS

- 50546021 "RARE"
- 50546023 "MEDIUM RARE"
- 50546025 "MEDIUM"
- 50546027 "MEDIUM WELL"
- 50546029 "WELL"



- DISPOSABLE VINYL GLOVES**
- 50518010Small
 - 50518011Medium
 - 50518012Large
 - 50518013X-Large

Hand contact with Ready-To-Eat foods is a **Critical Control Point** in preventing contamination. In combination with proper hand washing, the proper use of high-quality disposable gloves provides complete barrier protection between hands and food.



- DISPOSABLE PLASTIC GLOVES**
- 50501010Small
 - 50501011Medium
 - 50501012Large



QUICKFIT™ DISPENSING POLY GLOVES

Unique glove design and dispensing system enable quick one-handed donning. Ideal for tasks that require glove changing in a fast-paced environment.

- 50590100QuickFit Dispensing Rack
- 50590101QuickFit Poly Glove - Right
- 50590102QuickFit Poly Glove - Left
- 50590103QuickFit Elbow Length Poly Gloves



DISPOSABLE LATEX INDUSTRIAL GLOVES

Highest quality for maximum finger sensitivity and dexterity. Powder free, with seamless construction. Chemical resistant.

- 505901.....Small
- 505902.....Medium
- 505903.....Large
- 505904.....X-Large



FOODHANDLER™ CLASSIC VINYL GLOVES

The highest quality smooth vinyl gloves, available powder-free. Form fitting and durable.

- 50590108Small
- 50590109Medium
- 50590110Large
- 50590111X-Large
- 50590112FoodHandler Glove Rack



- DISPOSABLE POLY APRON**
- 5050100024 x 42"



- CHEFS' HATS**
- 50501116 10"



- HAIRNET**
- 505103..... Dark Brown

- SANITARY NAPKIN LINER BAG**
- 50577500/case

Paper Products



NAPKINS

- 50500160 . .Econap Cocktail Napkin 9 x 9"
- 50500501 . .Dispenser Napkins 2-1/2 x 6-3/4":

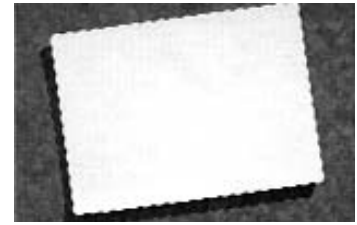

PLACE MATS

- 50500071 . .White, w/Scalloped Edges



50501454



50501456

GUEST CHECKS

- 50501450 . .101 Guest Checks
- 50501454 . .3632 Guest Checks
- 50501456 . .7000 Guest Checks Duplicate
- 50501460 . .G6000 Guest Checks Duplicate
- 50501464 . .4997 4.25 x 9" Tan Guest Checks
- 50501466 . .6997 5 x 9" Tan Guest Checks
- 50501468 . .4797-2 Guest Checks

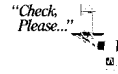

50501468



50501460



50501466



**PARK AVENUE™
ULTRA FACIAL TISSUE**
Fluff out, 2-ply white facial tissue, soft & absorbent in a pop-up box.
50500124



**MAIN STREET
TOILET TISSUE**
1-ply rolls, 4-1/2 x 4-1/2",
1M/roll, 96 rolls/case.
50500125



TOWELS & DISPENSERS

- 50500127C-Fold, 10-1/4 x 13"
24 bundles/125, 3000/case
- 50500126Bleached Multi-Fold,
20/200/case
.....Dispenser, Single Fold,
metal, white enamel
.....Dispenser, Multi & C-Fold,
white plastic



PAPER TABLECLOTHS
5059128.....White Paper, 40" x 300' roll

PARCHMENT PAPER

- 505272.....12-1/8"x16" for baking liners
- 505271.....for Full Size Pans



PAPER PLATES

- 505450006" light weight (250/pkg 1M/case)
- 505450069" light weight (250/pkg 1M/case)



PLASTIC TUMBLERS

- Clear plastic tumblers.
- 505450227 oz squat
(50/bag 1M/case)
- 5054502810 oz squat
(50/bag 1M/case)



SAN JAMAR
Means Quality Dispensers

CUP DISPENSERS

Self adjusting, top loading, gravity or spring-fed dispensers for large cone or flat bottom cups. Made of 26-gauge stainless steel. "P" designation is for "Pull Type", while "EV" designation is for "Elevator" type dispensing.

- 55513720C3200P Cup Dispenser for 6-12 oz.
- 55513721C3400P Cup Dispenser for 12-24 oz.
- 55513722C3500P Cup Dispenser for 32-46 oz.
- 55513723C3200EV Cup Dispenser for 6-12 oz.
- 55513724C3200EV Cup Dispenser for 12-24 oz.
- 55513725C3200EV Cup Dispenser for 32-46 oz.
- 55513727C3400CV Cup Dispenser for 12-24 oz.
- 55513728C3500CV Cup Dispenser for 32-46 oz.



LID ORGANIZERS

- 55513736Small Lid Organizer
- 555137373 Lid Station with Straw



MALT COLLARS

- 55513732Metal, Fits 16oz Cups
- 55513730Plastic, Fits 16oz Cups



EZ-FIT® ONE SIZE FITS ALL CUP DISPENSER

San Jamar's patented EZ-Fit® cup dispenser design accommodates any size of disposable cup effortlessly. The EZ-Fit gasket design works with paper, plastic and foam beverage cups. Made of high-impact plastic.

- Smooth & controlled cup dispensing
- Includes 4 pre-cut gaskets to accommodate 8-46 oz cups, with rim diameters ranging from 2-7/8" to 4-3/4"
- Mounts vertically or horizontally for efficiency

Model #	Cup Size	Rim Dia.	Tube Length
C2410C8-46 oz2-7/8" - 4-3/4"23-1/2"
C2410C188-46 oz2-7/8" - 4-3/4"18"

SAN JAMAR BOX DISPENSERS

Made of 22 gauge 304 stainless steel.

Model #	for Cup Disp. #	Dimensions
C2802(2)C2410C16"h x 8"w x 24"d
C2803(3)C2410C24"h x 8"w x 24"d
C2804(4)C2410C30-1/4"h x 8"w x 24"d
C2803BK...	(2)C2410C16"h x 8"w x 24"d (black box)
C9001(1)C2010C5-1/8"h x 7-1/8"w x 17"d (portion cup)
C9002(2)C2010C10"h x 7-1/8"w x 17"d (portion cup)



DISPENSE-RITE® BOX DISPENSER & LID HOLDER

CTC-C series stainless steel.

Model #	Cup Location	Dimensions
CTC-C-3RSSRight Side25-1/4" h x 13" w x 23" d
CTC-C-3LSSLeft Side25-1/4" h x 13" w x 23" d
CTC-C-4RSSRight Side32-1/4" h x 13" w x 23" d
CTC-C-4LSSLeft Side32-1/4" h x 13" w x 23" d

Disposables



CAN LINERS

- 80803925TM-40 23 x 10 x 39" Heavy
- 80804048RX-483 40 x 47" X-Heavy
- 80804630RX-482 40 x 47" Heavy
- 80804740RX-492 42-1/2 x 49" Heavy
- 80805840RX-602 36 x 55" Heavy
- 80803210RX-331 24 x 33"



ICE BAG

- 80808321IB-10 12 x 21"

PLASTIC BAGS

- 80801013Bread Bag; 5.5 x 4.75 x 15"
- 80801824Utility Bag; 12 x 6 x 24"



COCKTAIL STRAWS

- 505014067.75" Jumbo Stripe Plastic Unwrap Straws
- 505011005.5" Cocktail Stir Straws
- 505011015.25" Black Cocktail Straws
- 505011028" Cocktail Stir Straws
- 505011038" Black Cocktail Stir Straws
- 505013998" Fat Straws
- 505014008" Assorted Neon Straws

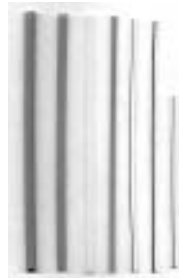

PLASTIC KNIVES FORKS & SPOONS

- 50503100Med. Weight Plastic Spoons
- 50503102Med. Weight Plastic Forks
- 50503104Med. Weight Plastic Knife



SABERT TRAYS

These versatile, disposable trays are proven winners for off-premise catering as well as take-home orders.

- 50503818Marble-look Platter
- 50503250Chrome-look Tray
- 50503550Dome Lid



PANSAVER® BAGS

Hi-temp pan liners, contour fit disposable bags. Why scrub your pans, when all you need to do is sanitize?

- 50542501for Full Pans, 2-1/2" deep
- 50542579for 1/3 & 1/4 Pans



ALUMINUM FOIL ROLLS

Select rolls of foil to meet your needs. Packaged in a cutter-edge box.

- 505712.....Aluminum Foil 12" x 1000'
- 505717.....Aluminum Foil 18" x 1000'
- 505718.....Aluminum Foil 18" x 500'
- 505728.....Aluminum Foil 18" x 500' HD
- 505773.....Aluminum Foil Sheet 9" x 10-3/4"



VINYL FOOD SERVICE FILM

Transparent film designed for heavy duty use in commercial kitchens. Excellent self-cling abilities, tasteless and odorless.

- 505422.....12" x 2000' Vinyl Wrap
- 505428.....18" x 2000' Vinyl Wrap



**SMARTLOCK® HINGED
FOAM CONTAINER**

505013179" 1-Compartment
505013169" 3-Compartment



CATERWARE® TRAYS, BOWLS & LIDS

Glossy black, high-impact trays provide optimal support and an upscale appearance at a very affordable price point. Clear SmartLock® dome lids offer a contemporary design with a great view of the food.

5054412112" Black Serving Tray 505441616" Black Serving Tray
505441212" Dome Cover 505441616" Dome Cover
50500099" Black Foam Plate
5050973510-1/4" Black Foam Plate



CHINET PLASTIC BOWLS & PLATES

505814055 oz Black Plastic Bowl
505814077" Black Plastic Plate
505814099" Black Plastic Plate
5058141010-1/4" Black Plastic Plate
5058141212" Black Plastic Bowl
5058141616" Black Plastic Bowl

FILTERMAGIC FRYMASTER FILTER PAPER

505011408030170 FM-A 25-1/2 x 16-1/2"
505011418030003 FM-A 12-1/2 x 17-1/2"
505011428030171 FM-B 33-1/4 x 21"

DEAN FILTER PAPER

505011508030283 MF90-65 11 x 22-5/8"

PITCO FILTER PAPER

60602007PP10613 Envelope 18-1/2 x 20-1/2"
UFM14/AFM18

HAND FILTERS

5050111810" Dia Filter Cone
50501119Filter Cone Holder Frame



MIROIL HAND FILTERS

55502655BFIA Holder Frame 9 x 22-1/2"
55512748RBZZF 12748 A: 11" B: 9" C: 4-1/2" (40lb Fryer)
55512751RB5FS 12751 A: 11" B: 9" C: 6-1/2" (80lb Fryer)
55512852RB6PS EZFLO A: 11" B: 9" C: 7" (80lb Fryer)

FILTER POWDER

55540424 . .P36B Miroil Life Oil Treatment 72/cs
55540302 . .L106 Miroil Life Oil Treatment 2 gal/box
55571000 . .Maguisol Oil Treatment 40#/cs
55554321 . .Anets Filter Powder 50#/cs

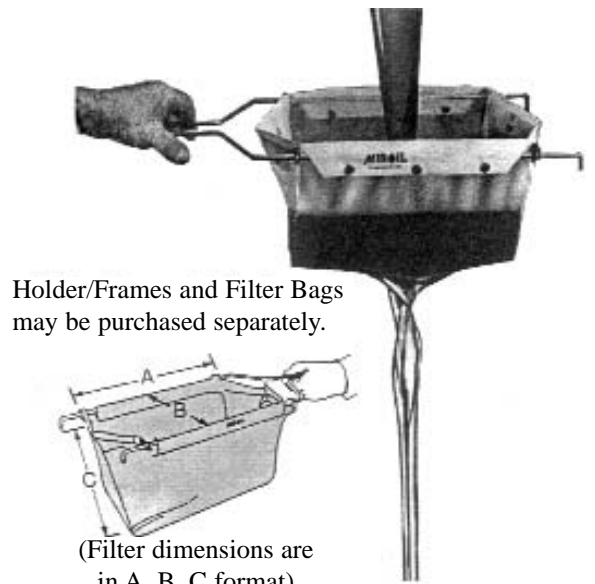

Holder/Frames and Filter Bags may be purchased separately.

(Filter dimensions are in A, B, C format)



COFFEE FILTERS

50598000 . .Coffee Filters 1M/cs

SAN-EZE I® GREASE-PROOF MATTING

Our top-of-the-line grease-proof mat.

- Thickness: 7/8"
- Superior foot comfort
- 100% grease & oil proof
- Sure traction in wet or greasy areas
- Heavy-duty rubber

55511764San-Eze II Brick Red Mat

SAN-EZE® GREASE-RESISTANT MATTING

A heavy duty grease-resistant mat

- Thickness: 7/8"
- Superior foot comfort
- 100% grease & oil proof
- Sure traction in wet or greasy areas
- Heavy-duty rubber

5551175039" x 58-1/2" Black Mat

5551175239" x 29-1/2" Black Mat

55511754Black Connecting Link

55511756Black Bevel Edge 58-1/2"

55511758Black Bevel Edge 29-1/2"

55511760Black Bevel Edge 39"

TEK-TOUGH® ANTI-FATIGUE MATTING

An outstanding anti-fatigue mat

- Thickness: 7/8"
- Heavy-duty rubber
- Excellent foot comfort
- Excellent drainage capability

555117623 x 5' Black

55511763Mat Connector

TEK-TOUGH JR.®

Lightweight anti-fatigue matting with built-in beveled edge.

- Thickness: 1/2"
- Lightweight design
- Built-in beveled edge
- Available in red, grey and black
- Mat connectors available
- Also available in rolls

555117653 x 5' Black Mat

555117663 x 5' Red Mat



80800700

BEAM OVEN CLEANER

Recommended for cleaning grills, ovens, warming ovens, fryers, griddles, canopies, exhaust fans, s/s counters, toasters and coffee urns. Removes rust on steel and chrome.

CLEANTECH® HAND CLEANING SYSTEM

CHG 2% HAND CLEANSER

Chlorhexidine Gluconate 2% - Because of the superior cleaning properties of CHG, it is the most popular solution used in CleanTech® hand washing systems to meet HACCP guidelines.

8081CHG 2% Sanitizer (4 gal/cs)



PURELL HAND SANITIZER

Kills germs, yet is gentle on hands even after repeated daily washings. Meets FDA Food Code Hand Sanitizer guidelines.

80896528 oz Pump Bottle
8089657Sanitizer, 800 ml cartridge
8089621Sanitizer Dispenser



LAMOTTE TEST STRIPS

Test for chlorine, iodine and quadinary (QAC) chemical sanitizing solutions.

55502948Iodine Test Paper
55502949QAC Test Paper
55504250Chlorine Test Paper



SWELL SANITIZING TABLETS

USDA accepted sanitizer, pink tablets.

80828100100 ct/btl



T-SAN SANITIZER

Liquid sanitizer and disinfectant.

80810506/1 gal



CARBON KLEAN

Removes baked-on carbon and grease from metal surfaces without scrubbing.

808130024/1 qt



SOKOFF GRILL CLEANER

For pots, pans, grills, ovens, and all metal surfaces. Removes baked-on grease and carbon

808116254/1 gal



SHEILA SHINE

The best cleaner / polish and surface preservative for stainless steel. Requires no rubbing or polishing. Its is so easy, so simple that it actually makes cleaning a pleasure, with unbelievable results. Sheila Shine prevents liquid penetration, eliminates streaking and resists finger marks. Great for formica, porcelain, fiberglass, enamel, plastic, leather, furniture, etc.

80801010 oz aerosol

8080204 gal/cs



BRUSHES

808113228" Palmyra Bristle Scrub Brush
808113218" Poly Bristle Scrub Brush
808113208" Wok Brush Bassine
8081134225" Handle Urn Rod Brush
8081134610" Curved Coffee Urn Brush
8081134830" Handle w/Oval Poly Bristles
8081135612" Handle Pint Bottle Brush
8083585-1/2 x 7-1/2" Tank & Kettle Brush
808415Kettle Drain Brush
80811354Toilet Brush
808408Crumb Sweeper

HI-LO SCRUBBER
80838

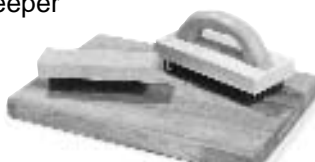

BUTCHER BLOCK BRUSH
Wooden 4 x 9" block with handle & flat steel bristles
80811371



NYLON HANDLE POT BRUSHES

808113238" Brush (black bristle)
8081132220" Brush (white bristle)



VEGETABLE BRUSH
40164



BROILER BRUSH
808423



COUNTER BRUSH
80811336



RUBBER HOSE & NOZZLE

Heavy duty red rubber hose, 50 ft x 5/8" ID, specially constructed for hot water use. Abrasion resistant, with heavy duty brass couplings.

- 5551173050 Foot (Red) Hot
- 55511731Insulated Spray Nozzle



NEOTEX PROTECTIVE MESH

Protects glassware, reduces noise level, promotes sanitation.

- 55530701Green Neotex Matting
- 55530703Red Neotex Matting
- 55530705Almond Neotex Matting
- 55530707Black Neotex Matting



CORRUGATED MATTING

Made of non-conductive rubber with cotton fabric inserts non-skid bottom and corrugated top. 36" wide roll. 8087112.....1/8" thick

DECK MOUNT FAUCETS

COMPONENT HARDWARE GROUP

WALL MOUNT FAUCETS



TOP-LINE FAUCETS

With swing spouts

- 91600103K11-4012 12" Deck Mount Faucet Spout
- 91600106K13-8012 12" Wall Mount Faucet Spout



DRAINS & BASKETS

- A. 91600125.....102-1064 Strainer Basket
- B. 91600126.....102-1063 Drain Basket Only



WATER WAND AUTOMATIC FAUCET CONTROL

Sanitary, fast, hands-free water demand, since food particles can stick to faucet handles causing bacteria and germs. 91600050



DORMONT GAS CONNECTORS

Dormont invented the Supr-Safe quick-disconnect gas appliance connector which allows foodservice equipment to be mounted on casters for mobility, and safely connected to gas service.

- 96916103616100NPFS36 1" Gas Hose
- 9691675361675NPFS36 3/4" Gas Hose
- 9869167548...1675KIT48 3/4" Flex Hose Kit
- 96916755016100KIT48 1" Flex Hose Kit





PRE RINSE UNITS

All pre-rinse units equipped with internal spring checks to prevent cross flow.

- 909010014" Center Deck Faucet: B-0113
- 909010038" Center Deck Faucet: B-0133CC
- 90901025B-0107 Pre-Rinse Spray Valve
- 90901031B-10K Repair Kit for 9090125
- 90901028B-0044-H2A Pre-Rinse Hose
- 90901029B-0044-H Flex Hose with Handle
- 90901030B-0068H Pre-Rinse Flex Hose
- 90901023B-0156 Add on Faucet 12"



BIG-FLO FAUCET

Delivers high volume of water for pot sinks & kettles.

- 90901014B-0290 Faucet 8" Centers



WORKBOARD BAR SINK FAUCETS

With swivel spout.

- 90901016B-1122 10" Deck Mount
- 90901017B-1128 12" Wall Mount



90901018



90901019

PUSH-BACK GLASS FILLERS

Wall Mounted with volume regulator.

- 90901018B-1200 3/8" IPS Female Inlet
- 90901019B-1205 3/8" IPS Male Inlet



PEDESTAL PUSH-BACK GLASS FILLERS

Single pedestal with volume regulator.

- 90901020 . .B-1210, 12"
- 90901022 . .B-1210, 9"



WATER STATION

With 8" pedestal filler and 10-1/2" x 12-1/2" drip tray.

- 90901021B-1230 Water Station
- 90901064Blue Lexan Filler Faucet Arm



90901013

SINK & PANTRY FAUCETS

- 90901010B-0201 Swivel Faucet w/ 12" Nozzle/ Base Mount
- 90901012B-0231CC Swivel Faucet w/ 12" Nozzle/ Wall Mount
- 90901013B-0210LN Base Faucet Only



90901012



90901010



2,000 HOUR INCANDESCENT BULBS

Lasting twice as long as standard light bulbs, these 2,000 hour bulbs provide savings on maintenance and labor costs.

- 505800124 ft. Tube Shield Bi Pin
- 505800138 ft. Single Tube Shield Pin
- 50580014BiPin End Cap Only
- 50580015Single Pin End Cap Only
- 5058001860 Watt Ultraguard Light
- 50580019100 Watt Ultraguard Light



HEAT LAMP BULBS

These 250 watt reflector type heat lamp bulbs last an average of 5,000 hours - twice as long as standard bulbs.

- 55511745Red Heat Lamp Bulb
- 55511746White Heat Lamp Bulb
- 55511747Red Shat-R-Guard Bulb
- 55511748White Shat-R-Guard Bulb



OVERFLOW STAND PIPES

Dual rubber seals provide a positive seal when placed in a drain. Durable white plastic.

- 9131338for 1" NPS drains
- 9131339for 1-1/2" NPS Drains



URINAL SCREEN
80800165



CANOPY GLOBE COVER

Tempered glass globe is thermal and shock resistant and plastic coated.

- 91650011L50-X011



BUCKET OPENER

Opens buckets and cans, cuts through lid flanges.

- 5551421441



ICE SCOOP HOLDER

White epoxy coated steel with 3-5/8 x 6-1/2" opening.

- 555601



WOBBLE WEDGE

Levels table legs securely.

- 55528074Pack

BROOM HOLDER W/SHELF

34", not shown

- 8083336



4-CLIP MOP

BROOM HOLDER

Organize your closet with this 2' stainless steel holder.

- 5550334



HEAVY NITRILE GLOVES

Green heavy duty gloves, 18" long.

- 80817300Large
- 80817301X-Large



METAL TRAY STANDS

Durable folding stands made of 20 ga. tubular steel, prevent tipping of trays.

- 80876000Chrome
- 80876001Coffee



LOBBY DUST PANS

Hooded dust pans.

- 808304Metal
- 5802007Plastic



8086



5802006



8083012

DUST PANS

- 8083012Metal
- 5802006Plastic
- 8086Metal



KLEEN PAIL

Promotes cleanliness and food safety. Higher capacity accommodates 1oz sanitizing packets. More durable base pail with measurement marks for accurate mixing. Unique spout makes pouring easier.
 5556003.....6 qt. Red
 5556008.....8 qt. Red
 555060036 qt. Green



SAFE-T-ICE SCOOP

Scoop design prevents hand contact with ice or other foods during use. Guardian isolates the scoop from the ice or other foods preventing contamination. Unique patent pending design enhances beverage station or bar appearance.
 5556001

SAFE-T-ICE TOTE

Dedicated container to help avoid cross-contamination. Improved, softer handle for easier carrying. Clear blue durable plastic assures clean ice.
 5556000



AIR CARE METERED DEODORIZERS

The hard work and expense it takes for janitorial maintenance should not be squandered due to residual foul odors Air care is not about supplemental niceties - it is a necessity.
 80811636Wild Berry Patch deodorizer
 80811638Cinna Fresh deodorizer
 80811632Metered Insecticide



OPTIPURE™ TOTAL WATER TREATMENT RESOURCE

- Filtration Systems
- Softening Systems
- Membrane Separation Systems
- Replacement Cartridges
- Technical Support
- Fountain Beverages
- Ice Machines
- Coffee & Tea
- Espresso
- Steam Equipment



Filter Cartridges



60607011



60607012



60607003

Here are our In-Stock Ice Machine Systems:

- 60607011.....FXI-11 for up to 450 lb. Cubers & 800 lb. Flakers
- 60607014.....Replacement Cartridge for FXI-11
- 60607012.....FXI-12 for up to 1000 lb. Cubers & 1600 lb. Flakers
- 60607003.....FXI-22P for over 1000 lb. Cubers & up to 3200 lb. Flakers
- 60607015.....Replacement Cartridge for FXI-12 & FXI-22P

Ask your RESCO representative about all your water system needs.



YOU KNOW YOUR BUSINESS VERY WELL -

AND WE KNOW OURS.

DiverseyLever has a long track record of fulfilling the hygiene needs of the restaurant industry throughout the world. Now, we have focused our resources and expertise into a specialist restaurant program, which offers the best of our products and systems to provide you with complete solutions that enhance and maintain your restaurant image.



DIVERSEY DISHWASHING

- 80846083Zerospot (5 Gallon. Pail)
- 80846084Zeros Spot (4/1 Gallon. Case)
- 80846342Low Temp Suds Lx24 (5 Gallon)
- 80846237Advance Rinse Hard (5 Gallon)
- 80846250Advance Pink Pot & Pan (4/1 Gallon)
- 80846372Advance Rinse Hard (4/1 Gallon)
- 80846000Suma Advantage Dishwashing
- 80846002Suma Diverpak Encap. Machine Dishwash
- 80846056Suma Rinse (5 Gallon Pail)
- 80846057Suma Rinse (4/1 Gallon Case)
- 80846042Suma Dip (4/1 Gallon)
- 80846176Le Drying Agent (5 Gallon Pail)
- 80846177Le Sanitizer (5 Gallon Pail)
- 80846314Suma light (4/1 Gallon cs)
- 80846324Liqua-Klor (4/1 Gallon cs)
- 80846067Suma Klear (5 Gallon Pail)
- 80846065Suma Klear (4/1 Gallon cs)
- 80846066Suma Ultra (5 Gallon Pail)
- 80846076Suma Utra (4/1 Gallon CS)



DIVERSEY FLOOR & CARPET CARE

- 80846016Suma Lima Care 4/1 Gallon

DIVERSEY CLEANERS & DISINFECTANTS

- 80846100Suma Grill 4/1 Gallon Case
- 80846105Suma Calc (Acid) 4/1 Gallon
- 80846161Suma Force 4/1 Gallon Case
- 80846304Suma Super (5 Gallon Pail)
- 80846048Suma Super (4/1 Gallon Case)
- 80846338Suma Star (4/1 Gallon)
- 80846344Triax Color Safe Bleach (5 gal)
- 80846386Suma Powder Keg (4/9#)





LAUNDRY POWER PRODUCTS

8080338Envy (50#)

MISCELLANEOUS LAUNDRY PRODUCTS

8080243Rust Buster 16oz (12/16oz)

LAUNDRY DISPENSER PRODUCTS

- 8080238Low Temp Attack Built Detergent (5 gal)
- 8080330Low Temp Attack Built Detergent (15 gal)
- 8080316Low Temp Breitway Oxygenated Bleach (5 gal)
- 8080331Low Temp Breitway Oxygenated Bleach (15 gal)
- 8080277Extra Detergent (5 gal)
- 8080244Low TempNeutro Sour Neutralizer (5 gal)
- 8080246Low Temp Soft & Fresh Fabric Softener (5 gal)
- 8080322Super Conditioner (5 gal)
- 8080323Low Temp Super Sour (5 gal)
- 8080329Low Temp Super Sour (15 gal)
- 8080242Low Temp White Destainer (5 gal)

LOW TEMPERATURE DISHMACHINE PRODUCTS

- 8080218Daisy Low Temp Dishmachine (5 gal)
- 8080219Daisy Low Temp Dishmachine (6/1 gal)
- 8080220Low Temp Rinse (5 gal)
- 8080221Low Temp Rinse (6/1 gal)
- 8080222Pure Low Temp Sanitizer (5 gal)
- 8080216Sequestar Low Temp Dishmachine (5 gal)

LIQUID DISHMACHINE DETERGENTS

- 8080214Star Dishmachine Detergent (5 gal)
- 8080257Star Dish Detergent (6/1 gal)
- 8080306Star Plus Liquid Compound (5 gal)

POWDER DISHMACHINE DETERGENTS

- 8080268Compact Condensed Detergent (4/9#)
- 8080270Powder/2 Condensed Detergent (4/9#)
- 8080294Quantum Condensed Detergent (4/9#)
- 8080308Strike Chlorinated Compound (4/9#)

RINSE ADDITIVES

- 8080248Whiz Dry Rinse Additive (5 gal)
- 8080251Everdry (Whiz HA) Rinse Agent (5 gal)
- 8080252All Dry Rinse Additive (5 gal)
- 8080253All Dry Rinse Additive (6/1 gal)
- 8080263Everdry (6/1 Gallon) (Whiz HA) Rinse Agent

MISCELLANEOUS KITCHEN PRODUCTS

- 80802353D Descaler (6/1 gal)
- 8080262CB Special Glass Machine Detergent (4/8#)
- 8080209Culture Chock Enzymatic Drain Cleaner (5 gal)
- 8080210Culture Chock Enzymatic Drain Cleaner (6/1 gal)
- 8080276Expert Solid Silverware Pre-Soak (4/6#)
- 8080226Gone Pot & Pan Det (6/1 gal)
- 8080227Gone Pot & Pan Det (6 gal)
- 8080280Grease Kicker H.D. Detergent (6/1 gal)
- 8080285Oven & Grill Cleaner (6/1 gal)
- 8080296Quick Liquid Pot Pan Hand Washing Det. (5 gal)
- 8080297Quick Liquid Hand Washing Detergent (6/1 gal)
- 8080300Scalex Dishmachine Scale Remover (6/1 gal)
- 8080224Silverbrite Silverware (4/8#)
- 8080328Lemon Pot & Pan Detergent (5 gal)



Mt. Hood Chemical Corporation

PRESSURE WASH/ALL-PURPOSE/STEAM CLEANERS

- 8080228Formula 561 Floor Degreaser (6/1 gal)
- 8080229Formula 561 Floor Degreaser (5 gal)
- 8080230Crusader All-Purpose (6/1 gal)
- 8080231Crusader All-Purpose (5 gal)

AIR FRESHENERS

- 8080241Green Apple Aerosol (12/10 oz)
- 8080239Cor-Air Freshener Dispenser (12/10oz)

HAND SOAPS/SHAMPOO

- 8080234Elegance Pearlized Lotion Hand Soap (6/1 gal)
- 8080327Mt. Hood Liquid Soap (6/1 gal)
- 8080208Ultra Hand Cleaner Antimicrobial (6/1 gal)
- 8080237Impact Dispenser for Hand Soap

HOUSEKEEPING PRODUCTS

- 8080200Amazing Tub and Tile Cleaner
- 8080201Amazing Shower, Tub & Tile Cleaner
- 8080212Crystal Glass Cleaner
- 8080287New Bowl Mt Hood (12/32 oz)

INDUSTRIAL LIQUID

- 8080247Lubricon Conveyor

AEROSOLS

- 8080261Bug Away (12/18 oz)
- 8080317C-Thru Glass Cleaner (12/18 oz)
- 8080291Gleem Furniture Polisher (12/16.5 oz)
- 8080284Oven Ex Aerosol Oven Cleaner (12/19 oz)
- 8080318Steel Glo (12/19 oz)

DISINFECTANT PRODUCTS

- 8080236Now Sanitizer Deodorizer
- 8080332Lemon Crush All-Purpose Deodorizer
- 8080319MHBC Toilet Bowl Cleaner

BOTTLES, SPRAYERS & PUMPS

- 8080237Impact Dispenser for Hand Soap



Mt. Hood Chemical Corporation



ROUN' TOP RECEPTACLE

With no metal parts, these containers are safe and secure for hospitals and prison systems, designed to extinguish a fire.

5551305.....18 Gal. Beige



SANITARY NAPKIN DISPENSER

Floor model, 9" x 9" x 11-1/4h, White. 5552211



ROUND HUSKEES

- 5802609.....10 Gal. Grey Lid
- 5802609110 Gal. White Lid
- 5802610.....10 Gal. Grey Container
- 5802610110 Gal. White Container
- 5802619.....20 Gal. Grey Lid
- 5802619120 Gal. White Lid
- 5802620.....20 Gal. Waste Container
- 5802620120 Gal. White Container
- 5802631.....32 Gal. Grey Lid
- 5802631132 Gal. White Lid
- 5802632.....32 Gal. Grey Container
- 5802632132 Gal. White Container
- 5802643.....44 Gal. Grey Container
- 5802643144 Gal. White Container
- 5802645.....44 Gal. Grey Lid
- 5802654.....55 Gal. Grey Lid
- 5802655.....55 Gal. Grey Container
- 5802640.....Round Dolly



HUSKEE CONTAINERS

Molded of engineered resins with seamless construction, the Huskee is a strong, long-lasting receptacle. Stackable with lid on, nesting with lid off.

KING KAN

These containers are molded of structural plastic with UV inhibitors, confidently used for indoor or outdoor applications. Won't dent, crack, chip or warp even under rough conditions. 5808430.....35 Gal. King Kan Container only



PIONEER™ FLOOR URNS

Perfect in lobbies and hallways, firesafe construction and stainless steel container.

- 80816001 Black
- 80816002 Brown

SMOKERS' OASIS

The first affordable, all-steel, aesthetically pleasing, use-anywhere, cigarette butt disposal receptacle.

- 39" high, 16" diameter. Weather proof.
- SRS-1HCCL...hammered charcoal
- SRS-1HGLD ..hammered gold
- SRS-1HCPR ..hammered copper

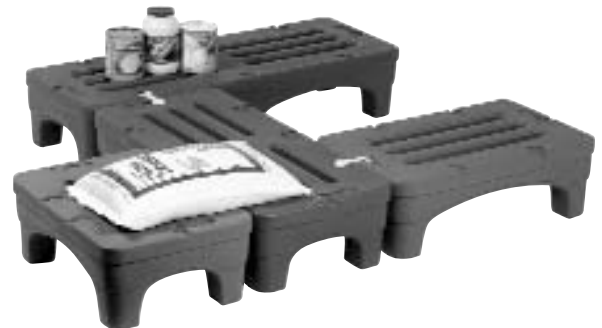

DUNNAGE RACKS

Made of durable polyethylene, these grey racks are the best solution for storage.

- 5553636 x 22 x 12"
- 5554848 x 22 x 12"
- 5556060 x 22 x 12"



WALL HUGGER WASTE BASKETS

Built of durable engineered plastic. These receptacles stand tall in the tightest of spaces. Their sleek, attractive design holds 23 gallons of trash but protrudes less than one foot from the wall. Smooth seamless construction for easy cleaning and prolonged life, standing at 30" tall, these receptacles make for great placement under standard work tables.

5803540.....23 Gal. Grey Base
5802673.....Grey Tip Top Lid



COMMERCIAL PLASTIC WASTE BASKETS

The low profile and sleek, attractive design of these rectangular wastebaskets make them the perfect choice for a variety of applications.

580294744.375 Qt. Grey Round
580295513.625 Qt. Rectangular
580295628.125 Qt. Grey Rectangular
5802956128.125 Qt. Black Rectangular
580295741.25 Qt. Rectangular



HALF ROUND WALL HUGGER

The Half Round completes the popular wall hugger line. Its smaller footprint with an impressive 21 gallon capacity is ideal for today's space efficient workplace.

5803520.....21 Gal. Half Round Grey

SWINGLINE SQUARE WASTE BASKET

Provides 25% more capacity which equates to labor and poly liner savings. The rolled rim provides strength and convenient area to lift or pull. Reinforced base will take rough commercial use and you can nest for easy storage.

580356925 Gal. Grey



ALL PURPOSE WET MOP HEADS

DuraPro® mop head, 4-ply cotton, 1" headband, white.

580661116 oz.
580661220 oz.
580661323 oz.
580661432 oz.



LOOPED END WET MOP HEADS

SuperStitch® mop head, 4-ply cotton/synthetic blend, 1" headband, for absorbing spills. Specify color.

5806550Medium
5806553Large



UTILITY WET MOP HEADS

Rough Rider Wet Mop Heads with 1-1/4" headbands, cut-end, t-shirt cotton/blend, white.

5806545Medium
5806548Large



MOP BUCKETS & WRINGERS

5806129Combo Pack 26 qt Bucket w/Side Press Wringer 226-310, yellow
5806126326 qt Bucket w/Splash Guard 226-3, yellow
5806135235 qt Mop Bucket 335-3, yellow
5806121Side Press Wringer SW10, for up to 32 oz mops
5806123 Downward Pressure Wringer SW4, for 24-36 oz mops
58061262Unibody 35 qt. Mop Bucket, yellow



Side Pressure



Downward Pressure



FLOOR SQUEEGEES

Choose black double foam or rubber blades.

Handles sold separately.

- 580929.....30" dual moss flex blade
- 5704567224" straight plated, black double foam
- 8084008118" straight steel, black double foam
- 8084010718" black double foam refill
- 8084008224" straight steel, black double foam
- 8084010824" black double foam refill
- 8082221818 x 2-1/16" straight steel, rubber blade
- 8082221918 x 2-1/16" rubber blade refill
- 8082222424 x 2-1/16" straight steel, rubber blade
- 8082222524 x 2-1/16" rubber blade refill



WINDOW SQUEEGEES

Single blade black rubber squeegees with quick-release channel frame, handle sold separately.

- 8081128012"
- 8081129016"

SPARTA® FLOOR SWEEP PUSH BROOMS

Choose from foam or wood block, with black tampico or palmyra bristles. Handles are sold separately.

- 8081133018", foam block, tampico bristles, med.
- 8081133224", foam block, tampico bristles, med.
- 8081132718", wood block, palmyra bristles, heavy duty



BROOM HANDLES

- 8081131160" threaded nat. wood, 1-1/8" dia.
- 8081131360" tapered nat. wood, 1-1/8" dia.
- 8081130060" lacquered wood, 15/16" dia., metal threads



JANITOR MOP HANDLE
63" wood handle with 7" metal janitor head.

80893



QUICK-CHANGE MOP HANDLE
Stirrur mop stick, 63 x 1 x 7" handle, metal head, black.

- 808937.....steel handle
- 808927.....aluminum handle

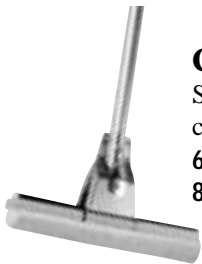

COMBO SPONGE MOP
Steel handle, 55-13/16", with 12-3/4" cellulose fiber sponge. Blue

- 6012Sponge Mop (special order)
- 80806112Sponge Refill



INVADER® MOP HANDLE
Hinged side gate handle allows easy on-off, , 54" long wood w/plastic head for use with 1" headbands only.

55534004



SPARTA® ANGULAR BROOM
Heavy, flagged polypropylene bristles and wood handle, 54"

5806377



LOBBY CORN BROOM
100% corn fiber, brown

5806373



CORN BROOMS
100% natural corn fibers, with stained lacquered wood handle.

- 580638124lb. w/1" dia. hdl.
- 580638435lb. w/1-1/8" dia. hdl.



Counter Equipment



60613004



60613000



60613002

HOLMAN COMPACT CONVEYER TOASTERS

- Patented forced convection keeps the toaster cool to the touch and extends the life of critical components. The forced convection increases productivity by re-circulating pre-heated air into toasting chamber.
- Quartz infrared heaters provide faster, more consistent heating than traditional heating elements.
- 606613004 requires only 14.5" of counter space and our patented forced convection system allows the unit to be placed against a wall. Other toasters have louvers requiring additional counter space.

60613004350 slices per hour120VW14.25" x D18.875" x H13.25"

60613000500 slices per hour120VW14.5" x D22.375" x H15.625"

60613002600 slices per hour208/240VW14.5" x D22.375" x H15.625"



WARING 2 & 4 SLICE TOASTERS

Extra wide 1-3/8" slots for bagels and thickly sliced bread. Self-centering bread rack for thinnest sliced bread. Easy Touch Control and LED Indicators. Defrost-defrosts bread before toasting. Reheat-reheats without browning.. Cancel-interrupts toasting, returns carriage to top position. Rotary dial browning level control. Quick-clean pullout crumb tray. 120 VAC, 60 Hz

5557022-Slice Toaster, WCT702

5557044-Slice Toaster, WCT704



2 SLICE BAGEL SMART® TOASTER FROM PROCTOR SILEX

Auto shutoff. Extra-wide slots. New, attractive styling SmartToast® thermostat. Self-adjusting bread guides. Snap-open crumb tray. Full-range shade selecton. 900 watts 120V/AC only

55543002-Slice Toaster, 22225



HOBART 4-SLICE TOASTER

Up to 400 slices/hour. Solid state electronic controls adjust toast time, stainless steel construction for heavy duty restaurant use. Removeable crumb tray. 120/208/240VAC 3-pole, without cordset.

606410564-Slice Toaster, ET26-4



CADCO MICA 4-SLOT STANDARD TOASTER

- Stainless steel/ metallic grey finish
 - Heavy duty KoverTec™ mica elements with 2 year warranty
 - 1" x 5" x 5" slots
 - Selector switch for 2 or 4 slot operation
 - Manual timer control
 - Manual ejector with keep warm feature
 - Pull-out crumb tray for easy cleaning
 - Stainless steel with metallic grey end panels
 - Electrical: 120 volts
- 5553.....Mica 4-Slot Standard Toaster

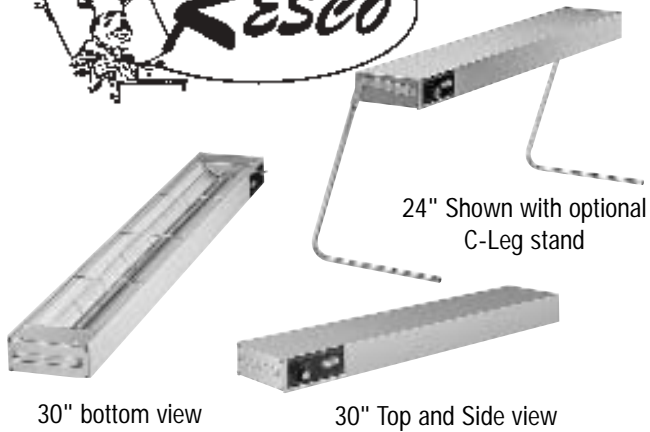

HATCO GLO-RAY INFRARED FOODWARMERS

Keep all hot foods at optimum serving temperatures longer. Foods do not dry out or become discolored; even the most delicate dishes hold that "just-prepared" look. The Glo-Ray pre-focused heat pattern directs heat from a tubular element to bathe the entire holding surface

- Optional breath protectors can be ordered with most aluminum Glo-Ray models and meet NSF standards.
 - The Designer color option helps blend warmers into any decor.
 - On/off switch installs front or back of the unit to suit the location.
 - 115 volts, specify aluminum high watt or aluminum standard watt
- | | | |
|----------|-------------------------------------|----------|
| 60601079 |Hatco Food Warmer, 115 volts | 24" wide |
| 60601080 |Hatco Food Warmer, 115 volts | 36" wide |
| 60601081 |Hatco Food Warmer, 115 volts | 48" wide |
| 60601082 |Hatco Food Warmer, 115 volts | 60" wide |
| 60601083 |Hatco Food Warmer, 115 volts | 72" wide |
| 60601078 |Hatco Adjustable Angle Bracket | |



WELLS FOOD WARMERS

Wet/dry operation, thermostatic controls, s/s construction, 120v, 1ph operation

- 60604001LLW-11, 11qt Round, 650 watt
- 60604002LLWC-11, 11qt Round, 1100 watt
- 60604003LLW-1220, 12 x 20" pan
- 60620130SS-10, 11qt Top-Mount Built In
- MOD-10012 x 20" Top-Mount Built In
- MOD-400(4) 12 x 20" Top-Mount Built In



MERCO SAVORY FREESTANDING 2- BULB WARMER

Keeps cooked foods fresh & appetizing from prep to serving. Aluminum alloy construction. Vented aluminum reflectors w/heavy duty electrical sockets.

- 606010742B2 2-Bulb Food Warmer



HATCO GLO-RAY PORTABLE INFRARED FOODWARMER

• Has a specially designed stand that keeps food holding pans off the work area and allows easy access from three sides. The air space between pan and bottom and counter top serves as an effective insulation to prolong serving life.

- Optional designer colors and accessory food pans and hard coated fry ribbons available
 - Available with heat above the food, below the food or both.
 - Factory pre-wired with a 6' (183 cm) cord and plug.
 - Available with metal sheathed or ceramic elements
 - Optional incandescent lights available to enhance food appeal.
- | | | |
|----------|---------------------------------|----------------------------|
| 60601084 |Hatco Portable Food Warmer | 120V |
| | | W12.375" x D24" x H15.875" |

Counter Equipment



SUPER JETSTAR™ 8 oz POPCORN POPPER

8 oz. nickel-plate kettle for better popping, easier cleaning. Pops 170 one ounce servings per hour. A magnetic catch holds the one piece lid up for easy and safe loading. 120/240V
60686H30.5" x W19.5" x D14.5"



JETSTAR™ 6 oz POPCORN POPPER

Handsome 4 corner post construction stands up to heavy use. Clear tempered glass panels and heavy gauge Plexiglas doors with full length aluminum hinges to provide unobstructed view. Clear lexan serving drop panel provides for great visibility. 120/240V
60639H25.125" x W19.5" x D15.25"



HOT DOG STEAMER

Side-by-side steamer and bun warmer, holds 170 hot dogs & 18 buns, tempered glass doors, juice tray, rugged s/s construction.
60635800W



APW/WYOTT HOT DOG ROLLER GRILL

- Fast recovery
- 2 cooking zones for fast cook & safe hold
- Easy to clean
- Up to 459 dogs per hour!
- Available Drawer-Type Bun Warmer, and Self-Serve Sneeze Guard w/Door

60614005APW HRS31 Hotrod Rolling Grill
60614007SG-31 Sneeze Guard
 spec. order ...BW31 Bun Warmer
 (72 Bun Capacity)



APW/WYOTT 6 – 8 oz CORN POPPER

- Maximum popcorn "burst" and less un-popped kernels
- 1 kettle every 2-1/2 min.
- Up to 130 1 oz. servings per hour
- Easy to operate and maintain
- Stainless steel interiors wipe clean
- Durable S/S cabinet & tempered glass
- Illuminates merchandising sign

6066615325.5"H x 19"W x 15.625"D; 120V



MR. FRANK HOT DOG STEAMER

This innovative design uses less counter space with no loss of production. S/S & tempered glass construction. Holds over 150 dogs, and 60 buns.
DS1A120V, 800W, 6.7 amp

HATCO GLO-RAY® HEATED DISPLAY CABINETS

Illuminated case offers full view tempered glass sides and rollerless sliding doors. Constructed of stainless steel and aluminum for durability and ease of maintenance. Metal sheathed elements heats from above while thermostatically controlled base conducts heat from below.
GRHD-2P2-Pan Case
GRHD-3P3-Pan Case
GRHD-4P4-Pan Case



HATCO FLAV-R-FRESH® IMPULSE DISPLAY CABINETS

Safe and convenient, Hatco humidified, heated Cabinets create impulse sales while ensuring food safety. Prepare and hold the most popular foods in these warmers that utilize controlled moisturized heat to hold product longer.



FDW11-door w/Circle Rack w/Motor
FDW1X1-door w/Multi Purpose Rack w/o Motor
FDW22-door w/Circle Rack w/Motor
FDW2X2-door w/Multi Purpose Rack w/o Motor

HATCO FREESTANDING DRAWER WARMERS

Available in 1, 2, 3, and 4 drawer freestanding models built of rugged stainless steel with durable nylon rollers, 12 ga. stainless steel slides and heavy duty hardware. Each drawer thermostatically has recessed on/off switch, thermostatically controlled
HDW11-Drawer **HDW2**2-Drawer
HDW33-Drawer **HDW4**4-Drawer



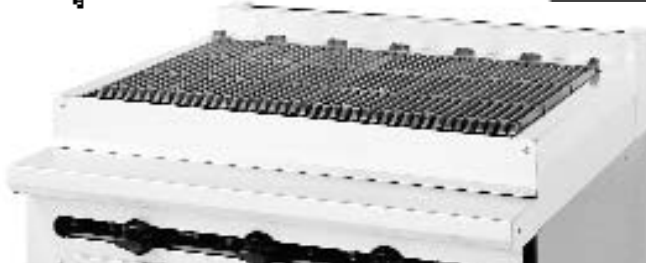

Can be Counter-Top or Range Mounted!

WOLF SUPER CHARBROILERS

Innovative design with finned cast alloy radiants that produce infrared rays to seal in the juices. Steaks, chops, hamburgers and seafoods have a delicious, charcoal-broiled flavor! Plus: Flame-Arrestor grates with cast-in pitched grease trough on each blade; automatic burner lighting; individually controlled direct action burners; reflector baffle under each burner which creates a "cool zone" in the grease drawer. Counter models are 27-1/4" deep in seven widths: 25", 30", 36", 47", 60", 72" and 84".

6065102325", SCB25C

6065102536", SCB36C

6065102747", SCB47C



WOLF REGENCY SERIES GRIDDLES

Manually-controlled with 30,000 BTU/hr burners every 12" of width; RTG models are thermostatically-controlled with 27,500 BTU/hr burners.

6065102024", RMG24C

6065101736", RMG36C

6065101848", RMG48C

6065101936", RTG36 Thermostat Control

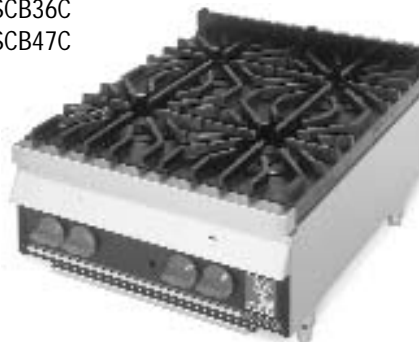

WOLF HEAVY-DUTY HOT PLATES

Designed for versatility and durability! Fit any kitchen need! Match up with all Regency products and are available in eight models in 12", 24", 36" and 48" widths. Standard 30,000 BTU/hr lift-off burners, or choose 2" or 4" step-up rear burners or 11,000 BTU/hr half hot top on rear burner.

606510212-Burner, RHP2-12

606510224-Burner, RHP2-12



APW/WYOTT CLASSIC ROUND FOOD WARMERS

- Heating elements surround sides for even heat distribution.
- Insulated to protect interior parts and countertops from heat build-up.
- Stainless steel housing with stainless steel liner.
- Wet or dry operation.
- Thermostatic control.
- Raised liner edge prevents outside condensation.
- Electric band element provides fast, even heat.
- Uses standard insets and covers.

6060106211 Quart Food Warmer, 120 Volt, 700 Watt

606010637 Quart Food Warmer, 120 Volt, 7500 Watt



APW/WYOTT CLASSIC FOOD WARMER

- Unique "serpentine shaped" heating elements for even heat distribution.
- Insulated to protect interior parts and countertops from heat build-up.
- Wet or dry operation.
- S/S construction excellent durability
- Steel "element support" stabilizes heating elements and reflects heat toward food
- 22 qt. capacity
- 9"H x 14.5"W x 22.5"D
- 120V, 1200W

6065481222 Quart Food Warmer



STAR SOUP KETTLE

This black 11 qt Soup Kettle with the "cast" look, is made of durable spun aluminum for great heat transfer, and s/s bowl & hinged lid

606111000w; 120/240v

Counter Equipment



606024



STAR-MAX LAVA ROCK GAS CHAR-BROILER

- Designed for demanding foodservice applications
- Maximum performance & years of trouble operation.
- High performance 40,000 BTU H-style cast iron burners every 12" of width. Cast iron burners provide excellent performance, better heat distribution & great sectional control.

6066015.....15" Char-Broiler 40,000 BTU
 D25.75" x W15" x H18.875"
 6066024.....24" Char-Broiler 80,000 BTU
 D25.75" x W24" x H18.875"

STAR-MAX GAS HOT PLATE

- Designed for demanding foodservice applications
- Will deliver years of maintenance free operation
- 44,000 BTU- natural or LP gas

606602 ...2-Burner Gas Hot Plate
 H11.9375" x W12.1875" x D28.875"



60614002

APW/ WYOTT COUNTERTOP GAS GRIDDLES

- High output gas burners generate 25% more BTU's
- Fast start-up to prime cooking temperatures
- Fast recovery and the ability to handle load after load of frozen food
- New bull-nose front extension protects employees from burns
- Easy to service with "easy to remove" front panel
- Easy maintenance with bottom-mounted grease collection pan
- S/S construction on front panel & top skirt protects from wear & tear & rust
- 3/4 inch polished steel griddle surface for years of high output cooking

6061400224" Griddle with Manual Control 15.5"H x 24"W x 25"D
 6061400336" Griddle with Manual Control 15.5"H x 36"W x 25"D

APW/ WYOTT COUNTERTOP GAS CHARBROILERS

- 80,000 BTU for the 24" model, 120,000 BTU for the 36" model
- Fast start-up to prime cooking temperatures
- Adjustable grates for maximum control
- New bull-nose front extension protects employees from burns
- Easy to service with "easy to remove" front panel
- Easy maintenance with bottom-mount grease pan & removable top grates
- Self-cleaning CharRocks or Self-cleaning Radiants
- S/S construction on front panel & top skirt protects from wear & tear & rust
- Thick, cast iron "Steak Char" grates for years of high output Char Grilling.

6061400024" Natural Gas; 15.5"H x 24"W x 25"D
 6061400136" Natural Gas; 15.5"H x 36"W x 25"D



60614000



4-QT WARMER/ LADLE PACKAGES

Great for cheese, fudge, butter and more. Both lighted and unlighted packages have 4 qt inset, hinged cover, 1 oz ladle and your choice of merchandising decal. 120V, 396W, 3.3 amps.

WB4.....Unlighted
 LW4Lighted



HEATED PUMP DISPENSERS

Great for cheese, fudge, butter and more. Complete with direct-action pump, 4 qt base warmer designed to hold #10 can, spout heater, and your choice of merchandising decal or transparency. 120V, 3.3 amps.

CCWUnlighted, 4 qt
 LCCWLighted, 4 qt
 LNCPW-11.....Lighted, 11 qt.



**ROASTERCHEF™
18 QT. ROASTER OVEN**

Bake, roast, cook, steam & slow cook; Lift-out pan & rack. Oven-type temperature settings for baking or roasting w/lid rest. 1440 watts 120V/AC only
60601035527 Oven



**PANASONIC COMMERCIAL
ELECTRIC RICE COOKER**

Large capacity cooking from 5 to 23 six-ounce cups in approximately 30 minutes, with a serving capability of up to 74 three oz. portions.
60685012Panasonic Rice Cooker



**CADCO LIGHT DUTY
ELECTRIC BUFFET RANGES**

- Industrial rated burners with 5-1/2" diameter
- High speed tubular elements
- Removable elements & drip trays for easy cleaning
- Infinite heat controls
- Easy to clean chrome surface
- Adjustable leg for countertop leveling
- UL Safety & Sanitary, C-UL
- Electrical: 120 volts

6060002-Burner, 1650 watts, 13.8 amps
6060041-Burner, 1100 watts, 9 amps

5555000



60601051

60601052



IWATANI TABLETOP COOKING SYSTEMS

Offer your guests tasteful and efficient tableside presentations with these durable and attractive counter cooking systems. (See page (6?) in the Buffet & Catering chapter for more information.)

5555000Induction Stove

6060105130FW Cassette Fuel Stove

60601052ZA3 Cassette Fuel Stove

50563002CBTC-Z Chef's Torch

50563001Butane Cartridge

50563000GM5 Gas Match



WELLS ELECTRIC FRYER

- 14 lb fat capacity
 - Comes with two half-size fry baskets
 - Heavy duty, s/s swing-up element allows easy cleaning.
 - Has a manual reset safety thermostat
 - Available in 120, 208 or 240 Volts
 - 11"W x 21-7/8"D x 13-1/8H
 - Temperature range 275°-375°
- 60604004Wells Electric Fryer



WELLS SINGLE COUNTERTOP FRYER

- 15 lb fat capacity
 - Comes with heavy duty dual half-size fry baskets
 - Heavy duty, s/s swing-up element allows easy cleaning.
 - Elements have low watt density for longer oil life
 - Has a manual reset safety thermostat
 - Available in 208 or 240 Volts
 - 14-3/4"W x 23-9/16"D x 16-3/8H
 - Temperature range 275°-375°
- 60620395Wells Single Countertop Fryer



WELLS DUAL COUNTERTOP FRYER

- 15 lb fat capacity each
 - Comes with two full-size fry baskets
 - Heavy duty, s/s swing-up element allows easy cleaning.
 - Elements have low watt density for longer oil life
 - Has a manual reset safety thermostat
 - Available in 208 or 240 Volts
 - 24-13/16"W x 23-9/16"D x 16-3/8H
 - Temperature range 275°-375°
- 60620396Wells Dual Countertop Fryer

Counter Equipment

SYRUP JAR COVERS

Durable s/s covers with plastic knobs.
 55512400Hinged Syrup Jar Cover
 55512403Solid Lift Off Lid



55512400



55512402

CONDIMENT JARS

Durable white plastic jars.
 555124012-1/2 qt Crushed Fruit Jar
 555124023-1/2 qt Syrup Jar



55511703

DIPPERWELLS & FAUCET

The health dept. requires a Dipwell when ice cream is dished in bulk.
 55511703Rectangular Diprwell 10"
 55511702Dipwell Install Kit
 55512409Running Water Round Dipperwell
 55512408Dipperwell Faucet only



55512409

55512408

SERVER VEGATABLE INSET PUMPS

These pumps are ideal for use on standard vegetable insets used in steam tables.

5558320083200 Server Pump (CP6.5) fits 4 qt. inset
 5558322083220 Server Pump (CP8-1/2) fits 7 qt. inset
 5558324083240 Server Pump (CP 10-1/2) fits 11 qt. inset



SERVER FOUNTAIN JAR PUMP

This pump fits a standard deep soda fountain jar, either stainless steel or plastic. Maximum yield per stroke is 1.25 oz.

5558333083330 Pump (CP-F)



SERVER CONDIMENT PUMP & CONTAINER

This pump is ideal for pumping dressings, ketchup, and similar foods directly from the manufacturer's #10 can or our stainless steel jar #94009.

spec. order .83000 pump (CP-G)
 Can be used in place of manufacturer's #10 can for all Server products.

5559400994009 S/S Jar (CP10)





CADCO COUNTERTOP CONVECTION OVENS

- Stainless Convection Ovens are designed for use on countertop or oven stand.
- 1/4 Size Oven accommodates standard 1/4 size sheet pans and standard 2-1/2" deep half size steam table pans.
- Half Size Oven accommodates standard half size sheet pans and standard 2-1/2" deep half size steam table pans.
- Heat settings from 175° – 500°F (indirect heat).
- 120 minute timer or continuous on.
- Cool-touch safety door (double thermal glass) removeable for easy cleaning
- Four shelves included (pans not included)

6060012Cadco Half Size Convection Oven 220V
23.375"W x 22"H x 22.25"D

6060011Cadco Quarter Size Convection Oven 120V
19.25"W x 17.625"H x 19"D



RADARANGE COMMERCIAL MICROWAVE OVEN

For volume vending areas, schools, convenience stores, or cafeterias. 1-touch operation with 5 power levels and 10 programmable timing pads or time-entry option. 1.2 cubic foot interior. 1,000 watts. 15 amp, 120 V, 60 Hz Limited 3 year warranty. Exterior dimensions: 14 1/4"H x 21 3/4" W x 19 3/4" D.

606211000 W RCS10MP



RADARANGE COMMERCIAL MICROWAVE OVEN

Medium to high volume foodservice locations. S/S inside and out. Compact, durable, stackable. 11 power levels, stores up to 100 menu items. 1.2 cubic foot interior. 1,200 watts. 20 amp, 120 V, 60 Hz Full 3 year warranty.

Exterior dimensions: 14 3/4"H x 21 5/8" W x 19 13/16" D
606251200 W RFS12MPS



HEAVY DUTY COMMERCIAL MICROWAVE OVEN

Industry best for even heating. Heats large, bulk quantities or individual servings fast! S/S inside and out for easy cleaning and years of dependable use. 11 power levels; stores up to 100 program menu settings. Auto voltage sensor, multi level feed system. 208/240 V, 60 Hz. Full 3 year warranty.

60629 2100 W HDC21



HEAVY DUTY COMMERCIAL MICROWAVE OVENS

Heats large, bulk quantities or individual servings fast! S/S inside and out for easy cleaning and years of dependable use. 11 power levels; stores up to 100 program menu settings. Auto voltage sensor,. 1,700 watts. or 2200 watts. 1.0 cu. Ft capacity. 20 amp, 208/240 V, 60 Hz. Full 3 year warranty. Exterior 19 "W x 18 1/4" H x 26 1/4" D.

60628 1700 W RC17S

60630 2200 W RC22S

PANASONIC MICROWAVES



1,000 WATT

- Ideal for restaurants, convenience stores vending, and office coffee use
 - 1000 Watts of power for quick cooking
 - “Grab & Go” door handle
 - Unique bottom energy feed
 - 5 minute dial timer
 - Compact size
- 60685004



1,000 WATT

- Ideal for restaurants, convenience stores vending, and office coffee use
 - 1000 Watts of power for quick cooking
 - “Grab & Go” door handle
 - Unique bottom energy feed
 - Braille keypad
 - Compact size
- NE-1054



1,000 WATT PRO I

- Ideal for restaurants, institutions, convenience stores and vending.
 - 1000 Watts of power for quick cooking
 - 3 power levels
 - Unique bottom energy feed
 - Braille keypad
- 60685007



PANASONIC 1,200 WATT PRO I

- Ideal for full and quick service restaurants, supermarkets, delis, convenience stores and vending
 - Compact size, heavy-duty performance
 - Stainless steel construction
 - Top and bottom energy feed
 - “Grab & Go” door handle
 - 10 programmable memory pads
 - Enhanced diagnostics
- 60685000



PANASONIC 1,700 WATT

- Ideal for full and quick service restaurants, supermarkets, delis, convenience stores
 - Compact size, heavy-duty performance
 - Stainless steel construction
 - Top and bottom energy feed
 - “Grab & Go” door handle
 - 10 programmable memory pads
 - Enhanced diagnostics
- 60685002



PANASONIC 2,100 WATT

- Ideal for full and quick service restaurants, supermarkets, delis, convenience stores and vending
 - Compact size, heavy-duty performance
 - Stainless steel construction
 - Top and bottom energy feed
 - “Grab & Go” door handle
 - Programmable memory pads
 - Enhanced diagnostics
- NE-2157



PANASONIC SONIC STEAMER

- Sonic steamer powered by microwave technology
 - Ideal for heavy volume steaming and microwave applications in restaurants, supermarkets, delicatessens, school food service, health care and banquet catering
 - Holds two full-size 4" tall steam table pans with covers
 - Top and bottom energy feed with 4 magnetrons (Heating elements)
 - “Grab & Go” door handle
- NE-2180 . . . 2100 Watt Sonic Steamer
NE-3280 . . . 3200 Watt Sonic Steamer

Panasonic



PANASONIC COMBI WAVE™ OVEN

- Commercial Convection/Microwave Oven
 - Ideal for full and quick service restaurants, supermarkets, delis, convenience stores and vending
 - 3900 total Watts of power for quick cooking
 - Stainless steel construction
 - Top and bottom energy feed
 - “Grab & Go” door handle
 - Compact size
- NE-C1153 . . . Panasonic Combi Wave™ Oven



WARING BAR BLENDERS

2-speed motors and simplicity of operation put more specialty drinks and classic cocktails into production. Rugged, one-piece stainless steel cutting blade.

Exclusive metal-reinforced rubber drive coupling is easily replaced. Die-cast zinc base is epoxy powder coated. Available with either 32 oz. stainless steel container, or clear 48 oz. unbreakable polycarbonate container with lid.

120VAC, 50/60 Hz

60601089 . . . BB150 w/Clear Container

60601090 . . . BB150S w/SS Container



60601090



60601089



60601086



60601085

WARING HALF GALLON BLENDERS

Heavy-duty, two-speed, 1 HP commercial motor. Sturdy die-cast base with 64 oz. stainless steel or 48 oz. clear, unbreakable polycarbonate containers. Easy to replace drive coupling on-site. 120 VAC, 50/60 Hz

60601085 . . . HGB140 w/Clear Container

60601086 . . . HGB150 w/S/S Container



WARING HIGH-VOLUME BLENDER

1-Gallon Blender easily handles everything from soups and bisques to sauces, mixes, dips, dressings and vegetable purée - and all those special puréed meals in healthcare. Quiet 3 HP motor; futuristic base design is ergonomic, easy to clean and support; easy-touch controls With 3 speeds and pulse; 2 handle stainless steel container with clear see-through lid; sure-grip feet assure stable operation.

60601088 . . . CB10 Blender

WARING SELF-TIMER 2-SPEED BLENDER

Increase efficiency with this self-timing blender, with self timer, 3 seconds, 15 seconds or manual settings.

60601094 . . . 7015N Blender



WARING MARGARITA MADNESS® BAR BLENDER

Blend a batch of Margaritas & Daiquiris in 5 seconds! High power and high speed. Easily replaceable metal-reinforced drive couplings. Heavy-duty 1 hp 2-speed motor. Heavy-duty, 1-piece s/s cutting blade. 48 oz. clear, unbreakable polycarbonate container. 120VAC, 50/60 Hz.

60601091 . . . MMB142 Blender



VITA-MIX® TOUCH N GO BLENDING STATION

This on-counter Touch And Go offers 6 different programs allowing you to blend any drink consistently at the touch of a button. Quiet, 2+ hp motor, 37,000 bare motor speed, and 48 oz/1.5L polycarbonate container w/ removeable cover hinge design. NSF listed.

35100 Touch N Go Blender



VITA-MIX® 2-STEP DRINK MACHINE

Blend the perfect granita, frozen coffee and tea, smoothie or margarita with the same machine. 2+ hp , 37,000 rpm, s/s enclosed blade assembly with sealed ball bearings. Clear polycarbonate container is virtually unbreakable. Blends as little as 4 oz. with the same consistency & quality as a full load. Put ingredients in the blender, set the timer and walk away. It stops automatically!

6061230 1230 Blender



THE VITA-MIX® MIX'N MACHINE™

The industry's leading frozen dessert mixer, can incorporate candies, cookies and other hard-to-mix ingredients into hard or soft serve ice cream or yogurt to make highly profitable frozen treats. Motor speed is 3,440 RPM bare motor speed; 120 VAC, 50/60 Hz., 2.7 amps

570 570 Mix-N Machine

Counter Equipment



HAMILTON BEACH HALF GALLON BAR MIXER

High-power/low-energy consumption machine for professional demands. 2-speed with pulse option creates precise blending. Four s/s blades ensure perfectly smooth drinks with no unwanted ice or fruit

chunks. Break and stain resistant polycarbonate container with easy-to-read graduated measurement marks. 1/2 hp, 120 Volts, 60 Hz.

91200 Bar Mixer



HAMILTON BEACH BAR BLENDER

Perfect for smoothies, margaritas, daiquiris, iced cappuccinos, granitas, and more. The worldwide standard for dependable performance. Separate "on/off" and 2-speed toggle switches located for quick access. Four s/s blades ensure perfectly smooth drinks with no unwanted ice or fruit chunks. Break-resistant 44 oz. polycarbonate container, or a 32 oz. s/s container. 1/4 Hp., 120V, 60 Hz. 60601048 . . . 908 Clear Container 60601049 . . . 909 S/S Container



TEMPEST BLENDER

High torque, efficient, quiet; 3 programmable cycles give you sets of pulses & speeds for precision blending. Rotary timer. S/S blades ensure smooth drinks without unwanted ice or fruit chunks. Electronic speed control with load sensor provides constant speed regardless of the load. With a 32 oz. Lexan® container, vinyl lid with filler-cap. 2+ hp 91555 Tempest Blender



COMMERCIAL BLENDER

Perfect for salsas, dips, soups, sauces, cocktails, smoothies, margaritas, and more. Hi power/lo energy consumption for professional demands. 2-speed w/pulse option for precision blending. 44 oz. polycarbonate container with graduated measurement marks and superior vortex blending action. 3/8 hp 60600918 . . . 918 Blender



HAMILTON BEACH MIX 'N CHILL DRINK MIXER

Perfect for shakes, smoothies, yogurts, frozen custards, hard ice cream, candy mix-ins, and more. Rotary dial with variable speed selections for perfect

results. The s/s agitator is designed for vertical blending action to mix candies, cookies, fruits, and flavoring. 3/4 hp. 60694950 94950 Mix N Chill



HAMILTON BEACH DRINK MIXER

Perfect for shakes, smoothies, cocktails, eggs, batters, ice cream drinks, and more. 3- speed toggle switch is located for quick and easy access. Designed for durability, the s/s agitator crushes ice and cuts through hard ice cream.

Automatically activates when the cup is placed in position, and stops when cup is removed. 1/6 hp. 120V, 60 Hz. 555936 936 Drink Mixer



TRIPLE HEAD DRINK MIXER

Perfect for milk shakes, smoothies, bar cocktails, eggs, batters, ice cream drinks, and more.

The 3-speed toggle switch is conveniently located for quick and easy access. 55500950 . . . 950 Malt Mixer



VITA-PREP® COMMERCIAL FOOD PREP

The professional chef's power tool - producing silky smooth purees, grinding whole spices & grains, chopping vegetables and more. Variable speed, 2+ peak horsepower, with 37,000 rpm bare motor speed. 64 oz./2L container. 6065002 Vita-Prep Blender



VITA-MIX® 2-SPEED DRINK MACHINE

This basic 2-speed blender is the most cost-effective blender you can buy - up to three times faster and five times more powerful than other comparable "commercial" blenders. 2+ peak hp motor 37,000 RPM bare motor speed; 120 VAC, 50/60 Hz., 11.5 amps. 64 oz./2L polycarbonate container. 606748 748 Drink machine



VULCAN GAS RESTAURANT RANGES

- S/S front, front top ledge, back riser, high shelf, legs; sides finished in heat-resistant paint.
- Ten 26,000 BTU/hr. cast top burners with lift-off, burner heads. Individual pilots for each burner.
- 12 x 24" aeration plates and removable 12 x 12" top grates finished with matte black porcelain.
- Full width pull-out crumb trays under burners.
- Two 35,000 BTU/hr standard ovens measure 26-1/4"W x 22"D x 14-1/2"H. Thermostats adjust from 150° to 500°F. One oven rack and two rack positions per oven.
- 3/4" rear gas connection.
- One year limited parts & labor warranty.



- 60603614.....Vulcan Mod90.....24", 4 Burners, 1 Ovens
- 60603616.....Vulcan Mod90.....36", 6 Burners, 1 Ovens
- 60603619.....Vulcan Mod90.....60", 10 Burners, 2 Ovens



GH6 with Back



GHCB 34S

VULCAN GH SERIES—HEAVY-DUTY GAS RANGES

- S/S front, front top ledge and 6" adjustable legs, painted sides
- Eight different top arrangements to meet the demands of any full cooking operation. Choose any combination of open burners, griddle tops or even-heat hot tops. Radial fin hot top also available.
- Choice of standard oven base, Snorkel™ convection oven base, cabinet base or modular cooktop units
- 1-1/4" front gas manifold or rear gas connection available
- Exterior Dimensions D39-1/8" x H36" on 6" legs

STANDARD OVEN

- Controls located in the cool zone
- One oven rack with two rack positions
- 50,000 BTU/hr. flame retention cast iron burner with pilot ignition
- Thermostat adjusts from 150° to 500°F
- Oven dimensions W24" x D28" x H14"

CONVECTION OVEN

- Controls located in the cool zone
- Three oven racks with five rack positions
- 32,000 BTU/hr. burner
- Thermostat adjusts from 200° to 500°F
- 1/4 HP blower motor with 7' cord and plug

Vulcan GH30W34", Super radial fin hot top

Vulcan GH45W34", 4 open burners

Vulcan GHX45W17", 6 open burners

Vulcan GH3/7W34", 3 open burners, even heat top

Vulcan GH6W34", 6 open burners

Vulcan GH60W34", Griddle top

Vulcan GH60/45.W34", 2 open burners, griddle top

Vulcan GH72/45.W34", 2 open burners, even heat top

Vulcan GH72W34", 2 even heat top sections

Cooking Equipment



60651016

WOLF CHALLENGER RESTAURANT RANGES

Few other ranges offer the cooktop versatility you'll find with Challenger - a complete selection of options suited to the way you cook. Top arrangements can combine 26,000 btu open burners with hot tops; griddle plates with 1/2", 3/4" or 1" thickness; combination raised griddle broilers; step-up rear burners; or a durable stainless steel work surface. The Challenger also has the widest oven in the business - our 29" chef-size oven that is an industry benchmark for consistently delicious results.

60651006CH229FT34

34" Wolf Single Oven Range with 2 burners and a 29" fry top

60651009CH41829FT34

34" Wolf Single Oven Range with 4 burners and a 22" fry top

60651012CH429FT22

34" Wolf Single Oven Range with 4 burners and a 22" fry top

60651015CH6229FT34

68" Wolf Double Oven Range with 6 burners and a 34" fry top

60651016CHR-6-29

34" Wolf Single Oven Range with 6 burners



CHR-6229



CHSSR-418

WOLF COMMANDER HEAVY DUTY RANGES

Commander heavy-duty sectional ranges deliver unmatched durability and reliable performance, year after year. Whether you need a single range or a complete battery of cooking equipment, Commander will give you the versatility and performance you need.

Create a custom rangetop:

6 Burner 36" Range

36" Hot Top

French Graduated Hot Top

Open Burner - Half Hot Top Combination

36" Thermostatically Controlled 1" thick Griddle Top

Step-Up Rear Burners

Stainless Steel Work Surface



Commander Range
with Hot Top and
Salamander Broiler



SOUTHBEND RESTAURANT RANGES



336D

- 6 clog-free, 27,000 BTU burners
- S/S front & shelf
- Removable cast iron, flush-top grates
- Single-piece drip tray under burners
- Heat resistant door handles
- Hinged lower valve panel
- One year Parts & Labor Warranty

Standard Oven

- 32,000 BTU
- Large 26"W x 26-1/2"D oven - full sheet pans fit both ways
- Single rack per oven
- Equipped with flame safety device
- Thermostat range from 250° to 500°F with low setting



336D-F



360DD-2G-F

360DD-2G-F

- Commercial gas double oven range, with 6 burners & 24" griddle
- 6 clog-free, 27,000 BTU burners
- Smooth polished 1/2" thick hot-rolled, ground steel-plate griddle w/raised sides
- S/S front & shelf
- Removable cast iron, flush-top grates
- Single-piece drip tray under burners
- Heat resistant door handles
- Hinged lower valve panel
- One year Parts & Labor Warranty

Standard Oven

- 32,000 BTU
- Large 26"W x 26-1/2"D oven - full sheet pans fit both ways
- Single rack per oven
- Equipped with flame safety device
- Thermostat range from 250° to 500°F with low setting



ES-10SC



GS-25SC

SOUTHBEND MARATHONER GOLD SERIES CONVECTION OVENS

The Marathoner Gold Convection Oven is available in several sizes to accommodate various kitchen needs. Ovens are available in standard or bakery depth, single or double deck, with standard, cook and hold, or programmable controls. The gas series features a stainless steel exterior and 90,000 BTU burners for quick temperature recovery. The electric series features 12 kw high-efficiency heating units.

Standard Depth ovens accommodate one full size (18" x 26") sheet pan per oven rack left to right in the oven. Bakery Depth ovens accommodate full size sheet pans OR two half size (18" x 13") sheet pans per oven rack.



U. S. RANGE PERFORMER MEDIUM DUTY GAS RESTAURANT RANGES

24", 36", 48", 60" and 72" models available!

- 26,000 BTU universal open burners
- Raw cast-iron top grates
- Contoured designer control knobs
- 3-position removable rack guides
- Embossed oven side liners
- 1-piece ribbed oven bottom w/perimeter lip
- Optional griddles standard left side
- Optional hot-tops standard right side
- Optional raised griddle/broiler standard right side
- Standard with high shelf



U.S. RANGE SUMMIT SERIES GAS & ELECTRIC CONVECTION OVEN

- S/S front, 36" wide
- Black powder epoxy coat sides top & legs
- Fully porcelainized oven interior w/coved corners
- Solid state controls w/1 hour timer
- Auto cool-down & auto setback features
- Patented Safe Door feature
- 2-speed 1/2 hp fan motor
- Electronic ignition
- 60/40 doors w/lights & window sin each door
- Temp. range: 150°F to 550°F

Gas Convection Ovens

- SGM-100Full Size Single Deck, 60,000 BTU, 39" deep
- SGM-200Full Size Double Deck, 120,000 BTU, 39" deep
- SGM-1000Full Size Single Deck, 60,000 BTU, 43" deep
- SGM-2000Full Size Double Deck, 120,000 BTU, 43" deep

Electric Convection Ovens

- SEM-100Full Size Single Deck, 11 kw, 39" deep
- SEM-200Full Size Double Deck, 22 kw, 39" deep
- SEM-1000Full Size Single Deck, 11 kw, 43" deep
- SEM-2000Full Size Double Deck, 22 kw, 43" deep

U.S. RANGE SUNFIRE GAS CONVECTION OVEN

- S/S front, 40" wide
- Black powder epoxy coat sides top & legs
- Fully porcelainized oven interior w/coved corners
- Solid state controls w/1 hour timer
- 2-speed 1/2 hp fan motor
- Electronic ignition
- 60/40 doors w/lights & windows in each door
- Temp. range: 200°F to 500°F

SDG1Full Size Single Deck, 80,000 BTU, 43" deep

SDG2Full Size Double Deck, 160,000 BTU, 43" deep



REGAL SERIES CHAR-GLO BROILERS

Gas-powered char broilers with adjustable grates, ceramic coals or cast iron radiants, built-i front grease trough, removable drip pan and grease container, individual burner controls, Choose 18,000 BTU aluminized steel burners, or 45,000 BTU cast-iron burners. Widths: 24", 30" 36", 48" and 60" RG/C-HDSA-36



**Blodgett MARK V XCEL
ELECTRIC CONVECTION OVEN**

Angle iron frame, S/S front, top and sides, solid state manual control, dual-pane thermal glass window, anti-microbial coated porcelain door handle with simultaneous door operation, triple mounted pressure door lock door design with turn buckle assembly, double sided porcelain baking compartment with coved corners, side-mount interior lights, 2-speed blower motor, modular slide-out control panel, 5 chrome plated racks, 11 rack positions, 11 kW per section, 2 year warranty. (Shown with optional casters & digital control.)

Single:One base section w/25" S/S legs

Double:Two base section w/6" S/S legs & vent connector

Add'l Section:Two base section w/6" S/S legs & vent connector

Base Section:One base section (oven only)



Mark V Xcel



DFG-50

**Blodgett DFG-50 HALF SIZE
GAS CONVECTION OVEN**

- Full angle-iron frame
- Stainless steel front, back top, sides and legs
- Dual pane thermal glass window
- Four-inch stainless steel legs for single unit; 7-inch stainless steel stand for double unit
- Single chrome-plated door handle
- Double-sided porcelain baking compartment, 5 chrome-plated racks, 9 rack positions with a minimum of 1-5/8 (41mm) spacing
- 27,500 BTU/hr per single unit; 55,000 BTU/hr. per double unit
- Electronic spark ignition control system
- Removable dual tube burner
- Flue vent for each section

BLODGETT GAS PIZZA DECK OVEN

Now standard with Ultra-Rockite deck and 50,000 BTUs per section. S/S front, top, sides and back with rigid angle iron frame. Baking compartment is 42" w x 32" deep x 7" h. Counterbalanced doors with heavy chrome-plated tubular steel handles. Aluminized steel combustion chamber & baking compartment. 2-year warranty.



961P

**BLODGETT SMART GENERATION
CONVEYOR OVEN**

A breakthrough in conveyor oven technology, delivering more consistent results and increased capacity. These ovens cook faster at lower temperature, and use less energy for greater efficiency. An enhanced airflow design features convection fans that circulate air in opposite directions, forcing heat to surround and penetrate food evenly across the full width of the conveyor belt.



MT1828G

VULCAN FULL-SIZE

GAS & ELECTRIC CONVECTION OVENS

- Full-size and extra-deep models
- S/S front, sides and top; painted legs
- Stainless steel doors with windows
- 44,000 BTU/hr. burner (per section) or 12.5 total kw (per section)
- Electronic spark ignition eliminates need for standing pilot light on gas models
- 1/2 hp 2--speed oven blower motor
- Choice of solid-state temperature control or electronic control
- Oven cool switch for rapid cool-down
- Porcelain enamel on steel oven interior
- Five nickel-plated oven racks (per section) with eleven rack positions
- 3/4" rear gas connection with regulator and manual shut-off valve (gas models)
- One-year limited parts and labor warranty

OPTIONS

- S/S legs (option on single-deck models)
- "Roast & Hold" control (D gas models)
- S/S open stand with storage rack (single-deck models)
- Casters
- 34" s/s stand with legs or casters and nine-position rack storage capacity
- "Flanged feet" (electric models)
- Stainless steel rear motor enclosure

VCG SERIES — FULL-SIZE GAS CONVECTION OVENS

60603622Single Section; 44,000 BTU, 36-1/2" wide

VC6GSingle Section; 44,000 BTU, 45-1/2" wide

60603624Double Section; 88,000 BTU, 36-1/2" wide

VC66GDouble Section; 88,000 BTU, 45-1/2" wide

VCE SERIES — FULL-SIZE ELECTRIC CONVECTION OVENS

VC4ESingle Section, 41-1/2"wide, 12.5 amp, 208/240V, 60 Hz, 1 or 3 phase

VC6ESingle Section, 45-1/2"wide, 12.5 amp, 208/240V, 60 Hz, 1 or 3 phase

VC44EDouble Section, 41-1/2"wide, 25 amp, 208/240V, 60 Hz, 1 or 3 phase

VC66EDouble Section, 45-1/2"wide, 25 amp 208/240V, 60 Hz, 1 or 3 phase



CADCO HALF & QUARTER SIZE ELECTRIC CONVECTION OVENS

High performance convection ovens designed for use on a countertop or an oven stand. Will handle up to 3 sheet pans with no rotation necessary. High-speed fan for even air distribution. 120v, 1500w, 12.5 amp. 1/4 Size Ovens accommodate standard 1/4 size sheet pans and standard 2-1/2" deep half size steam table pans. Half Size Ovens accommodate standard half size sheet pans and standard 2-1/2" deep half size steam table pans.

6060011Quarter Size

6060012Half Size



DUKE FULL SIZE CONVECTION OVENS

Duke Convection Ovens have better cooking performance than the competition with less energy input (40,000 BTU vs. 50,000 or 60,000 for other gas ovens). With four (4) inches more cavity height with the same exterior height as the competition you get more room for

your money. Coved corners are in the cavities, with no seams on the bottom, making cleaning a snap.

E101-GSingle Section, Gas

E102GDouble Section, Gas



**FRYMASTER
ECONOMY
GAS FRYERS**

Versatile fryers with sensitive, fast action thermostats for quick sensing of cold food in the fry pot. Open pot design is totally cleanable for longer oil life and great tasting food. Large heat transfer area for more product per load. GF 14 is 30-40# capacity, 4200 ft elev., 100,000 BTU, 65# fries per hour, GF40 is 40-50# capacity, 122,000 BTU, produces 80# fries per hour. Casters optional.
60615002GF14SP Stainless Steel pot

Frymaster MJ35



**FRYMASTER
ALL PURPOSE
GAS FRYER**

Versatile, high-performance, low-maintenance. With an open frypot design with no tubes for easy cleaning and a large heat transfer area for more product per load. S/S frypot, and center-line thermostatic controls for precision control and rapid response. 10,000 BTU, 65# fries per hour. Casters optional.
60615004MJ35SD S/S Pot

**FRYMASTER
HIGH VOLUME
GAS FRYER**

Specifically designed for high volume production. Easy-to-clean open pot design, with no tubes. Deep cold zone with 1-1/4" IPS ball-type drain valve. Multiple orifice burner with no tube radiants to burn out, no cleaning or adjusting air shutters, no electric connection required. Casters optional.
60615006GF40SD S/S Pot and Door



**FRYMASTER
GAS FRYER**

Specifically designed for chicken, fish and breaded products. Easy-to-clean open pot design, with no tubes. Deep cold zone with 1-1/4" IPS ball-type drain valve. Centerline thermostat, 7 - 10 sec. response to loads, 1° anticipating action, reduced temp. overshoot. Stainless steel frypot. Multiple orifice burner with no tube radiants to burn out, no cleaning or adjusting air shutters. Casters optional.
MJCFS/S Pot



FILTER MAGIC® SYSTEMS

The fast, safe, simple-to-use systems for a more consistent, higher quality product, and longer lasting shortener life. The industry's first hands-off filtering system sets the standard for cost savings, safety, ease-of-operation, and dependability. This built-in system features washdown and instant-change filter - with no hot hoses to handle. Filters in just 3 to 5 minutes and one fryer can be filtering while the others are frying.
FM245B



SPAGHETTI MAGIC® SYSTEMS

Frymaster's new state-of-the-art Pasta Cooker delivers incredibly large amounts of quality cooked pasta automatically, reliably, and inexpensively. It incorporates all the labor-saving features you need, such as: solid state programmable controls, easy-to-clean NSF approved cookpot, optional auto fill and auto skim features. It will deliver up to 1,080, 10-oz. servings per hour (8SMS), or 1,440, 10-oz servings per hour (GSMS).
8SMSElect.
GSMSGas



Pitco SG145S with optional casters



SG14S

PITCO SOLSTICE™ SERIES DEEP FAT FRYERS

Solstice series fryers will allow you to cook more product, more efficiently and provide an improved operating environment with cooler flue temperatures. Major improvements in the filtering process eliminates steps, so fryers are easier to clean and return to service faster. Each model in the Solstice series is the same depth front to back, making it easy to order and build a standard battery of fryers to meet your unique needs. 110,000 BTU
SG14S S/S Tank

PITCO ECONOMY TUBE FIRED GAS FRYERS

Pitco quality at value price, the model 35C+ is a free-standing, stand-alone fryer with welded tank. Smooth machine peened finish ensures easy cleaning. Long lasting, high temperature alloy stainless steel heat baffles are mounted in the heat exchanger tubes to provide maximum heating and combustion efficiency. Standing pilot light design provides a ready flame when heat is required. Cabinet is constructed of stainless steel front and door with galvanized sides and back. 90,000 BTU
60602001Pitco 35C+S, S/S Pot spec. order ...Pitco 35C, Steel Pot



35C



PITCO 40S ECONOMY FRYER

Natural gas floor model, with 40lb fat capacity and 14 x 14" frying area. 105,000 BTU, stainless steel tank & door.
40S

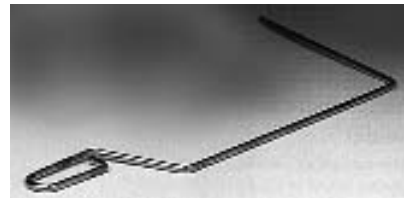

FRYER CLEAN-OUT ROD

An aluminum rod, properly angled with a blunt end to break up masses of debris in the cool zone and drain prior to filtering or draining.
60612345

PITCO MOBILE FILTRATION SYSTEM

Filter pan and pump assembly enclosure made of polished s/s, all other surfaces are nickel plated finish. Welded steel frame on four ball-bearing swivel casters for easy movement. 1/3 hp motor and pump assembly, complete with 5' flexible, sanitary, hi-temp return hose & nozzle. Large filter area for large fryer filtering.
RP18Standard Pump
RP18Reversible Pump

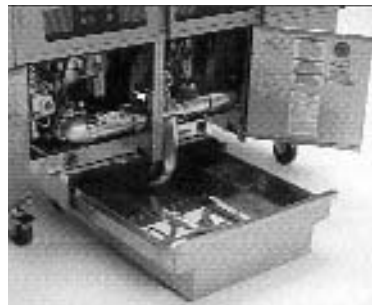

PITCO UNDER FRYER FILTRATION SYSTEM

Filter pan and pump assembly enclosure made of polished s/s, all other surfaces are nickel plated finish. Welded steel frame on four ball-bearing swivel casters for easy movement. 1/3 hp motor and pump assembly, complete with 5' flexible, sanitary, hi-temp return hose & nozzle. Large filter area for large fryer filtering.
SF50A
SF65A



VULCAN ECONO FRYER GAS FLOOR MODEL FRYERS

- Stainless steel front and sides, 6" adjustable legs
- Stainless steel fry tank
- Milivolt control system
- Combination gas shut-off valve, regulator and pilot ignition
- 1" full port, ball-type drain valve
- One-year parts and labor warranty

OPTIONS

- 6-1/4" adjustable stainless steel legs
- Set of 4 casters (2 locking)

60603610.....EF3, Natural Gas

60603612.....EF3, Propane

Model	Width	Depth	Height	Tank	BTU/hr.	Fry Capacity	1/4" Frozen Fries/Hr.
EF3	15-1/2"	29-3/4"	47-1/8"	14" x 14"	90,000	35-40 lbs.	65 lbs.

VULCAN GR SERIES—GAS FLOOR MODEL FRYERS

- Stainless steel front, front top, sides and 6" adjustable legs
- Stainless steel fry tank with twin baskets
- 1" full port, ball-type drain valve (1-1/4" on GR85)
- 1/2" rear gas connection (single fryers) or 1-1/4" rear gas connection (multi-fryer batteries)
- Combination gas shut-off valve, regulator and pilot ignition
- Choice of three control systems includes:
 - GR—milivolt control
 - GRD—solid-state control with user selectable fat melt modes
 - GRC—programmable computer control with user selectable fat melt modes, automatic and manual boil out modes, 10 programmable product keys

OPTIONS

- KleenScreen Filtration System for 2-6 unit batteries
- Mobile filter systems for individual fryers
- Automatic basket lifts (GRD & GRC models)
- Electronic ignition (GRD & GRC models)
- Casters (set of 4)
- Second-year extended limited parts and labor warranty



Vulcan GRD35

Model	Width	Depth	Height	Tank	BTU/hr.	Fry Capacity	1/4" Frozen Fries/Hr.
GR35	15-1/2"	29-3/4"	47-5/8"	14" x 14"	90,000	35-40 lbs.	65 lbs.
GR45	15-1/2"	29-3/4"	47-5/8"	14" x 14"	120,000	45-50 lbs.	100 lbs.
GR65	21"	29-3/4"	47-5/8"	19-1/2" x 14"	150,000	65-70 lbs.	115 lbs.
GR85	21"	34-3/4"	47-5/8"	36-1/4"	150,000	70-85 lbs.	125 lbs.

SR42G GAS ECONOMY FRYER

Basic frying at its best, designed for all-purpose usage! Combines efficiency with more capacity - great for chicken, breaded onions, and other menu selections in mid to high volumes. Quick heat-up relative to gas consumption and low idle costs during slow periods.

- 35 - 43 lb fat capacity
- 105,000 BTU
- S/S frypot, front & doors
- Cook depth: 4-1/8"

SR42G



Cooking Equipment

WOLF HEAVY-DUTY HOT PLATES

Designed for versatility and durability that fit any kitchen need. Available in eight models in 12", 24", 36" and 48" widths. Standard 30,000 BTU/hr lift-off burners, or choose 2" or 4" step-up rear burners or 11,000 BTU/hr half hot top on rear burner.

60651021Wolf 2-burner, 12" Hotplate

60651022Wolf 4-burner, 24" Hotplate



60651021



60651022



WOLF REGENCY SERIES GRIDDLES

Take a look at the variety of Regency Series griddles available for your kitchen—there's one designed for your cooking needs. Five models from 24" to 72" wide are available in counter designs. RMG models are manually-controlled with 30,000 BTU/hr burners every 12" of width; RTG models are thermostatically-controlled with 27,500 BTU/hr burners; RSAE models have the ultimate in thermostatic controls with 25,000 BTU/hr burners, and electronic ignition.

60651017Wolf 36" Regency Griddle

60651020Wolf 24" Regency Griddle

60651018Wolf 48" Regency Griddle



60651020



60651017

WOLF FLOOR MODEL SUPER CHARBROILERS

Innovative design features finned cast alloy radiants that produce infrared rays to seal in the juices. Steaks, chops, hamburgers and seafood have a delicious, charcoal-broiled flavor! Other features include: Flame-Arrestor grates with cast-in pitched grease trough on each blade; automatic burner lighting; individually controlled direct action burners; reflector baffle under each burner which creates a "cool zone" in the grease drawer. Models with standard ovens are 33-7/8" deep and 25" wide with 20,000 BTU/hr oven, and 36" and 47" widths with 30,000 BTU/hr oven.

60651023Wolf 25" Broiler w/Oven

60651025Wolf 36" Broiler w/Oven



60651025

WOLF COUNTER MODEL CHARBROILERS

These great performing gas charbroilers have cast-iron radiants, 5-1/4" wide reversible grates, pilot ignition, grease drawer, s/s back panels, top trim, stub back and grease trough, with s/s sides and 4" adjustable legs.

60651023.....25-1/4", SCB-25-C58,000 BTU

60651025.....36", SCB-36-C87,000 BTU

60651027.....46-3/4", SCB-47-C116,000 BTU

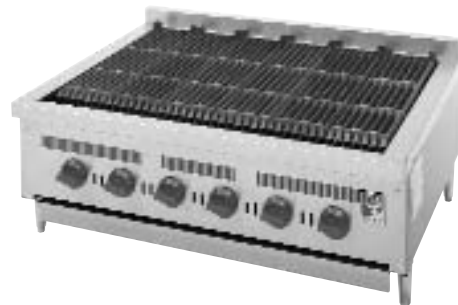



GROEN VORTEX™ CONVECTIONLESS STEAMER

Vortex™ combines the benefits of a convectionless steamer with the power of convection cooking. This results in ease of cooking, even temperatures, and superior food quality. Convection cooking in a convectionless steamer. 3 and 6-pan units can be stacked to create 6 or 12-pan units. No boiler, water treatment filters, daily blow downs, or deliming required. Reduces preventative maintenance. Easy to clean and maintain. Substantial savings in labor and supplies. No drain or water hook-up required. Self-contained unit holds 4 gallons of ordinary tap water for lower installation costs and flexibility of placement in the kitchen. Dry heating element. The heating element is not immersed in water for minimal maintenance and to eliminate the need to delime the heating element. Standard "hold feature" holds food for hours allowing control of food quality. 90 minute timer with buzzer.
 60606000HY-3E Vortex 3-Pan Steamer

GROEN PREFILTER SYSTEM & PREFILTER REPLACEMENT CARTRIDGES

The PureSteem™ Prefilter System is designed to address sediment build-up problems caused by high particulate water supplies. Can be easily connected to existing PureSteem™ Water Treatment System installations, prolonging the life of the filters. Includes a mounting bracket and a 5-micron filter encased in a clear housing container.
 55539025.....Prefilter System w/2 Cartridges
 55539026.....Replacement Filter Kit, A & B Cartridges



GROEN STEAM JACKETED KETTLES

We carry Kettles for all your needs, in gas & electric; Stationary and Tilting; Tabletop and Floor Mount; from 10 quart capacity to 100 gallons. Call us for more information.



GROEN TILTED BRAISING PANS

We carry Braising Pans for all your needs, in gas & electric; Tabletop and Open leg Floor Mounted; in sizes from 10 gallons to 40 gallons. Call us for more information.



SMARTSTEAM™ BOILERLESS STEAMERS

The gas-powered SmartSteam boilerless steamer produces 62,000 BTUs per cavity. Our electric model generates 14.4 KW of cooking power per cavity. The result is the fastest preheat and cook times in the business. Forget about recovery issues. Get rid of the boiler, get rid of the water hassles. SmartSteam boilerless steamers can use even poor-quality tap water, which means no costly water treatment filters. They also never need deliming. Just wipe them down and you're done. And the interior mirror finish makes it that much easier.

- SSB3E3-Pan Electric Tabletop
- SSB5EF5-Pan Electric Stand Mount
- SSB10EF10-Pan Electric Double Stack Stand Mount

CLEVELAND RANGE STEAM EQUIPMENT



STEAM JACKETED KETTLES

Electric: 3, 6, & 12 gal. single or twin hand-tilt models

Direct Steam: 3, 5, 6, & 12 gal. hand tilt models

Floor Mounted Electric: 20, 25, 40, 60 & 80 gal. stationary & tilting

Floor Mounted Gas: 40, 60 & 80gal. stationary & tilting

Floor Mounted Direct Steam: 25 - 250 gal. stationary & 25 - 100 gal tilting models

Electric Mixer Kettles: 12 - 80 gal single & twin manual or power tilting models

Direct Steam Mixer Kettles: 12 - 150 gal single & twin manual or power tilting models

TILTING SKILLETS

Countertop Electric: 10 & 15 gal. balanced hand-tilt models

Floor Mount Electric: 30 & 40 gal. tilting nodular or open leg models

Floor Mount Gas: 30 & 40 gal. tilting nodular or open leg models

STEAMCRAFT PRESSURE & PRESSURELESS STEAMERS

Pressureless: Gas, electric & direct steam, 3, 5, & 10 pan capacity

Pressure/Pressureless Convection: Gas, electric, direct steam, & steam coil, 16 & 24 pan capacity

Pressure: Gas, electric, direct steam, & steam coil, 16 & 24 pan capacity

VULCAN STEAM JACKETED KETTLES



KETTLES MODULES

- 18, 24 & 36" wide bases
- Gas, electric & direct steam
- 2/3 jacketed kettles available in 6 & 10 Gal. models
- S/S interior & exterior
- Single pantry faucet
- Drain in cabinet
- Automatic boiler blowdown on gas & electric models

2/3 JACKETED TILTING KETTLES

- 316 Stainless steel liner
- Faucet bracket
- Clean lock
- Splash proof housing
- 50 psi

FULLY JACKETED STATIONARY KETTLES

- All stainless steel construction
- Stainless steel spring assist cover
- 2" plug draw off valve
- Graduated measuring rod
- Stainless steel strainer
- Flanged feet
- Faucet bracket
- Gas models: Electronic ignition



MARKET FORGE STEAMIT

This compact model is versatile, easy-to-use and install-giving you quick, energy-efficient, healthful steam pressure cooking at the touch of a button. Saving you space, time, and even fuel, it's also easy to clean and maintain.



**MARKET FORGE STEAMTECH
COUNTERTOP STEAMER**

Think you can't afford the power of steam cooking? You really can't afford to miss this. Our smallest pressureless steam cooker is designed to fit on your countertop and well within your budget



**MARKET FORGE SELF-CONTAINED
TILTING ELECTRIC KETTLE**

Think there's nothing new about steam-jacketed kettles? Think again. This modular, self-contained, tilting electric kettle can save on water and energy, and it can also help you create a menu for today's health-conscious customers.

FT-6CE.....6 gallon capacity

FT-10CE.....10 gallon capacity



**MARKET FORGE
ECO-TECH**

Market Forge's new Eco-Tech™ steamer is easy to use. You just connect to your power, add 2 gallons of water, and you're ready to go. This exclusive model is only from Market Forge –the premier steam equipment manufacturer.

ET-3E.....3 pan capacity, 9 kw input

EY-5E.....5 pan capacity, 11 kw input



LINCOLN IMPINGER OVENS

Impinger Ovens provide even cooking, consistent quality and greatly reduced baking times for a wide variety of foods, including most Italian and Mexican cuisine. In the patented air impingement process, jets of high velocity air strike the food product and seal the moisture and flavor. Impinger Ovens are ideal for fast production of foods such as pizza, pasta, seafood, sandwiches and more. Available in free-standing and countertop models, and with single, double or triple deck units.



EAGLE OPEN BASE HOT FOOD TABLES

Stainless steel top and stainless steel wrapper, galvanized legs, and undershelf. Recessed control panel and standard 1-1/4" cutting board attachable to both sides of the table. All hot food tables are designed to accommodate our exclusive Flex-Master® Overshelf System, including optional heatlamp feature

606031203 Hole Electric Steam TableDHT3-120

606042404 Hole Electric Steam TableDHT4-240

606037003 Hole Gas Steam TableHT3-NG

606047004 Hole Gas Steam TableHT4-NG

Ask your RESCO rep about modular cafeteria systems, closed based hot food tables, cold food tables, portable buffet units, and a full line of accessories for your food line needs.

SUPREME METAL'S TRIUMPH HOT FOOD TABLES

The Triumph line of hot food tables offers electric and gas units. There is a gas Wet bath unit that comes with 2 - 5 wells. Cold pan units that are used to ice down cold items such as a salad bar and solid top units that are used to showcase fine foods or as beverage stands.



HF3E120

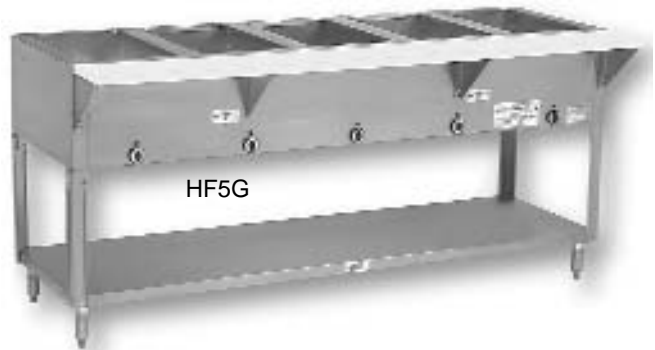

HF5G

ELECTRIC

HF-3E-120This unit comes in 2, 3, 4 & 5 wells

HF-5E-240-BSHot food table with open cabinet base.

HF-5E-240-DRHot food table with sliding doors and enclosed base

GAS

HF-3G-NAT/LPThis unit comes in 2, 3, 4 & 5 wells lengths with a stainless steel undershelf

HF-5G-NAT/LP-BS....Hot food table with open cabinet base

HF-5G-NAT/LP-DR....Hot food table with sliding doors and enclosed base



ALTO SHAAM.

ALTO-SHAAM LOW TEMP COOK & HOLD

Manual, adjustable thermostats and twelve-hour cooking timer. Single compartment oven with 20 gauge stainless steel exterior. Holds eight full-size sheet pans. Stackable design. 1000-TH-II pictured at right includes two single compartment ovens, stacked, stacking hardware and 5" heavy duty casters. 1000-TH-II3,000 watt, Single Unit
1000-TH-I.....6,000 watt, Double Unit



HALO HEAT

Alto-Shaam cook and hold ovens utilize an electric thermal cable wrapped around the entire cooking & holding chamber. This element creates a gentle blanket or halo of radiant heat surrounding food with a uniform temperature and no air movement inside the oven cavity. This patented method of low temperature cooking preserves the natural product moisture. Alto-Shaam low temperature cook and hold ovens require no outside venting or oven hoods, a major cost factor in any kitchen. With only one-third to one-half the energy consumption of a standard convection or deck oven, labor-saving set-and-forget controls, you'll see a return on your investment within a very short time.



CO-151-H-189B

CRES COR ROAST-N-HOLD™ GENTLE CONVECTION OVENS

Roast, cook, bake, rethermalize and hold with precise temperature and humidity control. Slow convected air system promotes natural browning for flavor and seals in natural juices. Moist heat, dry heat or a combination of both allows for a variety of food preparation and holding. Full 8200 Watts of power allows for rethermalizing of prepared meals or bulk items. Maximum temperature 350°F. 1850 Watt water heater with separate control and low water indicator. Energy Management Logic system electronically directs power to where it is needed most during different operating cycles. Pre-setting automatic controls for roasting and holding cycles allows for unattended operation 24 hours a day. Roast and hold over 300 lbs. (136 kg.) of meat in just 7 sq. ft. of floor space.

INSULATED HOLDING CABINETS

Fully insulated holding cabinet keeps prepared foods at serving temperatures. Powerful, yet efficient, 1500 Watt heating system maintains the right temperature to properly hold products. Heats up to 200°F.

NON-INSULATED HOLDING CABINETS

Non-Insulated holding cabinet to keep prepared foods at serving temperatures. Powerful, yet efficient, heating system maintains the right combination of heat and humidity to properly hold products. 2000 Watt heater holds foods at up to 180°F.





LAKESIDE STAINLESS STEEL 500 LB. UTILITY CARTS

Made of durable stainless steel for transport & bussing, with casters.

45017224472 Medium Duty Tubular 500lb. capacity 2 Shelf 15-1/2"x 24"

45017234473 Medium Duty Tubular 500lb. capacity, 3 Shelf 15-1/2 x 24"

450213325492 Medium Duty Tubular 500lb. capacity, 2 Shelf 21 x 33"

450213335493 Medium Duty Tubular 500lb. capacity, 3 Shelf 21 x 33"

450436422 Heavy Duty 500 lb Capacity, 3 Shelf 18 x 27"

450456411 Heavy Duty 500 lb Capacity, 3 Shelf 15-1/2 x 24"



RUBBERMAID X-TRA™ CART

Attractive styling, will hold up to 100 lb. per shelf, great for front-of-the-house.

58040914091; Open Side 300 lb Cap.,
3 Shelf 40-5/8 x 20 x 37-13/16"



METRO BC UTILITY CART

Smooth, injection-molded shelves are specially designed to resist staining and wipe clean easily.

Shelf lip contains spills, 150 lb. capacity per shelf
55516273423 Shelf 18 x 28 x 33-1/4", black



CAMBRO SERVICE CARTS

Open design service carts with 3 shelves. shelf size approx 15 x 24"; polyethylene exterior, 4" casters (4 swivel no brake), 300 lb capacity, shipped KD.

505331110....Black

505331480....Speckled Gray



CARLISLE BUS CART

Perfect for front of house or room service applications. Enclosed on 2 sides, this 3-shelf cart has 300 lb. capacity. 37-1/2 x 22 x 18". With 4 heavy non-marking swivel casters, durable plastic construction, and sturdy shelves textured for better grip and to minimize scratches.

57002036.....Black





EAGLE WIRE SHELVING

Patented QuadTruss® design makes EAGLE shelves up to 25% stronger and provides a retaining ledge for increased storage stability and product retention. Wire shelf, constructed of carbon steel or 304 stainless steel wire. Wire shelf and post are either plated or epoxy coated with applicable finish as specified.

- Chrome Posts
- Chrome Wire Shelving
- EAGLEbrite® Posts
- EAGLEbrite® Wire Shelving
- ValuGard® Wire Shelving
- ValuGard® post
- Stainless Steel Post
- Stainless Steel Wire Shelving
- Valu-Gard™ Post
- Valu-Gard™ Wire Shelving
- Valu-Master® Post
- Valu-Master® Wire Shelving

EAGLEBRITE® WIRE SHELVING

NSF listed for dry storage and heated environments. Bright zinc chloride plating followed by clear chromate plating with MasterSeal® sealer for improved rust protection. 5 year warranty.

6061203014" x 24"	60612002.....18 "x 48"
6061203114" x 30"	60612003.....18" x 54"
6061203214" x 36"	60612004.....18" x 60"
6061203314" x 42"	60612005.....18" x 72"
6061203414" x 48"	60612008.....24" x 24"
6061203514" x 54"	60612009.....24" x 30"
6061203614" x 60"	60612010.....24" x 36"
6061203714" x 72"	60612011.....24" x 42"
6061109818" x 24"	60612012.....24" x 48"
6061109918" x 30"	60612013.....24" x 54"
6061200018" x 36"	60612014.....24" x 60"
6061200118" x 42"	60612015.....24" x 72"

POSTS & ACCESSORIES

- 60612018P63-Z 63" EagleBrite Post
- 60612016P74-Z 74" EagleBrite Post
- 60612020P86-Z 86" EagleBrite Post
- 60612029P74E 74" ValuGard Post
- 60612060P63E 63" Post ValuGard
- 60612061P86E 86" Post ValuGard
- 60612017Plastic Split Sleeves (4 ea./pk)
- 60612019“S” Hook for Wire Shelving
- 60612075A204331 Plastic Shelf Marker
- 60612076CSS5P-300 Stem Caster
- 60612077CSB5P-300 Stem Caster



VALUEGARD WIRE SHELVING

Phosphate conversion coating; MasterSeal® sealer; green epoxy; NSF-listed for wet or dry storage environments. Phosphate conversion coating followed by metallic gray epoxy coating. 5 year warranty.

6061204018" x 24"
6061204118" x 30"
6061204218" x 36"
6061204318" x 42"
6061204418" x 48"
6061204518" x 54"
6061204618" x 60"
6061204718" x 72"
6061205024" x 24"
6061205124" x 30"
6061205224" x 36"
6061205324" x 42"
6061205424" x 48"
6061205524" x 54"
6061205624" x 60"
6061205724" x 72"



Wall Mount Unit

WALL MOUNT UNITS

- 60612021Wall Mount End Unit.....WB18-C
- 60612022Wall Mount Mid Unit.....DWB18-C
- 60612023Wall Mount End Unit.....WB24-C
- 60612024Wall Mount Mid Unit.....DWB24-C
- 60612025Wall End Mount Unit.....WB14-C
- 60612026Wall Mid Mount Unit.....DWB14-C

Storage & Transport



Dunnage Racks
(special order)



WINHOLT LUG TOTEALL

Ideal for transporting and storing warm or cold food products. High density, polyethylene construction. Will not rust or dent. Smooth interior and wide radius corners for easy cleaning.
555104432



MARS® AIR CURTAINS

Air curtains stabilize environments, and save energy by minimizing the heated/air conditioned air loss through open doorways. They also effectively repel flying insects, dust and pollutants. Call us to determine the right application for your needs.



Can Rack Systems
(special order)



WINHOLT CAN RACK

Convenient can rack will hold and dispense " 162 #10 cans.
25-1/4" w X 35" d X 71" h
606162 . . . CR-162 Can Rack



WINHOLT LOCKERS

From garment lockers to multi-tier locker systems, we have a selection of lockers for you needs. Special order.



WINHOLT PAN RACK

Aluminum rack will hold 18" x 20" sheet pans.
6061820



CURTRON STRIP DOOR

Slash refrigeration costs with Curtron Strip Door. Curtron Strip Doors help maintain steady holding temperatures in walk-in coolers and freezers regardless of how long or how often the door is left open. The special low-temp polar nylon reinforced vinyl straps stay flexible in the cold. Installs in minutes, with quick payback. Fits doorways up to 36"W x 78"H.

5554080

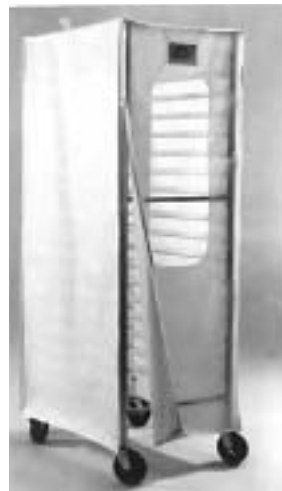

CURTRON PROTECTOR RACK COVER

Durable cover for open pan racks prevents freezer burn, dehydration and odor transfer. Helps maintain food temperature. Protects food freshness and sanitation. Made of specially reinforced fabric that is virtually indestructible. With clear window and info pocket. 23"W x 28"D x 62"H end load.

55537250



VICTORY 1 AND 2 DOOR REFRIGERATORS & FREEZERS

- Stainless steel fronts for durability
- Polished aluminum sides
- Energy efficient ABS thermal breakers around door jamb
- Adjustable 6" legs
- Recessed interior lighting
- Exterior dial thermometer
- Lifetime self-closing cam-lift hinges with 120° stay-open feature
- Self-adjusting magnetic door gaskets
- Heavy duty cylinder locks
- Durable and Energy Efficient ABS Interior Door Liners
- Environmentally friendly CFC & HCFC free refrigerants
- Field Reversible Door Swing
- Door opening accept 20" wide pan(s)
- Epoxy-coated shelves adjustable on 1" centers
- Automatic non-electric condensate disposal system
- Anti-corrosion coated evaporator coil
- Cord connected

- VSR-11-Door Refrigerator
- VSR-22-Door Refrigerator
- VSF-11-Door Freezer
- VSF-22-Door Freezer



Dimensions:	One Section Reach-in	Two Section Reach-in	Three Section Reach-in
Width, Overall:	26-1/2"	52-1/8"	77-3/4"
Depth, Overall: (incl. handles)	33-1/4"	33-1/4"	33-1/4"
Height, Overall: (incl. adj. legs)	83-5/8"	83-5/8"	83-5/8"
Depth, Door Open 120°:	56-1/2"	56-1/2"	56-1/2"



**REACH-IN BLAST CHILLER
A BLAST CHILL/STORAGE REFRIGERATOR**

The VBC-75 is ideal for small to medium size foodservice operations, which require blast chilling capability. This model is capable of chilling 75 lb of food product to 38°F in approximately 90 minutes. The comprehensive control panel features built-in alarms and can control the chilling process with the food core temperature probes or the digital timer. At the end of the blast chill cycle, the cabinet automatically defrosts and reverts to a +38°F storage mode.

VBC-75

**UNDERCOUNTER BLAST CHILLERS
A BLAST CHILL/STORAGE REFRIGERATOR**

The VBC-70 and VBC-35 are ideal last chillers when space is an issue. Capable of chilling either 35 or 70 lb of food product to 38°F in approximately 90 minutes. The comprehensive control panel features built-in alarms and can control the chilling process with the food core temperature probes or the digital timer. At the end of the blast chill cycle, the cabinet automatically defrosts and reverts to a +38°F storage mode.

VBC-3535 lb blast chill capacity

VBC-7070 lb blast chill capacity

TURBO AIR 2-DOOR REFRIGERATOR

- Exterior mounted temperature system is easy to read
- Refrigeration system is designed with oversized evaporators and condensers for faster cooling and greater efficiency
- 300 series stainless steel construction on the exterior (including top and back), and interior. ensures a bright, dent-resistant and rust-free finish for years to come
- Bottom-mounted compressor for easy service.
- Adjustable vinyl-coated wire shelves are durable, heavy duty and fully adjustable
- Elegant design with contoured lines and rounded corners
- Recessed handles
- 49 cu ft; 1/3 hp condenser
- Self-contained system—no plumbing required. Simple installation

- TSR-23SD.....1 Door Refrigerator
- TSR-49SD.....2 Door Refrigerator
- TSR-72SD.....3 Door Refrigerator
- TSF-23SD.....1 Door Freezer
- TSF-49SD.....2 Door Freezer
- TSF-72SD.....3 Door Freezer



(Available from Salt Lake inventory)



ARCTIC AIR COMMERCIAL SINGLE DOOR REACH-IN REFRIGERATOR AND FREEZER

- No it's not stainless, it's white textured steel. Less expensive. No fingerprints
- Tested and certified to ANSI/NSF Standard 7, Food Service Refrigerators and Storage Freezers. Includes NSF certified thermometer
- Two and a half inches of wall insulation make these units the most energy-efficient in the industry
- Field reversible, lockable door. Easy to convert from right to left opening
- Efficient, warm-wall condenser keeps the cabinet exterior dry without using electric heaters
- Quiet, bottom-mounted compressor. Freezer 1/3 HP, refrigerator 1/4 HP
- Environmentally friendly 134A refrigerant
- Cabinet capacity: 22 cu ft each
- External dimensions of each unit:

Height	70"
Height w/wheels	75"
Width	32"
Depth	29.3"
Depth w/door open 90°	59.8"

- 60610101Artic Air R22CW Refrigerator
- 60610102Artic Air F22CW Freezer



60610101

60610102



ICE MAKERS AND STORAGE BINS FROM IMI CORNELIUS

Producing from 200 to 2,500 lb (90 to 1,125 kg) of ice, IMI Cornelius ice makers lead the pack when it comes to quality and durability. Made for the rugged environments of the food service and hospitality industries, IMI Cornelius ice makers deliver the most performance for the lowest cost over a longer period. Whether it's a cuber, chunklet or flaker, IMI Cornelius ice making equipment always delivers a full bin of rock-solid ice. Models are available in 22", 27", 30", 44" and 48" (55 cm, 68 cm, 76 cm, 112 cm, and 121 cm) widths.

CORNELIUS ICE STORAGE BINS

- Quality construction
- One piece roto-molded cabinet
- Non-CFC foam insulation
- Corrosion proof
- Virtually indestructible
- Stainless steel door

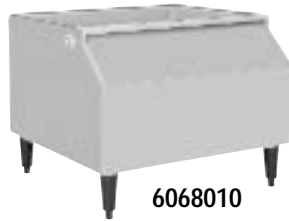

6068010



6068013



6068012

Item #	Item	Dimensions	Cert. Cube Storage Capacity	Ice Storage Capacity
6068009	B122AP Ice Storage Bin	22"W x 29"D x 23.5"H	90 lb	120 lbs
6068010	B230AP Ice Storage Bin	30"W x 32"D x 48"H	120 lb	140 lb
6068011	B430AP Ice Storage Bin	30"W x 30"D x 23.5"H	290 lb	400 lb
6068012	B530AP Ice Storage Bin	30"W x 32.25"D x 48"H	360 lb	500 lb
6068013	B1048P Ice Storage Bin	48"W x 32"D x 48"H	670 lb	1000 lb

CORNELIUS XTREME SERIES MODULAR ICE CUBER

The Xtreme family of Ice Makers are top-mounted to eliminate manual filling and match the dispensers perfectly. Both the ice maker and dispenser can be equipped with merchandisers to attract attention.

The ice harvest control system (patent pending) uses a special pressure transducer that has no moving parts and doesn't contact the water. It passed an extensive durability test that simulated 10 years of ice making (300,000 cycles) without production drift or failure.

- Environmentally safe Future Proof™ Refrigerant R-404a
- 100% front serviceability
- Programmable water control
- Compact design—22," 30," or 44"
- All stainless steel panels and frame
- Quick-change merchandising panel
- Microban® antimicrobial product protection inhibits stain and odor causing bacteria, mold and mildew.
- Cube Size: 5/8" x 7/8" x 7/8"

Ice Makers	Capacity/day
6068020XAC 322 Ice Maker air cooled	240 lb
6068022XAC 330 Ice Maker air cooled	240 lb
6068023XWC 330 Ice Maker water cooled	240 lb
6068026XAC 530 Ice Maker air cooled	405 lb
6068027XWC 530 Ice Maker water cooled	420 lb
6068028XAC 630 Ice Maker air cooled	590 lb
6068029XAC 630 Ice Maker air cooled	620 lb
6068032XWC 830 Ice Maker water cooled	710 lb
6068040XWC 1444 Ice Maker water cooled	1360 lb



6068020



6068027



6068031

TRUE GLASS DOOR REFRIGERATORS

- Exterior—durable and permanent non-peel or chip white laminated vinyl
- Interior—attractive NSF approved, white vinyl coated aluminum with stainless steel floor
- Triple pane thermal glass
- Self-contained system, no plumbing required
- Safety shielded fluorescent interior lighting for longer, brighter, shadow-free illumination
- Adjustable vinyl coated wire shelves
- Illuminated sign panel included
- Bottom mounted compressor
- Energy efficient

60600023True GDM-23 Glass 1-Door

60600047True GDM-47 Glass 2-Door



TRUE SOLID DOOR REACH IN REFRIGERATORS AND FREEZERS

- Oversized and balanced, environmentally friendly, refrigeration system, factory sealed & pre-lubricated for long life.
- Food safe refrigerators hold 33°F to 38°.
- Freezer: -10°F temp. (air off evaporator coil, -20°F)
- 300 series s/s doors and front, anodized quality aluminum ends, back and top
- Foamed-in-place polyurethane high density cell insulation (CFC free)
- Lifetime guaranteed recessed door handles
- Exterior mount digital electronic thermo. w/manual defogger
- Door locks standard
- 4" diameter swivel casters standard equipment. 6" legs avail.
- Self-contained system, no plumbing required

606231-Door RefrigeratorBottom Mount

606240001-Door RefrigeratorTop Mount

606492-Door RefrigeratorBottom Mount

606520002-Door RefrigeratorTop Mount

6062311 Door FreezerBottom Mount

606240011 Door FreezerTop Mount

6064912 Door FreezerBottom Mount

606520012 Door FreezerTop Mount



T Series with bottom mount compressor



TM Series with top mount compressor



TRUE UNDERBAR REFRIGERATION

RESCO can provide you with the undercounter set-up you need, from Direct Draw Beer Dispensers, Bottle Coolers, Glass Door Back Bar Coolers.

TDD-11 Door Direct Draw

TDD-22 Door Direct Draw

TDD-33 Door Direct Draw

TDD-44 Door Direct Draw

TBB-24-482 Door Cooler, holds 82 six-packs

TBB-24-602 Door Cooler, holds 133 six-packs

TBB-24-48G ..2 Glass Door Cooler, holds 82 six-packs

TBB-24-60G ..2 Glass Door Cooler, holds 133 six-packs





TRUE REFRIGERATED WORK TABLES

- Environmentally friendly (134A), refrigeration system, with airflow directed at pans for colder temps. Guided airflow provides uniform temperature in a 360° circle throughout cabinet for stay-fresh meats and cheeses, and colder crisper salads
- New NSF-7 listing
- All stainless steel front, top and sides; aluminum finished back
- S/S patented foam insulated cover keeps pans colder to lock in freshness—minimizes condensation
- Interior—attractive, NSF approved, white vinyl coated aluminum sides and top, coved corners and 300 series s/s floor
- Removable back hood and lid
- 5" diameter casters standard (legs available).
- Front breathing and recessed handles
- Removable cutting board of sanitary, tough, high density polyethylene
- Adjustable, heavy-duty, vinyl coated wire shelves (not available in drawer models)
- Foamed-in-place polyurethane high density cell insulation (CFC Free)
- Clear polycarbonate insert pans withstand sub-zero temperatures, dishwasher safe

- 60627121TSSU-27-12M Sandwich Refrigerator, 27", 12 Pans
- 60636800TSSU-36-8 Sandwich Unit, 36", 8 pans
- 60648120TSSU-48-12 Sandwich Refrigerator, 48", 12 pans
- 60648181TSSU-48-18M Sandwich Refrigerator, 48", 12 Pans 'M' Top
- 60660241TSSU-60-24M Sandwich Refrigerator, 60" 24 Pan, 'M' Top
- 60672301TSSU-72-30M Sandwich Refrigerator, 72", 30 Pan 'M' Top



TRUE PIZZA PREP TABLE—93" WIDE

- Optional 6" clear polycarbonate insert pans
- Doors swing within cabinet dimensions.
- Holds optional bun tray racks
- Six adjustable, heavy duty, vinyl coated wire shelves.
- 93-1/4"L x 35-1/4"D x 41-1/2"H

60693.....TPP-93, 93" Pizza Prep Table



TRUE PIZZA PREP TABLE—67" WIDE

- Door/drawer variations available
- Standard (1/3 size) 12"x6"x6" clear polycarbonate insert pans included (positioned on countertop). Drawer model accommodates 4" and 8" deep pans
- Door models holds optional bun tray racks
- Door model has adjustable, heavy duty, vinyl coated wire shelves
- Drawer models accommodate two 12"x20"x 8" pans per drawer (not included)
- 67-1/4"L x 35-1/4"D x 42"H

60667.....TPP-67, 67" Pizza Prep Table

TRUE UNDERCOUNTER REFRIGERATORS

- 60627TUC-27 1 Door, 27-5/8"L x 30-1/8"D x 29-3/4"H
 - 60648TUC-48 2 Door, 40-3/8"L x 30-1/8"D x 29-3/4"H
- Height does not include standard 6-1/4" casters or optional 6" legs





**Q Model 1000
with S-570 Bin**

MANITOWOC ICE MACHINES

The Q-Model Series 1000 Ice Cube Machines produce up to 980 lbs. per day, and stackable units go double duty for 1,960 lbs. per day. Only 30" wide. S/S exterior has the fit and finish of an appliance, and a rugged, corrosion-free base. New batch water system delivers better ice cube formation.

QR1000ARegular cubes, 770 lb., air cooled

QR1000WRegular cubes, 840 lb., water cooled

QR1002ADice cubes, 830 lb., air cooled

QR10003WDice cubes, 900 lb., water cooled

QR10004AHalf dice, 830 lb., air cooled

QR10005WHalf dice cubes, 900 lb., water cooled



KOLPAK STANDARD WALK-INS

Super door construction with smooth cam-action hinges, and a flush, air-tight fit. Five metal finishes available: galvalume, aluminum, pre-painted white steel, stainless steel, galvanized steel. Tongue-and-groove gasket assures a tight, secure fit on all panels. Vapor proof interior light is pre-wired and shatter resistant. Large, easy-to-read dial thermometer. Coved corners for easier cleaning floor joints..

Available refrigeration can be ceiling mount, pre-assembled remote, or pre-assembled charged lines.

POLAR-PAK WALK-INS

7-DAY QUICK SHIPPING!

These Kolpak Single Compartment Coolers and Freezers with pre-assembled remote refrigeration are hermetically air cooled 1-ph, 60 cycle units with outdoor package. 26 ga. stucco-embossed galvalume steel in and out, 34 x 78" standard door, right or left hinged, NSF approved .100 smooth aluminum floor. Coolers also available floorless. Standard height is 7'6". Sizes available from 6 x 6', up to 8 x 12'. Call us to order yours today.

PR 45 MOP6 x 6', 1/2 hp. cooler

PR 149 LOP6 x 6', 1-1/2 hp. cooler

PR 70 MOP6 x 10', 3/4 hp. cooler

PR 199 LOP6 x 10', 2 hp freezer

PR 70 MOP6 x 12', 3/4 hp. cooler

PR 249 LOP6 x 12', 2-1/2 hp freezer

PR 70 MOP8 x 6', 3/4 hp. cooler

PR 149 LOP8 x 6', 1-1/2 hp freezer

PR 70 MOP8 x 10', 3/4 hp. cooler

PR 249 LOP8 x 10', 2-1/2 hp freezer

PR 95 MOP8 x 12', 1 hp. cooler

PR 249 LOP8 x 11', 2-1/2 hp freezer





**FEDERAL HIGH VOLUME
DISPLAY CASES**

All-welded base construction, Danish walnut finish, glass ends and top, satin finish stainless steel trim, tempered glass front, quick clean-up with removable shelves, lights and supports. Removable glass service doors with easy glide nylon slides. White wire shelves and deck and a full length top light. Other sizes available. Avail refrigerated and non-refrigerated.

Refrigerated:

- SNR-48SC48 x 48" 1/2 hp
- SNR-59SC59 x 48" 1/2 hp
- SNR-77SC77 x 48" 3/4 hp

Non Refrigerated:

- SN-4848 x 48"
- SN-5959 x 48"
- SN-7777 x 48"

Dual:

- SN48-3SC.....48 x 48" 1/2 hp
- SN59-3SC.....59 x 48" 1/2 hp
- SN77-3SC.....77 x 48" 3/4 hp

Refrigerated Self-Serve Bakery/Deli:

- SNR-48SS48 x 48" 1/2 hp
- SNR-59SS59 x 48" 1/2 hp
- SNR-77SS77 x 48" 3/4 hp

Non-Refrigerated Self-Serve Bakery/Deli:

- SN-48-SS48 x 48"
- SN-59-SS59 x 48"
- SN-77-SS77 x 48"



SPARTAN CURVED-FRONT CASE

Clear anodized finish, tempered curved glass front, clear framed sliding glass doors, 3 wire shelves, top light, lamp and shield, shelf lighting and dark brown HPL base. Also available 40" high. Also available refrigerated. Also tilt front option.

- 910004558-3/4" x 34-5/8" x 48"R
- 910004776-3/4" x 34-5/8" x 48"R
- 910004858-3/4" x 34-5/8" x 48"N
- 910004976-3/4" x 34-5/8" x 48"N

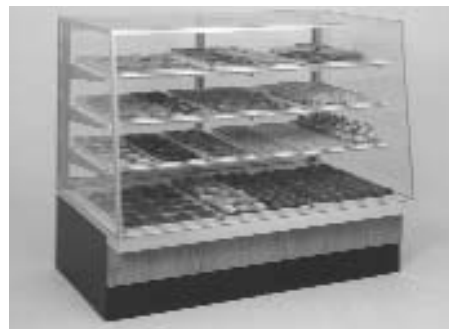

SPARTAN HI VOLUME CASE

Available refrigerated or dry. Tempered three pane glass and top, glass ends, framed, sliding two pane tempered glass doors, 3 wire shelves, top light and shield, shelf lighting, heavy duty 14 ga. steel base with brown finish. Other sizes available.

Non-Refrigerated:

- 97048-4848" x 34-3/16" x 48"
- 97048-5959" x 34-3/16" x 48"
- 97048-7777" x 34-3/16" x 48"

Refrigerated:

- 97048-48R48" x 34-3/16" x 48"
- 97048-59R59" x 34-3/16" x 48"
- 97048-77R77" x 34-3/16" x 48"



COUNTER DISPLAY CASE

Clear anodized finish, clear framed glass doors hinged, 2 glass shelves, and HPL deck.

- 9241515"L x 20"D x 24"H
- 9242929"L x 20"D x 24"H



SELF SERVE MERCHANDISER

Self closing glass doors, 4 rows of wire shelves, slide out package ledge w/tissue compartment, and adjusting bag bins.

- 9253131"L x 24"D x 36"H



DONUT CASE

Clear anodized finish, tempered curved glass front, 3 wire shelves, and oak vinyl base. Also top light or side lighting option.

- 95050-3131"L x 30"D x 50"H

Refrigeration



MASTER-BILT DELUXE CABINETS

ICE CREAM DIPPING/DISPLAY MERCHANDISERS

Removable can holders with white night-cap covers; dipper wells; removable frost shields; legs or casters; Lid locks; flavor identification tabs; condiment holders; custom colors or stainless exterior available

DD-26.....26"	DD-66.....66"
DD-46.....46"	DD-88.....88"

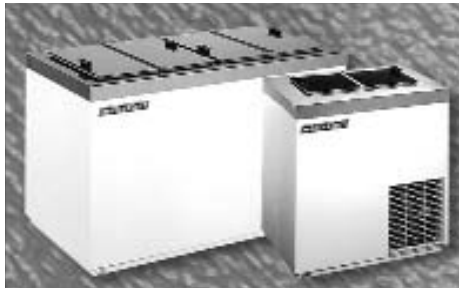

ICE CREAM STORAGE/DIPPING CABINETS

Adjustable thermostat—located in unit compartment. Cabinet finish is scratch-resistant, baked-on epoxy enamel. Sliding glass models have a single-pane tempered glass improving efficiency. Totally self contained refrigeration. Mobile—for easy clean-up

DC-2S	DC-8D
DC-4S	DC-10D
DC-4D	DC-12D
DC-6D	



JETSPRAY BEVERAGE DISPENSER

Visual display creates impulse sales, delivers dependable performance year 'round, with maximum profits in minimum space. Twin Jet® dispenser merchandises 2 flavors in one unitized Lexan bowl. 5 gallons of each flavor, unique refrigeration system provides colder beverages faster. Beverages can be sprayed or circulated depending on the nature of the drink.

JS7.....Single Flavor	JT30.....Three Flavor
JW6.....Single Flavor w/whipper	JT301.....Three Flavor w/1 whipper
JT20.....Dual Flavor	JT302.....Three Flavor w/2 whippers
JT201.....Dual Flavor w/1 whipper	JT302.....Three Flavor w/3 whippers
JT202.....Dual Flavor w/2 whippers	



LARGE CAPACITY ICE DRINK DISPENSER

- Available with eight or ten or twelve UF-1 sanitary lever or push button valves
 - Illuminated merchandiser delivers unique high impact marketing message
 - Cold plate to valve manifolding design allows for any combination or carbonated or non carbonated flavors
 - Gravity ice dispensing with positive shut off provides excellent ice targeting
 - Ice used to cool cold plate is separate from ice dispensed into cups
 - One piece ABS Thermoformed plastic ice storage hopper (DuraBide™) design provides durability and ensures all ice in hopper is dispensed
 - Unit readily accepts top mount cubers with manual ice fill capacity
 - Stainless steel cabinet
 - Multiple front access coldplate drains
 - Modular design allows for easy component access from front of unit
 - Two separate ice dispensing chutes
 - Dual agitator systems with opposite rotation ensures a full bin of ice
- Enduro 300**



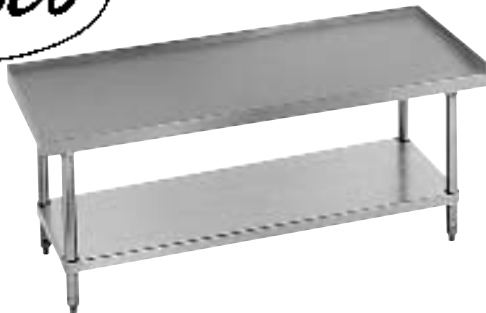

ADVANCE TABCO EQUIPMENT STANDS

Stainless steel tops, galvanized bases

60601117AG-MT-242-X Equipment Stand 24 x 24"

60601118AG-MT-302-X Equipment Stand 24 x 30"

EQUIPMENT STANDS WITH UNDERSHELVES

Stainless steel tops of 14 ga. type 302 series, 24" working height, 30" deep. Galvanized base.

60601119EG-LG-303-X Equipment Stand 3'

60601120EG-LG-304-X Equipment Stand 4'

60601121EG-LG-305-X Equipment Stand 5'

ADVANCE TABCO ECONOMY WORK TABLES

Stainless steel table tops, 30" deep.

Galvanized Legs & Plastic Feet

Galvanized Adjustable Undershelf

60601110ELAG-303 3' Work Table

60601111ELAG-304 4' Work Table

60601112ELAG-305 60' Work Table

60601113ELAG-306 6' Work Table

60601114ELAG-308 8' Work Table

Stainless Steel Table Tops, 24" deep.

Galvanized Legs & Plastic Feet

Galvanized Adjustable Undershelf

60601115ELAG-245-X Economy Work Table

60601116ELAG-246-X Economy Work Table



ADVANCE TABCO

WOOD TOP BAKERS' TABLE

2" wood top with galvanized base and undershelf.

60601122 . . . H2G-306 Bakers Table 30" x 6'



COMMERCIAL DISPOSERS

Food waste disposers are the most sanitary and environmentally friendly way to deal with waste in a food service establishment. They are best suited for a typical restaurant with a

single door dishmachine. One disposer with a pre-rinse spray can handle up to 800 dishes per hour. Salvajor Disposers are available in 3/4, 1, 1-1/2, 2, 3, 5, and 7-1/2 hp. Choose from a cone assembly (CA) or a sink assembly (SA). Easily replace any major brand disposer with Salvajor adapter kits. 1 year full replacement warranty.



SCRAP MASTER

There isn't a faster way to scrap dishes!

The ScrapMaster is designed for situations where a pre-rinse spray simply can't keep up. Making quick work of dishes and trays, the ScrapMaster is perfect for school cafeterias or any food service establishment with a medium size dishmachine. It is an excellent alternative to a fresh water trough because of its labor and water savings.

Best suited for use with single or double tank conveyor dishmachines. Available with 2, 3, 5 or 7-1/2 horsepower disposer.

COLLECTOR SYSTEMS

Rather than grinding food waste, Salvajor Collectors collect food waste solids to be disposed of in the trash. Water soluble waste is washed harmlessly down the drain reducing bulk waste and weight. Collectors recirculate water giving them the same benefits as ScrapMaster and TroughVeyor. Collectors are widely used in communities that restrict the use of food waste disposers and are safe to use with grease interceptors and septic systems.



TROUGHVEYOR

The TroughVeyor is a solution for large food service establishment where typical scrapping systems can't keep up. Multiple operators scrap into a trough of recirculating water to keep up with the largest of dishmachines. Only using the water required by one disposer, the Troughveyor

is an excellent alternative to a fresh water trough or multiple disposers. Best suited for use with double tank or flight rackless conveyor dishmachines. Available with 3, 5 or 7-1/2 horsepower disposer.



SUPREME METAL BAR SINKS

Shown is our Challenger Model 21" deep, 3-compartment sink, with deck -mount faucet, overflow pipes, stainless steel drains and molded apron for extra durability. Let us know your needs, and we'll help you find the right bar sink.
60611023 . . .3-compartment sink, 59" long, with drainboards left & right



60601069

EAGLE 314 SERIES DEEP-DRAWN COVED CORNER SINKS

Constructed of heavy gauge stainless steel, type 304 bowls, drainboards, and backsplash. Deep drawn seamless coved corner bowls, 10" backsplash. Legs crossbraced front to back. 14" water depth.
60601073 . . . Metal 314-22-3-24 Sink 3 Compt

EAGLE 412 SERIES COVED CORNER SINKS

Constructed of heavy gauge stainless steel. Type 430 bowls, drainboards, and backsplash. Deep drawn seamless coved corner bowls. 10" backsplash. Legs crossbraced front to back. 12" water depth.
60601069 . . . MM 412-16-3-18 Sink 3 Compt



EAGLE UTILITY SINK

Constructed of all 16 gauge stainless steel with rolled rim partition, 14" deep compartments, and adjustable bullet feet. 36" working height. Crumb cup strainer standard. Available in either type 304 or type 430 stainless steel. (Non-NSF)
606010752424-1-16/4 Single



POT HOOKS

Pot racks made of 300 series stainless steel. Contact your RESCO rep for custom installations.

60604400 . .Single Hook
60604401 . .Double Hook

ADVANCE TABCO HAND SINKS

Stainless steel handwashing sinks with K-52 faucet & basket.

60633000ADV 7-PS-60 Wall Mount 17" wide

60633002ADV DI-1-5 Countertop self-rim 10 x 14 x 5" bowl

60633004ADV DI-1-10 Countertop self-rim 10 x 14 x 10" bowl



60633002



60633004



60633000



JACKSON CONSERVER XL & CONSERVER XL2

The Conserver is a high-volume chemical sanitizing dish-machine built to conserve water and includes a built-in dispensing system for detergent, rinse additive, and sanitizer.

- Automatic 90 second timed wash, rinse & flush cycle
- 3 Built-in dispensing pumps
- 1.5 gal. per rack
- 74 racks per hour in XL2; 37 racks per hour in XL
- Wash/rinse thermometer
- Delimiting switch
- S/S bullet feet for leveling
- Incoming water pressure regulator
- Safety door switch



TEMPSTAR HIGH TEMPERATURE SANITIZING DISHMACHINE

The Tempstar is a fully automatic, Hi-Temp sanitizing upright dish-washer with totally electro-mechanical controls and built-in pressure regulator. Uses only 1.0 gal. of water per rack.



JPX-300H HIGH TEMPERATURE UNDERCOUNTER DISHMACHINE

Uses only 1.07 gal. of water per rack, with maximum capacity of 24 racks per hour. Two-minute totally automatic cycle. Incoming water pressure regulator; fresh water rinse rather than a recirculating rinse eliminates wash water contamination. 3/4 hp wash pump motor for excellent results.



GLASTENDER GT18+2 GLASSWASHER

Bartenders washing glasses during peak periods aren't able to wait on customers, causing missed orders and lost revenue. Free your bartender and increase profits!

- Washes up to 650 glasses per hour
- Pass-thru design
- Uses 16" round racks for speed and ease of transport
- Compact design
- Economical operation & easy maintenance

ET SERIES MULTI-USE UNDERCOUNTER DISHWASHERS

Operate a free-standing, complete warewashing center in only 48" of space! To do this, combine our ET-AF Undercounter with our Stainless Steel Table package. With 1-1/2 hp wash & rinse pump, prime switches, automatic chemical feed, 90 second complete time cycle, and hinged mounted control panel for easy service access.



AMERICAN DISH SERVICE HIGH CAPACITY 5AG

It will take care of big jobs in no time at all. Watch dirty dishes disappear! This double-duty model is designed to multiply your dishwashing capacity and your profits. Hourly capacity is 1,600 to 2,000 dishes - and it is equipped to operate with Double Racks.

ADS 3D 3-DOOR DISHWASHER

A true convertible, with the features you want, such as; top-mount controls; exterior mounted chemical pump heads; quick connect, easy service access, electrical controls; true 3-door design with only 2 doors opening in either configuration (to eliminate water on back wall and keep doors in alignment); Built-in delimiting switch; large capacity internal scrapper; no adjustment solenoid replacement; 1-1/2 hp wash & rinse pump; prime switches; automatic chemical feed; Nylatron® strips to protect S/S door.

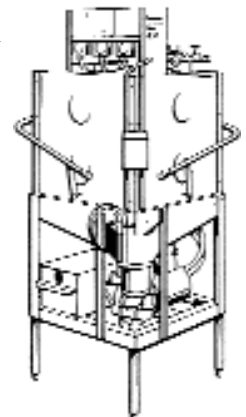



COSCO FURNITURE

Durable but lightweight furniture made of tubular aluminum.

14198 Double Folding Table

14190 Folding Table

11-839 3-Step Stool

11-835 2-Step Stool



VIRCO FOLDING TABLES

Durable folding tables with a 2/4" particle board cores fused to a melamine top in your choice of Walnut Laminate or Gray Nebula finish. No sharp steel edges with Virco's patented rolled Safe Edge®.

70760196019 30"x 72" Walnut

70760296029 30"x 96" Walnut

70760496049 35"x 96" Walnut



70766920

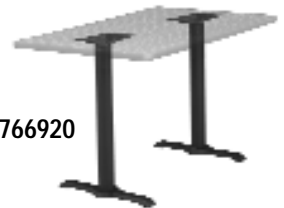

VIRCO TABLE BASES

Easily assembled cast iron pedestal bases accommodate a wide variety of tops, fitted with nylon base glides. See your RESCO rep for top choices that will suit your needs.

70766822668-22; 22" dia x 29" high

70766830668-33; 33" dia x 29" high

70766920669-20; T 20" dia x 29" high (use two for rectangular top)



70766822



 waymar



CHAIRS & STOOLS

From Stack Chairs to upholstered wood chairs; with metal and wood barstools, RESCO carries a complete selection of dining room and outdoor furniture. Ask your RESCO representative to about which style of furniture will best suit your needs and make your patrons comfortable.,



BOOTHS & CLUSTER SEATING

No matter what your clientele, RESCO will help you seat them comfortably and efficiently with our many booth and seating choices. Ask us to draw up seating plans for you.

TABLE LEVELERS

Keep your tables steady and level.

55528074 . . .Wobble Wedge (pack)

5551022 . . .Table Leveler Feet



55528074

5551022

5551022



GLOBE MIXERS

Globe's heat-treated hardened alloy gears are precision milled for increased durability and strength. The gear driven, high torque transmission ensures peak performance when mixing the thickest dough. Features include long lasting gear lubrication, three fixed gear speeds, front mounted controls, thermal overload protection, and two year parts/one year labor warranty. Standard equipment includes a stainless steel bowl, spiral dough hook, flat beater, stainless steel wire whip, bowl guard, 15 minute timer and #12 attachment hub (except for the SP8).

SP30



COUNTER MIXERS

SP88 Quart Mixer
 SP1010 Quart Mixer
 SP2020 Quart Mixer

FLOOR MODELS

SP2525 Quart Mixer
 SP3030 Quart Mixer
 SP30P30 Quart Pizza Mixer
 SP40P40 Quart Mixer (single or three phase)
 SP60P60 Quart Mixer (single or three phase)



SP8

MEDIUM DUTY

GC51010" Compact Manual
 GC51212" Compact Manual

LIGHT DUTY

GC99" Compact Manual
 GC1010" Compact Manual
 GC1212" Compact Manual
 GC12D12" Compact Manual



GLOBE HEAVY DUTY SLICERS

RESCO offers a full range of Globe meat slicers from compact manuals to heavy duty manual or automatic units with state of the art features. Whether slicing is a significant part of your daily routine or very minimal, Globe has a slicer to best suit your needs.

- 3600.....Manual
- 3850.....Two Speed Automatic
- 3975.....Variable Speed Automatic
- 4600.....Manual (Protech Series)
- 4850.....Two Speed Automatic (Protech Series)
- 4975.....Variable Speed Automatic (Protech Series)



4975



827E



BERKEL COMPACT MEAT SLICERS

- Precise slice thickness adjustment
- Permanently mounted knife sharpener
- Easy to clean
- Less counter space portable size.
- Available 1/4 and 1/3 hp



825E

Mixers & Processors



CUISINART DLC-X PLUS™ FOOD PROCESSOR

The Cuisinart® DLC-X Plus Food Processor provides unmatched performance and durability. The extra large 20 cup capacity work bowl is perfect for catering and restaurant use.

55510003DLC-XP X
Plus Food Processor



CUISINART PREP 7™ FOOD PROCESSOR

'The right choice for everyday food prep. Big enough to process plenty of ingredients, and sized for exceptionally easy handling. With trademark features like the wide, one-piece feed tube and accessories for virtually any processing task, this Cuisinart® mid-size food processor is ready for everyday in every kitchen.'
DLC-7SFP Food Preparation



ROBOT-COUP R6N FOOD PROCESSORS

Single base units complete with easy-to-clean s/s bowl to cut, chop, mix, blend, pate, puree and knead doughs. Heavy duty continuous feed attachment, uses 34 different processing plates to slice, dice, grate and julienne.

R6N.....6 qt. (as pictured)
R4N.....4 qt.



ROBOT-COUPÉ POWER HAND MIXER

Power Mixers are ideal for liquefying soups, sauces, pureeing fruits/vegetables, and preparing the smoothest of patés in just minutes! Removable stainless steel knife blade promotes superior cleaning to eliminate food particles and bacteria that could become lodged in shaft. Easily prepare the smoothest soups and sauces, fruit/vegetable purees, pancake/waffle batter, and patés in just minutes.

60601045MP450 Hand Cutter/Mixer



NOVON MX91 MIXER

A blending mixer with 5-25 gal. capacity, operating at 8,300 rpm. Overall length 28", immersible sleeve length 16"; weighs 7.6 lbs; 280 watts.
special order....MX-91 Dynamic Mixer



ROBOT-COUPÉ FOOD PROCESSOR

1/2 hp motor unit with a continuous feed attachment to shred, dice, slice, grate and julienne in various sizes.

Available with a bowl attachment designed for vertical cutting and mixing: chop, puree, blend, mix and knead dough.

- 60601095R-2N Vert Cut/Mixer with Attachment
- 60601096R-207 Discharge Plate Only
- 91618202R-202 Cutter Bowl Only (R2)
- 91618203R-203 "S" Knife Assembly Only (R2)
- 91618204R-204 Cutter Bowl Lid Only
- 91618205R-205N Cont. Feed Lead (New)
- 91618206R-206 Cont. Feed Attachment
- 91618209R-209 Medium 1/8" Grating Plate
- 91618211R-211 4MM 3/16" Slicing Plate
- 91618228R-228N Large Vegetable Pusher
- 91618229R-849 Small Vegetable Pusher



PROFESSIONAL 6 QT BOWL-LIFT MIXER WITH 525 WATT MOTOR & POURING SHIELD

Tool of the professional chef. Enhanced electronic sensor, 10-speed control. Soft Start™ mixing feature. Hinged hub cover for additional attachments. Clear 2-piece pouring shield
60641086 . . . KP2671X 6 Quart White Pro Mixer



K5 HEAVY DUTY MIXER

325 watt motor, Easy-to-use bowl-lift handle, 10-speed solid-state control. 5 qt S/S bowl with handle; includes flat beater, dough hook and wire whip. Power hub for additional attachments.
60641078 . . . K5SS-WH White 5 Qt.. Mixer



CLASSIC STAND MIXER WITH 250 WATT MOTOR & TILT-UP HEAD

4-1/2 qt capacity, 250 watt motor, tilt-up head, 10-speed solid-state control.
60641085 . . . K45SS 4.5 Qt. Mixer



KITCHENAID 5-SPEED CLASSIC PLUS HAND MIXER

Easy-to-use 5 speed control. Powerful enough to mix double batches of cookie dough. Stainless steel liquid blender rod. Comfortable ergonomically, electronic mixing sensor.
60641096 . . . KHM5TBWH Kitchen-Aid Hand Mixer



KITCHENAID MIXER ATTACHMENTS

- 60641013 . . . RVS-A Rotor Slice/Shredder
- 60641075 . . . K5ADH Dough Arm for K5A Mixer
- 60641076 . . . FG-A Food Grinder Attachment
- 60641077 . . . K5AWW Wire Whip
- 60641079 . . . K5AR 5 Quart Beater
- 60641081 . . . K45-WW S/S Whip F/K45
- 60641082 . . . SN/FG-A Pasta Maker and Food
- 60641083 . . . KPS2CL Pouring Shield
- 60641084 . . . K45-B Beater



Mixers & Slicers



UNIVEX HEAVY DUTY PREP MATE

Designed for heavy duty use, the Prep-Mate* does not bog down even on the toughest loads. Driven by a 1 HP motor with a 1" wide Poly-V belt system, our Prep-Mate is a tough but quiet kitchen performer. A 5" deep prep container with cover comes standard with this unit. A vegetable slicer for cutting, a VS9H for shredding, and/or a meat & food chopper attachment can be used on this unit. As with all Univex products, the Prep-Mate is engineered with maximum price/value for years of trouble free performance. This unit is UL listed and NSF approved.



- PM91PrepMate Power Drive
- VS9.....VS9 Shred/Grate attachment
- VS9H.....Vs9H Vegetable Slicing Housing
- ALMFC12.....Univex MFC12 Meat Grinder attachment



HOBART MIXERS

RESCO sells and services the entire line of Hobart mixers. Hobart mixers have set the industry standard for more than 75 years, thanks to their reliability, durability, versatility and outstanding performance. Each model—from the diminutive five-quart tabletop version to the colossal 140-quart floor model—also offers several innovative safety features and an easy-to-clean design. No matter how much punishment your kitchen dishes out, Hobart mixers keep going long and strong.

MIXER ATTACHMENTS

- 5301000012-HOB-76-CCA Complete Chopper
- 53010001VS-99S-HOB Vegetable SL
- 53010002VS-99H-HOB Economy Housing
- 53010003VS-99D-HOB Economy Door
- 53010004VS-12KDS-HOB "S" Knife Disc
- 53010005VS-12DH-HOB Disc Holder
- 53010006VS-12SD-HOB 1/2" Shred Disc
- 53010007VS-12SD-HOB 3/16" Shred Disc
- 53010008VS-12SD-HOB 3/32" Shred Disc
- 53010009VS-12SC-HOB 5/16" Shred Disc
- 53010010VS-12GD-HOB Grater Disc
- 53010011GS-99 Grater Attachment Comp
- 60641025FMB-20 20 Quart Mixer Bowl S/S
- 60641026DWHIP-SST220 Wire Whip 20 Quart
- spec. order ...FMR-30 30 Quart Mixer Bowl S/S
- 53010020Intedge #12 Chopping Knives
- 5301002212/22-P76 Stomper Intedge
- 5301002512H-1/8" 1/8" Chopper Plate
- 5301002712H-3/8" 3/8" Chopper Plate
- 5301002812H-3/16" 3/16" Chopper Plate
- 5301002912H-1/4" 1/4" Chopper Plate





CAPTIVE-AIRE HOOD SYSTEMS

Captive-Aire has been manufacturing quality ventilation packages for over 26 years. Our integrated systems are engineered for maximum performance, safety, and energy efficiency. Captive-Aire's diverse product line enables you to specify exactly what you need for your total kitchen ventilation needs.



The Direct Gas Fired Make-Up Air package is designed to deliver tempered make-up air for installations requiring frequent air changes. Units are designed for natural and propane gas applications, and for indoor or outdoor installation.

AD Series



Captive-Aire's flagship ND hood is a wall canopy exhaust-only unit that operates at low CFM. It is UL Listed for use over 450°F, 600°F, and 700°F cooking surface temperatures.

ND



The Air Handler Unit is the heart of the modular fan system. It is designed to deliver fresh outside make up air for installations requiring frequent air changes. Units are designed for indoor or outdoor applications, and are available in vertical or horizontal discharge configurations. Available in sizes up to 22,000 CFM, and external static pressures up to 2" W.G.

A Series

FLAME GARD TYPE 3 GREASE FILTER

- Available in stainless steel, galvanized steel, and aluminum.
- Unique frameless design with full filter height baffles to maximize the filter's available capture area while at the same time increasing the filter's free area.
- Unlike competitive products, our full filter height baffles eliminate dead air space at top & bottom of filter.
- Filters 100% of grease laden air 100% of the time.
- Impossible for grease laden air to short-circuit or avoid making turns through full filter height overlapping baffle system.
- Realistic, tested static pressures.
- 2 handles included.
- 2-piece die-stamped construction makes baffles a structural part of the filter.
- U.L. classified, made in the U.S.A., and competitively priced to meet your budget
- All type 3 filters are 1 1/2" thick.

555940Baffle Filter 20"H x 16"W

555941Baffle Filter 20"H x 20"W

555942Baffle Filter 20"H x 25"W

555943Baffle Filter 16"H x 20"W

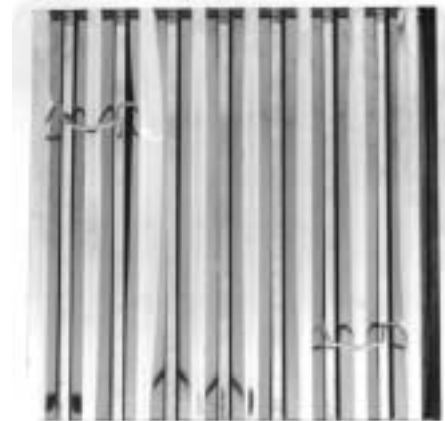

BAFFLE BOSS FILTER REMOVAL TOOL

Remove and install baffle filters quickly, safely and easily with this handy 6' tool. Made of nickel plated steel, breaks down for easy storage.

special order.....FMP 129-1061



Venting Systems

Ask your **RESCO**
contract design expert how
SPRING AIR REV-LOW ventilators
can **SAVE YOU MONEY!**

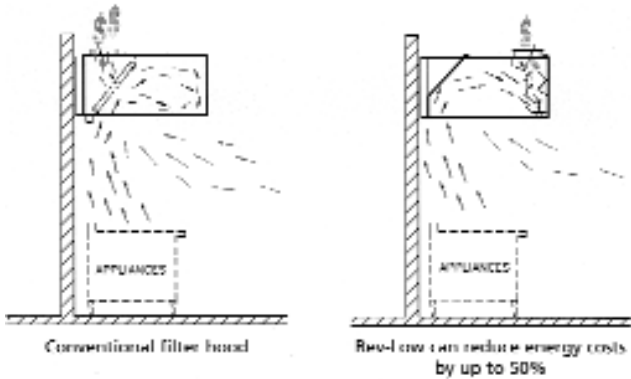

Spring Air
Exhaust Energy Calculations
Restaurant & Store

Description	Rev-Low Exhaust	Straight Exhaust
Engineering Data Summary		
Total Hood Exhaust		
Heated Kitchen Fresh Air (cfm)	1550	2880
Kitchen Heater Capacity (btu/hr)	1240	2304
Heated Dining Room Fresh Air (cfm)	140566	261181
Dining Room Heating (btu/hr)	310	576
Net Exhaust from Building (cfm)	35142	65295
Energy Cost Data		
Cost to heat Kitchen Fresh Air	\$2,098	\$3,899
Cost to heat Dining Room Fresh Air	\$525	\$975
Total Annual Heating Cost	\$2,623	\$4,874
Energy Savings When Using Rev-Low		\$2,250

The Spring Air Rev-Low hood is a revolutionary idea in commercial kitchen ventilator design. Rev-Low saves you valuable heating and air conditioning dollars by minimizing and controlling the total exhaust air over individual appliances across the entire hood section.

The Rev-Low allows you to not only fine tune each section to whatever specific appliances you have under it now, but gives you total flexibility to add, subtract or replace them in the future, knowing you'll have the right exhaust volume to do the job.

Spring Air exhaust systems save you money!

 **Spring Air**
YOUR KITCHEN EXHAUST EXPERTS

- Wash water Ventilators
- Dry Ventilators
- Rev-Low
- Filter Hoods
- Surface Fire Suppression
- Commercial Kitchen Exhaust Fans
- Commercial Kitchen Supply Units
- Kitchen Enviro Systems

A		Broilers178-179, 189, 195	Coffee servers58-62	Dishers.....127
Adapter bar.....112	Broom holder167	Colander, pan.....14	Colanders.....116	Dishracks.....156
Adapter plate.....114	Brooms174	Condiment dispenser.....67	Condiment jar.....95	Dishwashing systems 169-170
Air curtains.....203	Brushes.....153, 155, 164	Condiments.....75	Convection ovens.....188-191, 200	Disinfectants169-171
Airpot59, 60	Brushes, wok.....124	Conveyer ovens.....199	Cookie cutters.....121	Dispenser, beverage....57, 211
Apple divider.....136	Bubble popper.....120	Cooking disk119	Cool handles.....101	Dispenser, foil/film.....155
Aprons143	Bucket opener.....167	Coolers, walk in209	Cork extractor.....65	Dispenser, ketchup132
Ashtrays41, 43, 95	Bucket, wine.....67	Corkscrews65	Corn poppers177	Dispenser, napkin89
Au gratin.....86	Buffet bars.....52	Cover, cake.....95	Cover, chafer49	Dispenser, pancake.....123
B		Cover, rack203	Cover, telescope102	Dispenser, sanitary napkin.172
Bagel board123	Bun pans.....109-110	Covers, basting.....136	Covers, pastry.....95	Dispenser, straw89
Bags.....161	Bus boxes.....98-99	Covers, pan.....106	Creamers83, 87	Dispensers, box160
Bains marie.....114, 141	Butane.....51	Crocks.....55	Cruet.....39, 41, 82	Dispensers, cup160
Bake pans.....108-110	Butter melter.....87	Crumb sweeper.....89	Cup cake pans109-110	Dispensers, syrup83
Baker supplies.....117-123	C		Cup dispensers160	Display cases.....210
Bamboo baskets94	Cabinets, holding.....200	Candles.....50	Cups, measure117	Display pans111-113
Banana split.....40	Caddy, bar75	Cappucino dispenser63	Cutlery, disposable161	Disposers212
Bar mat.....66-67	Café trays80	Carafe.....39, 43, 60	Cutter, donut.....121	Dome cover49
Bar mixes75	Cake cover.....95	Card holders89, 96	Cutter, fry133	Donut cutter.....121
Bar spoon66	Cake decorating.....122	Carpet care169-171	Cutter, pizza.....120	Double boilers105
Bar strainer66	Call bell137	Carts98-99, 201	Cutters, cookie.....121	Dough boxes.....119
Bar towel75	Camcart53	Case, pastry95	Cutting boards...67, 145, 147	Dough cutter.....149
Basket, taco132	Camchiller53	Cast iron platter.....90	Cylinder.....99	Dough scraper120
Basket, tostoda132	Can liners161	Cater trays77-79	D	
Baskets92-94	Can opener134	Chafers48-49	Decanter39, 43	Degreaser170-171
Baskets, fry.....107	Can rack203	Chairs215	Delivery bag.....120	Deodorizer, air.....168
Basting cover.....136	Candles.....50	Champagne bucket.....67	Dessert.....39-44	Deveiner137
Bell137	Cappucino dispenser63	Char broilers178-179, 189, 195	Dicer.....132-133	Dinnerware.....5-17
Beverage dispenser.....57	Carafe.....39, 43, 60	Checks, guest.....159	Dinnerware guide24	Dinnerware, disposable162
Beverage dispenser.....211	Card holders89, 96	Cheese cutter135	Dipper.....126	Dipwell.....126, 181
Beverage service.....57-62	Carpet care169-171	Cheese shaker.....84	Dish boxes.....98-99	Dish machines214
Bin, ingredient.....142	Carts98-99, 201	Cheese warmers178-179	Dish, aluminum.....77	Dishers.....127
Bin, silver.....98-99	Case, pastry95	China5-17	E	
Bin, ingredient.....	Cast iron platter.....90	China caps115	Easel97	Egg beater.....137
Blenders.....69-72,184-185	Chafers48-49	Chocolate dispenser63	Egg poacher.....137	Egg slicer.....137
Board, bagel123	Chairs215	Chopper135	Escargot.....14	Equipment stand.....212
Boards, cutting145, 147	Champagne bucket.....67	Clam shells.....86	Exhaust.....2, 220-221	Faucet, dipwell.....181
Boilers105	Char broilers178-179, 189, 195	Cleaners164, 169-171	F	
Booster seats.....100	Checks, guest.....159	Cleavers.....124, 149	Faucets155, 165-166	Fiberglass trays.....80
Booths.....215	Cheese cutter135	Coats.....143	Film161	Filter hood220
Bottle opener.....65	Cheese shaker.....84	Cocktail shaker.....66	Filter paper162	Filter powder162
Bouillon strainer.....115	Cheese warmers178-179			
Bowl, aluminum.....77	China5-17			
Bowl, glass.....39-44	China caps115			
Bowl, punch39, 41, 47	Chocolate dispenser63			
Bowl, soup.....96	Chopper135			
Bowls, disposable.....162	Clam shells.....86			
Bowls, plastic....78, 90-91, 96	Cleaners164, 169-171			
Bowls, s/s116	Cleavers.....124, 149			
Bowls, salad.....90-91, 96	Coats.....143			
Boxes142	Cocktail shaker.....66			
Braziers.....107				
Bread pan109				

- Food carriers53, 57
Food containers.....141-142
Food pans111-113
Food processors.....217
Food warmers176-179
Fork, meat45, 46
Fork, pasta56
Fork, snail.....87
Forks, cook's.....149-152
Fountain jar181
Freezers204-209
French whips125
Fry baskets107
Fry bottom pan107
Fry cutter133
Fry pans101
Fryer filter193
Fryers192-194
Fryers, counter.....180
Fuel holder49
Fuel, lamp.....50
Funnels67, 121
Furniture215
- G**
- Garbage cans.....172-173
Garbage disposers212
Garlic pres135
Garnishers135-136
Gas connectors165
Gas match.....51
Glass cleaner71
Glass racks156
Glass rimmer67
Glass washers72, 214
Glassware25-44
Globe cover167
Gloves144, 176
Gloves, disposable.....158
Graters135-136
Grates109, 112
Gravy boats86
Griddles.....178-179, 195
Grill scraper.....155
Grinder, meat.....132, 219
Gripper, pan.....120
Guides24, 64
Guest checks.....159
- H**
- HACCP.....154
Hair net.....158
Handles, cool.....101
Hanger, glass75
- Hats143, 158
Heat bulbs.....167
High chairs100
Holding cabinets.....200
Hoods220
Hoses165
Hot dog grills177
Hot food tables199
Hot pads92, 144
Hot plates178, 195
Housekeeping products...179-171
- I**
- Ice cream cabinets211
Ice cream disher127
Ice machines.....206, 209
Ice molds47
Ice pick66
Ice scoop.....168
Icing grate.....109
Impinger oven199
Ingredient bin142
Insets.....114
- J**
- Jar, condiment95
Jet Spray63, 211
Jiggers.....68
Juice dispenser63
Juicers.....73, 134
- K**
- Ketchup collector82, 132
Kettles, steam.....196-198
Knife racks147
Knife sharpeners.....146
Knife, bar.....67
Knives147-152
Knives, pizza120
Koffee-King.....62
- L**
- Ladles .45-47, 55-56, 124,126
Lamp fuel50
Lamps50
Laundry products169-171
Lemon squeezer66
Light bulbs167
Linens16
Liner, shelf.....67
Liquor control.....68
Liquor dispenser.....68, 76
Liters39, 73
- M**
- Mallet, meat.....131
Malt cup66
Margarita salt rimmer.....67
Mandoline.....133
Mashers131
Mat, baking123
Mat, bar66-67
Matting, floor163
Matting, shelf165
Measurement guide64
Measures.....118
Measuring cups117
Measuring spoons.....117
Meat chopper.....132
Meat fork.....45, 46
Meat loaf pans.....109-110
Meat mallets131
Meat tenderizers131
Melamine.....17
Menu boards96-97
Menu covers89
Menu holders89
Message boards.....96-97
Microwaves.....182-183
Mints.....157
Mitts144
Mixer attachments....218-219
Mixer, hand137, 218
Mixers184,185, 216-219
Mixers, drink.....69-72
Mixing bowls.....116
Molcajate.....85
Mold, patty131
Molds, ice47
Money tray69
Mop buckets173
Mops.....174
Muddler67
Muffin pans109-110
Mugs.....15
- N**
- Nacho warmer179
Napkin dispenser.....89
Napkin holder.....75
Napkins.....159
- O**
- Oil & vinegar39, 41, 82
Onion king.....133
Opener, bucket.....167
Openers65, 134
- Order racks155
Oven, pizza.....190,199
Oven, steam.....182
Ovens186-191, 199, 200
Ovens, cook /hold200
Ovens, Impinger199
Overflow tube.....167
Oyster Cocktail.....40
Oyster cup86
- P**
- Paddles130
Pail.....141, 154
Pan carrier53
Pan grates109, 112
Pan gripper120
Pan racks203
Pancake dispenser123
Pans101-114
Pasta cooker19, 105
Pastry brushes.....153
Pastry covers95
Pastry decorating.....122-123
Patty mold131
Peelers135
Peels120
Peppermills.....81
Percolators.....61
Piano whips125
Picks75
Pie markers.....121
Pitchers.....39, 73, 83, 87
Pizza cutter120
Pizza oven190
Pizza pans119
Pizza screens119
Pizza supplies.....119-120
Place mats.....159
Plates, glass39-44
Plates, disposable162
Poacher137
Pom tong129
Popcorn poppers.....177
Portion control.....68
Portion servers.....127
Pot hooks.....213
Potato cutters133
Pots.....103-106
Pre rinse units.....166
Prep tables208
Pressure cooker107
Pumps, condiment181
Punch bowls.....39, 41, 47

R	Sharpeners146	Steamers.....177, 183, 196-198	Towel, bar.....75
Rack, can203	Shears136	Sterno50	Towels143
Rack, knife147	Sheet pans.....109	Stirrers75	Trash containers172-173
Rack, pan.....203	Shelf liner.....67, 165	Stock pots.....103-104	Tray stands100, 167
Rack, pizza pan119	Shelving.....202	Stools.....215	Trays69, 77-80
Ramekins14-15, 41, 85	Sherbet39-44, 86	Storage boxes142	Trays, aluminum.....77
Ranges.....186-189	Shrimp deveiner137	Store 'N Pour68	Trays, bar.....69
Ranges, counter180	Sieve117	Stove, induction.....51	Trays, disposable161
Rapi-Kool.....154	Sifter117	Stove, portable.....51	Trays, plastic78-80
Rarebits14-15	Signs.....96-97	Strainer, bar66	Trays, stainless79
Refrigerators204-209	Silv-a-tainer.....99	Strainers.....115	Tumblers, plastic88
Rice cooker.....180	Silverware17-24	Straw dispenser89	Turners137, 148-152
Rimmer.....67	Sinks.....72, 213	Straw pads92	
Roast pans108-109	Skewers136, 157	Straws161	U
Roaster oven.....180	Skillet, serving.....90	Strip doors203	Urns172
Rolling pins121	Skillets, iron106	Sugar dispenser84	Urinal screen167
	Skimmers.....117	Sugar holder.....14-15, 40	Utility carts.....201
S	Slicers216	Supreme bowls40	Utility tongs.....129
Salad bowls90-91, 96	Slicers, egg137	Syrup dispensers.....83	
Salad service90-91, 96	Slicers, vegetable.....133	Syrup jars181	V
Salad spinner155	Snail fork.....87		Vegetable insets114
Salad spoon90	Sneeze guard52, 54	T	Ventilation.....2, 220-221
Salsa bowl85	Soaps169-171	Table bases215	Votive, glass40
Salt & pepper14, 41, 81	Soup bowl.....96	Table linens16	
Sand urn172	Soup crock.....15	Table skirting.....16	W
Sanitizers164	Spatulas.....130, 137, 148-152	Tablecloths, paper.....159	Walk ins.....209
Sauce boat86	Speed rail.....74	Tables, folding.....215	Warmers176-179
Sauce cups.....86	Spoon, bar66	Tables, work212	Washers, glass72
Sauce pots103-106	Spoon, buffet56	Taco basket.....132	Waste containers172-173
Saw, meat152	Spoon, salad90	Tart pan.....123	Water station.....166
Scales138-139	Spoon, serving.....45, 46	Tea brewer60	Wedgers.....132-133
School trays.....80	Spoons128, 137	Teapot14-15, 58-60, 87	Whips125
Scissor tong129	Spoons, measure.....117	Tenderizer, meat131	Willow baskets93
Scoop, coffee.....135	Squeegees174	Test strips.....164	Wine buckets67
Scoop holder.....167	Squeeze dispensers.....82	Thermobarrier.....53	Wine chillers.....67
Scoop, fry132	Squeezer66	Thermometers139-140	Wire racks.....156
Scoops74, 121	Stand pipe.....167	Thermo-Platters90	Wire shelving202
Scrapers.....120, 130, 137	Stand, cake95	Timers.....138	Wobble wedge167
Scrap block.....136	Stand, wine67	Toasters.....175	Woks124
Screens, pizza119	Stands, tray.....100, 167	Tomato cutters.....132-133	Work tables.....212
Seating.....215	Steak knives23	Tong45, 46, 56, 129, 137	Woven baskets93-94
Seats, booster.....100	Steak markers158	Toothpick dispensers..87, 157	Wringers, mop.....173
Servers, portion127	Steak weights131	Toothpicks157	
Shaker, cheese84	Steam kettles196-198	Tortilla server85	Z
Shaker, cocktail66	Steam over183, 196-198	Totes98, 203	Zester.....135
Shakers118	Steam pans.....111-113	Towel dispensers159	

© Restaurant & Store Equipment Company
 230 West 700 South
 Salt Lake City, UT 84101
 801-364-1981

Catalog Design & Production by Volcano Studio
www.volcanostudio.net
 888-665-6220